

# Installation Instructions for FIB1-1000TS

## FIB1-1000 Series 1000BASE-TX / 1000BASE-SX/LX

### Fiber Transceiver Converters

#### Description

The **FIB1-1000TS** provides an SFP socket for industry standard SFP module for your fiber optic cable and an RJ-45 connector for 1000Base-TX twisted pair cable connection. These units will automatically tailor themselves to convert both half-duplex or full-duplex signals depending on your specific network needs. You may also set the FX side in full-duplex only or half-duplex only. The Fiber Converters give you the freedom to extend your 1000Mbps cabling distance by allowing connectivity up to 2Km in multi-mode or 80Km in single mode. Six LED indicators signal the power status of the converter, UTP port, Link/RX and duplex status.

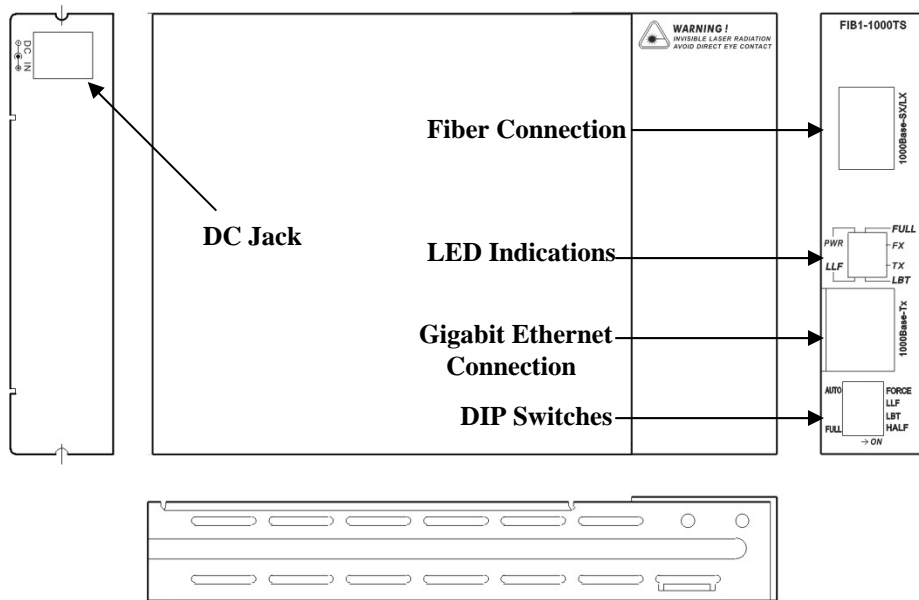

#### Front Panel DIP Switch Setting

Full / Half : The Fiber and UTP Duplex will be configured in Full-duplex or Half-duplex  
 \* This switch includes an "Auto Reset" function so the power-reset is not necessary when any modification is made here.

LBT-Loop Back Test ( OFF -> Not active ; ON -> active )  
 \* If the Local side loop-back test is active then LEDs will all flash quickly and refresh to display the remote side status.  
 \*\*Note: This application must be run only when the remote side loop-back testing function is off.

LLF- Link Loss Forwarding ( OFF -> Not active ; ON -> active )  
 \* More detail, please check the next page.

Auto/Force : The Fiber will either support auto negotiation link pattern or not  
 \*When the DIP switch is set at "OFF", the auto negotiation function is enabled.  
 \*\*When connecting FIB1-1000TS to another FIB1-1000TS in point to point application, please set to "Force Mode".  
 When connecting FIB1-1000TS to other fiber equipment, set to "Auto Mode", if the link will not work in "Force Mode"

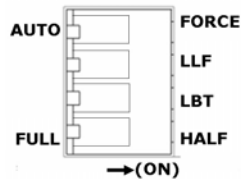

#### Specifications

##### Standard

IEEE802.3ab 1000Base-TX, IEEE802.3z 1000Base-SX/LX, Gigabit Standards  
 Supports Full Duplex Ethernet mode (2000Mbps)

##### 1000BASE-TX RJ-45 Connectors

One RJ-45 connector is provided for connection to either MDI-X (To PC) or MDI (To HUB) equipment. Utilizing Auto MDI/MDIX allows all UTP connections to be made using only a common straight-through UTP cable.

##### RJ-45 Pin

- 5
- 4
- 3
- 6
- 1
- 2
- 7
- 8

##### 568-A type

- Pair1-Tip
- Pair1-Ring
- Pair2-Tip
- Pair2-Ring
- Pair3-Tip
- Pair3-Ring
- Pair4-Tip
- Pair4-Ring

##### 568-B type

- Pair1-Tip
- Pair1-Ring
- Pair3-Tip
- Pair3-Ring
- Pair2-Tip
- Pair2-Ring
- Pair4-Tip
- Pair4-Ring

##### Environment

Temperature : 0°C – 50°C  
 Humidity 10-90% non condensing

##### Dimension

122.6mm x 85.6mm x 20mm  
 (H x W x D)

##### Power

+12V / 1A maximum  
 DC plug type : center Positive

##### 1000BASE-TX UTP Cable

Cable type: 1000Base-TX; 4 pair, Cat. 5, EIA/TIA-568, STP/UTP

Maximum cable distance: 100 meters (328 feet)

##### Fiber Optic Connector

SFP socket is provided.  
 SFP module is optional.

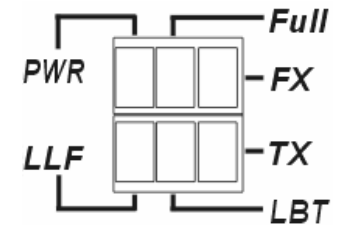

##### LED Indicators

LED	Function	State	Status
PWR	Power indicator	On Off Blinking	Converter has power. Converter has no power. Loop back testing and Get CPE status function enable.
Full	mode display	On Off	Full duplex mode (2000Mbps). Half-duplex mode
FX	Fiber link	On Off Blinking	The fiber link is ok. No link or the link is faulty. Receiving data on the fiber.
LBT	mode display	Blinking	Loop back testing and Get CPE status function enable.
LLF	mode display	On Off	Loop back testing and Get CPE status function disable. Link loss forwarding function enable.
TX	Ethernet link	On Off Blinking	Link loss forwarding function disable The UTP link is ok. No link or the link is faulty. Receiving data on Ethernet.

## Installation

Connect the fiber interface cable to the FIB1-1000. Using a straight through or cross UTP cable, connect the Ethernet connection to the appropriate RJ-45 jack. Set the "Duplex" switch (full and half) according to the specifications of your equipments. Follow the connection examples below. Install the fiber converter with the DC power adapter provided (+12VDC) and connect the adapter to an AC outlet.

## Connections

The following example illustrates the connection scheme when connecting from a 1000BASE-TX port of one HUB to a 1000BASE-SX/LX port of another HUB through the fiber converter.

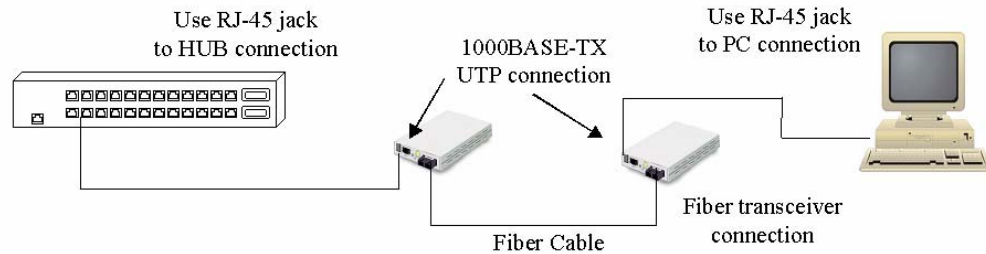
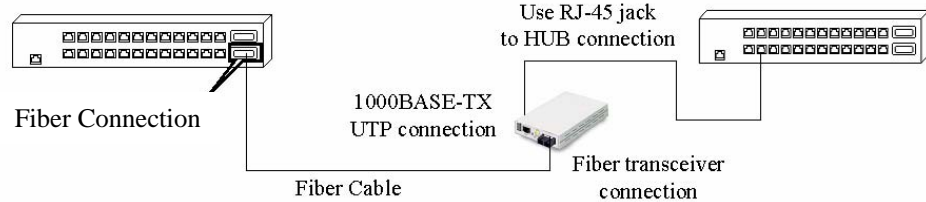

The following example illustrates the connection scheme when connecting from a 1000BASE-TX port of one HUB to a 1000BASE-TX Network Interface Card (NIC) in a computer through the fiber converter.

## Link-Loss-Forwarding (LLF) Application Note

This media converter incorporates a Fiber Link Forwarding feature which allows indirect sensing of a Fiber Link Loss via the 1000 Base-TX UTP connection. Whenever the media converter detects a Link Loss condition on the Receive fiber (Fiber LNK OFF), it disables its UTP transmitter so that a Link Loss condition will be sensed on the receive UTP port. (See the following figure) The link loss can then be sensed and reported by a Network Management agent at the remote UTP port's host equipment.

This feature has no effect on the media converter's UTP LNK LED, which continues to function normally, independent of the state of the Fiber LNK LED and the UTP transmitter.

This feature is disabled by default on all the FIB1-1000 family media converters.

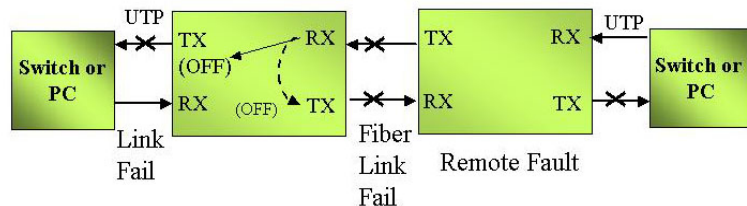

Figure : Fiber Break Responses

## Loop-back Testing(LBT)& Get CPE status Application Note :

**( While this feature is operating the fiber side transmission will be halted )**

This media converter incorporates a Fiber Loop-back Testing feature which allows the system to confirm that the fiber or Ethernet circuit loop is complete or not. The local-side unit will send out a detect message which includes both command and test-pattern data to the remote-side unit and request for an answer. When the remote-side unit receives the message, first it will try to recognize the command. After the remote-side unit recognizes the command message, then it will deliver the received test-pattern data back to the local-side unit. In this way, the circuit loop is complete. This feature is enabled by the DIP switch#2 on the front panel.

The get remote side status feature allows the system (both available for FIB1 & FRM301 series application) to monitor the remote side status. First, the unit will send out a message which includes a command to the remote side unit and request for an answer. When the remote side unit receives the message, first it will try to recognize the command. After the remote side unit recognizes the command message, it will deliver the remote side status back to the rack mount unit. In this way, the rack mount unit can easily monitor every remote side unit. The remote side status message include the fiber side - link status and duplex status, the UTP side - link status, duplex status and speed status, the power status, transmission status and fiber (Tx side) failure status.

The FIB1 series is compatible with FRM301 series on this feature so you may test the whole application with FIB1 & FRM301.

Situation 1 : If the local side can not access to remote side under LBT is running then only the power LED will still flash rapidly alone.

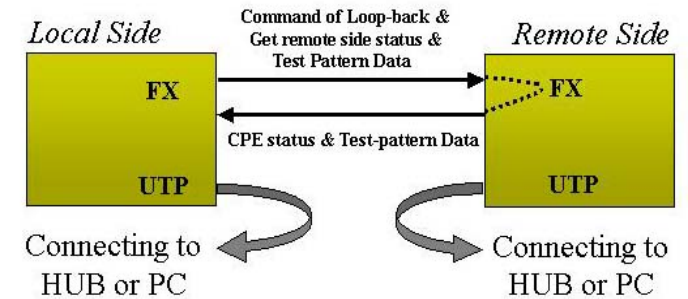

## TRADEMARKS

Ethernet is a registered trademark of Xerox Corp.

ST® is a registered trademark of AT&T.

## WARNING:

This equipment has been tested and found to comply with the limits for a Class A digital device, pursuant to Part 15 of the FCC Rules. These limits are designed to provide reasonable protection against harmful interference when the equipment is operated in a commercial environment. This equipment generates, uses, and can radiate radio frequency energy and if not installed and used in accordance with the instruction manual may cause harmful interference in which case the user will be required to correct the interference at his own expense. NOTICE: (1) The changes or modifications not expressly approved by the party responsible for compliance could void the user's authority to operate the equipment. (2) Shielded interface cables and AC power cord, if any, must be used in order to comply with the emission limits.

## CISPR PUB.22 Class A COMPLIANCE:

This device complies with EMC directive of the European Community and meets or exceeds the following technical standard. EN 55022 - Limits and Methods of Measurement of Radio Interference Characteristics of Information Technology Equipment. This device complies with CISPR Class A.

## WARNING:

This is a Class A product. In a domestic environment this product may cause radio interference in which case the user may be required to take adequate measures.

## CE NOTICE

Marking by the symbol CE indicates compliance of this equipment to the EMC directive of the European Community. Such marking is indicative that this equipment meets or exceeds the following technical standards: EN 55022:1994/A1:1995/A2:1997 Class A and EN61000-3-2:1995, EN61000-3-3:1995 and EN50082-1:1997 Ver. 1.0