

User Manual



IGS-1604XSM

IGS-1604XSM-16PH

Industrial Gigabit Ethernet 20-Port
Managed Non-PoE & PoE Switches



CTC UNION TECHNOLOGIES CO., LTD.

LEGAL

The information in this publication has been carefully checked and is believed to be entirely accurate at the time of publication. CTC Union Technologies assumes no responsibility, however, for possible errors or omissions, or for any consequences resulting from the use of the information contained herein. CTC Union Technologies reserves the right to make changes in its products or product specifications with the intent to improve function or design at any time and without notice and is not required to update this documentation to reflect such changes.

CTC Union Technologies makes no warranty, representation, or guarantee regarding the suitability of its products for any particular purpose, nor does CTC Union assume any liability arising out of the application or use of any product and specifically disclaims any and all liability, including without limitation any consequential or incidental damages.

CTC Union products are not designed, intended, or authorized for use in systems or applications intended to support or sustain life, or for any other application in which the failure of the product could create a situation where personal injury or death may occur. Should the Buyer purchase or use a CTC Union product for any such unintended or unauthorized application, the Buyer shall indemnify and hold CTC Union Technologies and its officers, employees, subsidiaries, affiliates, and distributors harmless against all claims, costs, damages, expenses, and reasonable attorney fees arising out of, either directly or indirectly, any claim of personal injury or death that may be associated with such unintended or unauthorized use, even if such claim alleges that CTC Union Technologies was negligent regarding the design or manufacture of said product.

WARNING:

This equipment has been tested and found to comply with the limits for a Class A digital device, pursuant to Part 15 of the FCC Rules. These limits are designed to provide reasonable protection against harmful interference when the equipment is operated in a commercial environment. This equipment generates, uses, and can radiate radio frequency energy and if not installed and used in accordance with the instruction manual may cause harmful interference in which case the user will be required to correct the interference at his own expense. NOTICE: (1) The changes or modifications not expressly approved by the party responsible for compliance could void the user's authority to operate the equipment. (2) Shielded interface cables and AC power cord, if any, must be used in order to comply with the emission limits.

This is a Class A product. In a domestic environment this product may cause radio interference in which case the user may be required to take adequate measures.

IGS-1604XSM, IGS-1604XSM-16PH Series

Industrial Grade Managed Ethernet Switches

User Manual

Version 0.9b

May 2023

This manual supports the following models:

IGS-1604XSM

IGS-1604XSM-16PH

CTC Union Technologies Co., Ltd.

Far Eastern Vienna Technology Center (Neihu Technology Park)

8F, No. 60, Zhouzi St.

Neihu, Taipei, 114

Taiwan

Phone: +886-2-2659-1021

FAX: +886-2-2799-1355

This document is the current official release manual. Contents are subject to change without prior notice. Please check CTC Union's website for any updated manual or contact us by E-mail at sales@ctcu.com. Please address any comments for improving this manual or to point out omissions or errors to marketing@ctcu.com. Thank you.

©2023 CTC Union Technologies Co.,Ltd.

All Rights Reserved

The contents of this document are subject to change without any prior notice.

TABLE OF CONTENTS

CHAPTER 1. INTRODUCTION	19
1.1 WELCOME	19
1.2 PRODUCT DESCRIPTION.....	19
1.2.1 IGS-1604XSM	19
1.2.2 IGS-1604XSM-16PH(E)	20
1.3 PRODUCT FEATURES.....	20
1.4 PRODUCT SPECIFICATIONS	21
CHAPTER 2. PANELS & INSTALLATION	23
2.1 VIEWS OF PANELS.....	23
2.2 LAN CONNECTIONS	24
2.3 FIBER CONNECTIONS	24
2.4 CONSOLE PORT CONNECTION	25
2.4.1 RJ-45 Pin Assignment.....	25
2.5 POWER CONNECTION	26
2.6 ALARM RELAY CONNECTION.....	26
2.7 DIGITAL INPUT (DI) CONNECTION.....	27
2.8 EARTH GROUND CONNECTION.....	27
2.9 LED INDICATORS	28
2.10 INSTALLATION.....	29
2.10.1 Mounting	29
2.10.2 Un-mounting.....	29
CHAPTER 3. INTRODUCTION TO CLI	30
3.1 GENERAL INTRODUCTION	30
3.2 ACCESS CONNECTION	30
3.2.1 Telnet Operation.....	30
3.2.2 CONSOLE Operation.....	30
3.3 CLI MODES.....	31
3.4 QUICK KEYS	31
3.5 COMMAND SYNTAX	32
3.6 BASIC CONFIGURATIONS	32
3.6.1 Configuring IPv4 Address	32
3.6.2 Enter Config Interface Mode	33
3.6.3 Save Configurations	33
3.6.4 Restart the Device.....	33
3.6.5 Load Factory Defaults	34
3.6.6 Show System and Software Information	34
3.6.7 Show Running Configurations.....	35
3.6.8 Show History Commands.....	35
3.6.9 Help.....	36
3.6.10 Logout	36
3.7 COMMANDS IN USER MODE	37
3.7.1 > clear ip acd	37
3.7.2 > clear ipv6 dhcp relay statistics	37
3.7.3 > enable	37
3.7.4 > exit	37
3.7.5 > help	38
3.7.6 > logout	38
3.7.7 > ping ip	38
3.7.8 > ping ipv6.....	39
3.7.9 > traceroute ip	39
3.7.10 > traceroute ipv6	41
3.7.11 show commands	42
3.8 COMMANDS IN EXEC MODE.....	42

3.8.1 # alarm suppress <alarm_name>.....	42
3.8.2 # clear	42
3.8.2.1 # clear access management statistics.....	42
3.8.2.2 # clear access-list ace statistics.....	42
3.8.2.3 clear cfm meps [domain <md_name>] [service <ma_name>] [mep-id <mepid>] statistics	42
3.8.2.4 # clear dot1x statistics	42
3.8.2.5 # clear erps	43
3.8.2.6 # clear ip acd.....	43
3.8.2.7 # clear ip arp.....	43
3.8.2.8 # clear ip dhcp detailed statistics	43
3.8.2.9 # clear ip dhcp server binding <ip>.....	43
3.8.2.10 # clear ip dhcp server binding { automatic manual expired }.....	44
3.8.2.11 # clear ip dhcp server statistics.....	44
3.8.2.12 # clear ip dhcp snooping statistics.....	44
3.8.2.13 # clear ip igmp snooping.....	44
3.8.2.14 # clear ip statistics	44
3.8.2.15 # clear ipv6 mld snooping.....	44
3.8.2.16 # clear ipv6 neighbors	44
3.8.2.17 # clear ipv6 statistics	45
3.8.2.18 # clear known-host-keys.....	45
3.8.2.19 # clear lacp statistics.....	45
3.8.2.20 # clear lldp statistics	45
3.8.2.21 # clear logging.....	45
3.8.2.22 # clear mac address-table.....	45
3.8.2.23 # clear mvr.....	45
3.8.2.24 # clear port-security dynamic.....	46
3.8.2.25 # clear spanning-tree.....	46
3.8.2.26 # clear statistics	46
3.8.2.27 # clear system led status	46
3.8.3 # config terminal	46
3.8.4 # copy.....	46
3.8.5 # delete	48
3.8.6 # dir	48
3.8.7 # disable & # enable.....	48
3.8.8 # dot1x	49
3.8.9 # erps	49
3.8.10 # firmware.....	49
3.8.10.1 # firmware swap.....	49
3.8.10.2 # firmware upgrade.....	49
3.8.11 # ip dhcp retry interface vlan	50
3.8.12 # more.....	50
3.8.13 # ping	50
3.8.13.1 # ping ip	50
3.8.13.2 # ping ipv6	51
3.8.14 # reload	52
3.8.14.1 # reload cold.....	52
3.8.14.2 # reload defaults.....	52
3.8.15 # send.....	52
3.8.16 # terminal.....	53
3.8.16.1 # terminal editing	53
3.8.16.2 # terminal exec-timeout.....	53
3.8.16.3 # terminal history size	53
3.8.16.4 # terminal length	54
3.8.16.5 # terminal width	54
3.8.17 traceroute	54
3.8.17.1 # traceroute ip.....	54
3.8.17.2 # traceroute ipv6	55
3.8.18 # veriphy	56

3.8.19 # show interface (<port_type> [<v_port_type_list>]) utp-cable-diagnostic.....	56
3.8.20 show commands.....	57
3.9 COMMANDS IN CONFIG MODE	57
3.9.1 (config)# aaa	57
3.9.1.1 (config)# aaa accounting	57
3.9.1.2 (config)# aaa authentication login.....	57
3.9.1.3 (config)# aaa authorization	58
3.9.2 (config)# access management	58
3.9.2.1 (config)# access management	58
3.9.2.2 (config)# access management<access_id>.....	58
3.9.3 (config)# access-list.....	59
3.9.3.1 (config)# access-list ace	59
3.9.3.2 (config)# access-list ace update	60
3.9.3.3 (config)# access-list rate-limiter	61
3.9.4 (config)# aggregation mode.....	61
3.9.5 (config)# banner.....	62
3.9.5.1 (config)# banner [motd] <banner>	62
3.9.5.2 (config)# banner exec <banner>.....	62
3.9.5.3 (config)# banner login <banner>	62
3.9.6 (config)# cfm	62
3.9.6.1 (config)# cfm domain	62
3.9.6.1.1 (config-cfm-dmn)# format	62
3.9.6.1.2 (config-cfm-dmn)# interface-status-tlv	63
3.9.6.1.3 (config-cfm-dmn)# organization-specific-tlv	63
3.9.6.1.4 (config-cfm-dmn)# port-status-tlv.....	63
3.9.6.1.5 (config-cfm-dmn)# port-status-tlv.....	64
3.9.6.1.6 (config-cfm-dmn)# sender-id-tlv	64
3.9.6.1.7 (config-cfm-dmn)# level	65
3.9.6.1.8 (config-cfm-dmn)# service	65
3.9.6.1.8.1 (config-cfm-dmn-svc)# continuity-check interval	65
3.9.6.1.8.2 (config-cfm-dmn-svc)# format.....	65
3.9.6.1.8.3 (config-cfm-dmn-svc)# interface-status-tlv	66
3.9.6.1.8.4 (config-cfm-dmn-svc)# organization-specific-tlv	66
3.9.6.1.8.5 (config-cfm-dmn-svc)# port-status-tlv	66
3.9.6.2 (config)# cfm interface-status-tlv	67
3.9.6.3 (config)# cfm organization-specific-tlv	67
3.9.6.4 (config)# cfm port-status-tlv.....	67
3.9.6.5 (config)# cfm sender-id-tlv	67
3.9.7 (config)# clock.....	68
3.9.7.1 (config)# clock summer-time <word16> date	68
3.9.7.2 (config)# clock summer-time <word16> recurring	68
3.9.7.3 (config)# clock timezone.....	69
3.9.8 (config)# ddmi.....	69
3.9.9 (config)# default access-list rate-limiter	70
3.9.10 (config)# dot1x.....	70
3.9.10.1 (config)# dot1x system-auth-control.....	70
3.9.10.2 (config)# dot1x re-authentication	70
3.9.10.3 (config)# dot1x authentication timer re-authenticate	71
3.9.10.4 (config)# dot1x timeout tx-period	71
3.9.10.5 (config)# dot1x authentication timer inactivity.....	71
3.9.10.6 (config)# dot1x timeout quiet-period.....	72
3.9.10.7 (config)# dot1x feature.....	72
3.9.10.8 (config)# dot1x guest-vlan.....	73
3.9.10.9 (config)# dot1x guest-vlan supplicant	73
3.9.10.10 (config)# dot1x max-requth-req	73
3.9.11 (config)# enable	74
3.9.11.1 (config)# enable password	74
3.9.11.2 (config)# enable password level	74

3.9.11.3 (config)# enable secret	74
3.9.12 (config)# erps <inst>	74
3.9.12.1 (config-erps)# admin-state { enable disable }	75
3.9.12.2 (config-erps)# control-vlan <vid> [pcp <pcp>]	75
3.9.12.3 (config-erps)# guard-time <guard_time>	76
3.9.12.4 (config-erps)# hold-off-time <hold_off>	76
3.9.12.5 (config-erps)# level <level>	76
3.9.12.6 (config-erps)# node-id <node_id>	76
3.9.12.7 (config-erps)# port0 interface <port_type> <port>	77
3.9.12.8 (config-erps)# port0 sf-trigger { link { mep domain <md_name> service <ma_name> mep-id <mepid> } }	77
3.9.12.9 (config-erps)# port0 smac <mac>	77
3.9.12.10 (config-erps)# port1 interface <port_type> <port>	78
3.9.12.11 (config-erps)# port1 sf-trigger { link { mep domain <md_name> service <ma_name> mep-id <mepid> } }	78
3.9.12.12 (config-erps)# port1 smac <mac>	78
3.9.12.13 (config-erps)# protected-vlans <vlan_list>	78
3.9.12.14 (config-erps)# revertive	79
3.9.12.15 (config-erps)# ring-id <ring_id>	79
3.9.12.16 (config-erps)# ring-type { major sub-ring [virtual-channel] interconnected-sub-ring { connected-ring <connected_ring_inst> [virtual-channel] [propagate-topology-change] } }	79
3.9.12.17 (config-erps)# rpl { owner neighbor } { port0 port1 }	80
3.9.12.18 (config-erps)# version { v1 v2 }	80
3.9.12.19 (config-erps)# wait-to-restore <wtr>	80
3.9.13 (config)# green-ethernet	81
3.9.13.1 (config)# green-ethernet led interval	81
3.9.13.2 (config)# green-ethernet led on-event	81
3.9.13.3 (config)# green-ethernet eee optimize-for-power	81
3.9.14 (config)# gvrp	82
3.9.14.1 (config)# gvrp	82
3.9.14.2 (config)# gvrp max-vlans	82
3.9.14.3 (config)# gvrp time	82
3.9.15 (config)# hostname	83
3.9.16 (config)# interface	83
3.9.16.1 (config)# interface (<port_type> [<plist>])	83
3.9.16.2 (config)# interface llag	84
3.9.16.2.1 (config-llag)# lacp failover	84
3.9.16.2.2 (config-llag)# lacp max-bundle	85
3.9.16.3 (config)# interface vlan	85
3.9.17 (config)# ip	85
3.9.17.1 (config)# ip arp inspection	85
3.9.17.2 (config)# ip arp inspection entry interface	85
3.9.17.3 (config)# ip arp inspection translate	86
3.9.17.4 (config)# ip arp inspection vlan	86
3.9.17.5 (config)# ip arp inspection vlan <in_vlan_list> logging	87
3.9.17.6 (config)# ip dhcp excluded-address	87
3.9.17.7 (config)# ip dhcp pool	87
3.9.17.7.1 (config-dhcp-pool)# broadcast	88
3.9.17.7.2 (config-dhcp-pool)# client-identifier	88
3.9.17.7.3 (config-dhcp-pool)# client-name	88
3.9.17.7.4 (config-dhcp-pool)# default-router	89
3.9.17.7.5 (config-dhcp-pool)# dns-server	89
3.9.17.7.6 (config-dhcp-pool)# domain-name	89
3.9.17.7.7 (config-dhcp-pool)# hardware-address	90
3.9.17.7.8 (config-dhcp-pool)# host	90
3.9.17.7.9 (config-dhcp-pool)# lease	90
3.9.17.7.10 (config-dhcp-pool)# netbios-name-server	91
3.9.17.7.11 (config-dhcp-pool)# netbios-node-type	91
3.9.17.7.12 (config-dhcp-pool)# netbios-scope	91
3.9.17.7.13 (config-dhcp-pool)# network	92

3.9.17.7.14 (config-dhcp-pool)# nis-domain-name.....	92
3.9.17.7.15 (config-dhcp-pool)# nis-server	92
3.9.17.7.16 (config-dhcp-pool)# ntp-server	93
3.9.17.7.17 (config-dhcp-pool)# vendor class-identifier	93
3.9.17.8 (config)# ip dhcp relay	93
3.9.17.9 (config)# ip dhcp relay information option.....	94
3.9.17.10 (config)# ip dhcp relay information policy {drop keep replace}.....	94
3.9.17.11 (config)# ip dhcp server	94
3.9.17.12 (config)# ip dhcp snooping	95
3.9.17.13 (config)# ip dns proxy	95
3.9.17.14 (config)# ip domain name.....	95
3.9.17.15 (config)# ip helper-address.....	96
3.9.17.16 (config)# ip http secure-certificate	96
3.9.17.17 (config)# ip http secure-server	96
3.9.17.18 (config)# ip http secure-redirect.....	96
3.9.17.19 (config)# ip igmp host-proxy.....	97
3.9.17.20 (config)# ip igmp snooping	97
3.9.17.21 (config)# ip igmp snooping vlan.....	97
3.9.17.22 (config)# ip igmp ssm-range	98
3.9.17.23 (config)# ip igmp unknown-flooding	98
3.9.17.24 (config)# ip name-server	98
3.9.17.25 (config)# ip route	99
3.9.17.26 (config)# ip routing	99
3.9.17.27 (config)# ip source binding interface	100
3.9.17.28 (config)# ip ssh.....	100
3.9.17.29 (config)# ip verify source	101
3.9.17.30 (config)# ip verify source translate	101
3.9.18 (config)# ipmc	101
3.9.18.1 (config)# ipmc profile	101
3.9.18.2 (config)# ipmc profile <profile_name>	101
3.9.18.3 (config)# ipmc range.....	102
3.9.18.4 (config-ipmc-profile)# default range	102
3.9.18.5 (config-ipmc-profile)# description	102
3.9.18.6 (config-ipmc-profile)# range.....	103
3.9.19 (config)# ipv6	103
3.9.19.1 (config)# ipv6 dhcp snooping	103
3.9.19.2 (config)# ipv6 dhcp snooping uh-unknown	104
3.9.19.3 (config)# ipv6 mld host-proxy.....	104
3.9.19.4 (config)# ipv6 mld host-proxy leave-proxy	105
3.9.19.5 (config)# ipv6 mld snooping	105
3.9.19.6 (config)# ipv6 mld snooping vlan.....	106
3.9.19.7 (config)# ipv6 mld ssm-range	106
3.9.19.8 (config)# ipv6 mld unknown-flooding	106
3.9.19.9 (config)# ipv6 route	107
3.9.19.10 (config)# ipv6 source binding interface	107
3.9.20 (config)# lacp system-priority	108
3.9.21 (config)# line	108
3.9.21.1 (config)# line.....	108
3.9.21.2 (config-line)# do	109
3.9.21.3 (config-line)# editing	109
3.9.21.4 (config-line)# end	109
3.9.21.5 (config-line)# exec-banner.....	110
3.9.21.6 (config-line)# exec-timeout	110
3.9.21.7 (config-line)# exit.....	110
3.9.21.8 (config-line)# help.....	111
3.9.21.9 (config-line)# history size.....	111
3.9.21.10 (config-line)# length	111
3.9.21.11 (config-line)# location.....	112

3.9.21.12 (config-line)# motd-banner	112
3.9.21.13 (config-line)# privilege level	113
3.9.21.14 (config-line)# width	113
3.9.22 (config)# lldp	114
3.9.22.1 (config)# lldp holdtime	114
3.9.22.2 (config)# lldp reinit	114
3.9.22.3 (config)# lldp timer	114
3.9.22.4 (config)# lldp transmission-delay	115
3.9.22.5 (config)# lldp med datum	115
3.9.22.6 (config)# lldp med fast.....	116
3.9.22.7 (config)# lldp med location-tlv altitude	116
3.9.22.8 (config)# lldp med location-tlv civic-addr	117
3.9.22.9 (config)# lldp med location-tlv elin-addr	118
3.9.22.10 (config)# lldp med location-tlv latitude	118
3.9.22.11 (config)# lldp med location-tlv longitude	119
3.9.22.12 (config)# lldp med media-vlan-policy	119
3.9.23 (config)# logging	120
3.9.23.1 (config)# logging on	120
3.9.23.2 (config)# logging host	120
3.9.23.3 (config)# logging level.....	121
3.9.24 (config)# loop-protect.....	121
3.9.24.1 (config)# loop-protect	121
3.9.24.2 (config)# loop-protect shutdown-time	121
3.9.24.3 (config)# loop-protect transmit-time	122
3.9.25 (config)# mac	122
3.9.25.1 (config)# mac address-table aging-time	122
3.9.25.2 (config)# mac address-table learning vlan.....	123
3.9.25.3 (config)# mac address-table static.....	123
3.9.26 (config)# monitor session	124
3.9.27 (config)# mvr.....	124
3.9.27.1 (config)# mvr	124
3.9.27.2 (config)# mvr name <mvr_name> channel.....	125
3.9.27.3 (config)# mvr name <mvr_name> frame priority	125
3.9.27.4 (config)# mvr name <mvr_name> frame tagged.....	126
3.9.27.5 (config)# mvr name <mvr_name> last-member-query-interval.....	126
3.9.27.6 (config)# mvr name <mvr_name> mode	127
3.9.27.7 (config)# mvr vlan <v_vlan_list>	127
3.9.27.8 (config)# mvr vlan <v_vlan_list> channel	128
3.9.27.9 (config)# mvr vlan <v_vlan_list> frame priority.....	128
3.9.27.10 (config)# mvr vlan <v_vlan_list> frame tagged.....	129
3.9.27.11 (config)# mvr vlan <v_vlan_list> last-member-query-interval.....	129
3.9.27.12 (config)# mvr vlan <v_vlan_list> mode.....	130
3.9.27.13 (config)# mvr vlan <v_vlan_list> { election igmp-address <v_ipv4_ucast> }.....	130
3.9.28 (config)# ntp.....	131
3.9.28.1 (config)# ntp	131
3.9.28.2 (config)# ntp server	131
3.9.29 (config)# poe (For PoE Models Only)	132
3.9.29.1 (config)# poe capacitor-detect	132
3.9.29.2 (config)# poe supply	132
3.9.29.3 (config)# poe management mode	132
3.9.30 (config)# port-security	133
3.9.30.1 (config)# port-security	133
3.9.30.2 (config)# port-security aging	133
3.9.30.3 (config)# port-security aging time	134
3.9.30.4 (config)# port-security hold time.....	134
3.9.31 (config)# privilege	135
3.9.32 (config)# prompt.....	135
3.9.33 (config)# qos	136

3.9.33.1 (config)# qos map cos-dscp	136
3.9.33.2 (config)# qos map dscp-classify	137
3.9.33.3 (config)# qos map dscp-cos	137
3.9.33.4 (config)# qos map dscp-egress-translation.....	138
3.9.33.5 (config)# qos map dscp-ingress-translation.....	139
3.9.33.6 (config)# qos qce refresh	140
3.9.33.7 (config)# qos qce update	140
3.9.33.8 (config)# qos storm.....	142
3.9.34 (config)# radius-server	143
3.9.34.1 (config)# radius-server attribute 32	143
3.9.34.2 (config)# radius-server attribute 4	143
3.9.34.3 (config)# radius-server attribute 95	143
3.9.34.4 (config)# radius-server deadtime	144
3.9.34.5 (config)# radius-server host.....	144
3.9.34.6 (config)# radius-server key	145
3.9.34.7 (config)# radius-server retransmit.....	145
3.9.34.8 (config)# radius-server timeout.....	145
3.9.35 (config)# ring.....	146
3.9.35.1 (config)# ring <instance> chain.....	146
3.9.35.2 (config)# ring <instance> ring	147
3.9.35.3 (config)# ring <instance> sub.....	147
3.9.36 (config)# rmon	148
3.9.36.1 (config)# rmon alarm	148
3.9.36.2 (config)# rmon event	149
3.9.37 (config)# snmp-server	149
3.9.37.1 (config)# snmp-server	149
3.9.37.2 (config)# snmp-server access	150
3.9.37.3 (config)# snmp-server community	150
3.9.37.4 (config)# snmp-server contact.....	151
3.9.37.5 (config)# snmp-server engine-id local	151
3.9.37.6 (config)# snmp-server host.....	151
3.9.37.6.1 (config-snmps-host)# host <v_ipv6_ucast>.....	152
3.9.37.6.2 (config-snmps-host)# host <v_ipv4_ucast>.....	152
3.9.37.6.3 (config-snmps-host)# version.....	153
3.9.37.6.4 (config-snmps-host)# informs retries.....	153
3.9.37.6.5 (config-snmps-host)# shutdown	154
3.9.37.7 (config)# snmp-server location.....	154
3.9.37.8 (config)# snmp-server security-to-group.....	154
3.9.37.9 (config)# snmp-server trap	155
3.9.37.10 (config)# snmp-server user.....	155
3.9.37.11 (config)# snmp-server view	156
3.9.38 (config)# spanning-tree.....	157
3.9.38.1 (config)# spanning-tree aggregation	157
3.9.38.1.1 (config-stp-aggr)# spanning-tree.....	157
3.9.38.1.2 (config-stp-aggr)# spanning-tree auto-edge	157
3.9.38.1.3 (config-stp-aggr)# spanning-tree bpdu-guard.....	157
3.9.38.1.4 (config-stp-aggr)# spanning-tree edge	158
3.9.38.1.5 (config-stp-aggr)# spanning-tree link-type.....	158
3.9.38.1.6 (config-stp-aggr)# spanning-tree mst <instance> cost.....	158
3.9.38.1.7 (config-stp-aggr)# spanning-tree mst <instance> port-priority.....	159
3.9.38.1.8 (config-stp-aggr)# spanning-tree restricted-role.....	159
3.9.38.1.9 (config-stp-aggr)# spanning-tree restricted-tcn	159
3.9.38.2 (config)# spanning-tree edge bpdu-filter	159
3.9.38.3 (config)# spanning-tree edge bpdu-guard.....	160
3.9.38.4 (config)# spanning-tree mode	160
3.9.38.5 (config)# spanning-tree mst <instance> priority <prio>	161
3.9.38.6 (config)# spanning-tree mst <instance> vlan <v_vlan_list>.....	161
3.9.38.7 (config)# spanning-tree mst forward-time	162

3.9.38.8 (config)# spanning-tree mst max-age.....	162
3.9.38.9 (config)# spanning-tree mst max-hops.....	163
3.9.38.10 (config)# spanning-tree mst name	163
3.9.38.11 (config)# spanning-tree recovery interval	163
3.9.38.12 (config)# spanning-tree transmit hold-count	164
3.9.39 (config)# switchport.....	164
3.9.39.1 (config)# switchport vlan mapping <group ID> <vlan_list> <translation_vlan>	164
3.9.39.2 (config)# switchport vlan mapping <group ID> { both ingress egress } < vid > <translation_vlan>.....	165
3.9.40 (config)# tacacs-server	165
3.9.40.1 (config)# tacacs-server timeout.....	165
3.9.40.2 (config)# tacacs-server deadtime	166
3.9.40.3 (config)# tacacs-server key	166
3.9.40.4 (config)# tacacs-server host	166
3.9.41 (config)# upnp.....	167
3.9.41.1 (config)# upnp	167
3.9.41.2 (config)# upnp advertising-duration.....	167
3.9.41.3 (config)# upnp static interface vlan	167
3.9.42 (config)# username	168
3.9.42.1 (config)# username { default-administrator <input_username> } privilege <priv> password encrypted	168
3.9.42.2 (config)# username<username>privilege<priv>password none	168
3.9.42.3 (config)# username<username>privilege<priv>password unencrypted	169
3.9.43 (config)# vlan	170
3.9.43.1 (config)# vlan	170
3.9.43.2 (config)# vlan ethertype s-custom-port.....	170
3.9.43.3 (config)# vlan protocol	170
3.9.44 (config)# web privilege group	171
3.10 COMMANDS IN CONFIG INTERFACE MODE	173
3.10.1 (config-if)# access-list	173
3.10.1.1 (config-if)# access-list action	173
3.10.1.2 (config-if)# access-list logging.....	173
3.10.1.3 (config-if)# access-list mirror	173
3.10.1.4 (config-if)# access-list policy.....	174
3.10.1.5 (config-if)# access-list port-state	174
3.10.1.6 (config-if)# access-list rate-limiter	174
3.10.1.7 (config-if)# access-list shutdown	174
3.10.1.8 (config-if)# access-list { redirect port-copy }	175
3.10.2 (config-if)# aggregation group	175
3.10.3 (config-if)# dot1x	175
3.10.3.1 (config-if)# dot1x port-control.....	175
3.10.3.2 (config-if)# dot1x guest-vlan.....	176
3.10.3.3 (config-if)# dot1x radius-qos	176
3.10.3.4 (config-if)# dot1x radius-vlan	177
3.10.3.5 (config-if)# dot1x re-authenticate	177
3.10.4 (config-if)# duplex.....	177
3.10.5 (config-if)# excessive-restart	178
3.10.6 (config-if)# flowcontrol	178
3.10.7 (config-if)# frame-length-check	178
3.10.8 (config-if)# green-ethernet	179
3.10.8.1 (config-if)# green-ethernet eee	179
3.10.8.2 (config-if)# green-ethernet urgent-queues	179
3.10.8.3 (config-if)# green-ethernet energy-detect	179
3.10.8.4 (config-if)# green-ethernet short-reach	179
3.10.9 (config-if)# gvrp.....	180
3.10.10 (config-if)# ip.....	180
3.10.10.1 (config-if)# ip arp inspection check-vlan.....	180
3.10.10.2 (config-if)# ip arp inspection logging	180
3.10.10.3 (config-if)# ip arp inspection trust	180
3.10.10.4 (config-if)# ip dhcp snooping trust	181

3.10.10.5 (config-if)# ip igmp snooping filter	181
3.10.10.6 (config-if)# ip igmp snooping immediate-leave	181
3.10.10.7 (config-if)# ip igmp snooping max-groups	182
3.10.10.8 (config-if)# ip igmp snooping mrouter	182
3.10.10.9 (config-if)# ip verify source	182
3.10.10.10 (config-if)# ip verify source limit	183
3.10.11 (config-if)# ipv6	183
3.10.11.1 (config-if)# ipv6 mld snooping filter	183
3.10.11.2 (config-if)# ipv6 mld snooping immediate-leave	183
3.10.11.3 (config-if)# ipv6 mld snooping max-groups <throttling>	184
3.10.11.4 (config-if)# ipv6 mld snooping mrouter	184
3.10.12 (config-if)# l2cp	184
3.10.13 (config-if)# lacp	185
3.10.13.1 (config-if)# lacp	185
3.10.13.2 (config-if)# lacp port-priority	185
3.10.13.3 (config-if)# lacp timeout	185
3.10.14 (config-if)# lldp	186
3.10.14.1 (config-if)# lldp cdp-aware	186
3.10.14.2 (config-if)# lldp med media-vlan policy-list	186
3.10.14.3 (config-if)# lldp med transmit-tlv	186
3.10.14.4 (config-if)# lldp receive	187
3.10.14.5 (config-if)# lldp tlv-select	187
3.10.14.6 (config-if)# lldp transmit	187
3.10.14.7 (config-if)# lldp trap	187
3.10.15 (config-if)# loop-protect	188
3.10.15.1 (config-if)# loop-protect	188
3.10.15.2 (config-if)# loop-protect action	188
3.10.15.3 (config-if)# loop-protect tx-mode	188
3.10.16 (config-if)# mac address-table learning	188
3.10.17 (config-if)# media-type	189
3.10.18 (config-if)# mtu	189
3.10.19 (config-if)# mvr	189
3.10.19.1 (config-if)# mvr immediate-leave	189
3.10.19.2 (config-if)# mvr name	190
3.10.19.3 (config-if)# mvr vlan	190
3.10.20 (config-if)# poe	191
3.10.20.1 (config-if)# poe lldp	191
3.10.20.2 (config-if)# poe mode	191
3.10.20.3 (config-if)# poe monitor	191
3.10.20.4 (config-if)# poe monitor { [host <host_name>] [interval <interval>] [retry <retry>] [action { no-action reboot power-off }] [waiting-time <waiting_time>] }*1	191
3.10.20.5 (config-if)# poe priority	192
3.10.20.6 (config-if)# poe schedule	192
3.10.20.7 (config-if)# poe schedule	192
3.10.21 (config-if)# port-security	193
3.10.21.1 (config-if)# port-security	193
3.10.21.2 (config-if)# port-security maximum	193
3.9.40.7 (config-if)# port-security maximum-violation	194
3.9.40.8 (config-if)# port-security violation	194
3.10.22 (config-if)# priority-flowcontrol prio	195
3.10.23 (config-if)# pvlan	195
3.10.23.1 (config-if)# pvlan	195
3.10.23.2 (config-if)# pvlan isolation	195
3.10.24 (config-if)# qos	196
3.10.24.1 (config-if)# qos class	196
3.10.24.2 (config-if)# qos cos	196
3.10.24.3 (config-if)# qos dei	196
3.10.24.4 (config-if)# qos dpl	197

3.10.24.1 (config-if)# qos dscp-classify.....	197
3.10.24.2 (config-if)# qos dscp-remark.....	197
3.10.24.3 (config-if)# qos dscp-translate.....	198
3.10.24.4 (config-if)# qos map cos-tag cos.....	198
3.10.24.5 (config-if)# qos map tag-cos pcp.....	198
3.10.24.6 (config-if)# qos pcp.....	199
3.10.24.7 (config-if)# qos policer.....	199
3.10.24.8 (config-if)# qos queue-policer queue.....	200
3.10.24.9 (config-if)# qos queue-shaper queue.....	200
3.10.24.10 (config-if)# qos shaper.....	200
3.10.24.11 (config)# qos storm.....	201
3.10.24.12 (config-if)# qos tag-remark.....	201
3.10.24.13 (config-if)# qos trust dscp.....	202
3.10.24.14 (config-if)# qos trust tag.....	202
3.10.24.15 (config-if)# qos wrr.....	202
3.10.25 (config-if)# rmon.....	203
3.10.25.1 (config-if)# rmon collection history.....	203
3.10.25.2 (config-if)# rmon collection stats.....	203
3.10.26 (config-if)# shutdown.....	203
3.10.27 (config-if)# spanning-tree.....	204
3.10.27.1 (config-if)# spanning-tree.....	204
3.10.27.2 (config-if)# spanning-tree auto-edge.....	204
3.10.27.3 (config-if)# spanning-tree bpdu-guard.....	204
3.10.27.4 (config-if)# spanning-tree edge.....	204
3.10.27.5 (config-if)# spanning-tree link-type.....	205
3.10.27.6 (config-if)# spanning-tree mst <instance> cost.....	205
3.10.27.7 (config-if)# spanning-tree mst <instance> port-priority.....	206
3.10.27.8 (config-if)# spanning-tree restricted-role.....	206
3.10.27.9 (config-if)# spanning-tree restricted-tcn.....	206
3.10.28 (config-if)# speed.....	206
3.10.29 (config-if)# switchport.....	207
3.10.29.1 (config-if)# switchport access vlan.....	207
3.10.29.2 (config-if)# switchport forbidden vlan.....	207
3.10.29.3 (config-if)# switchport hybrid acceptable-frame-type.....	207
3.10.29.4 (config-if)# switchport hybrid allowed vlan.....	208
3.10.29.5 (config-if)# switchport hybrid egress-tag.....	208
3.10.29.6 (config-if)# switchport hybrid ingress-filtering.....	209
3.10.29.7 (config-if)# switchport hybrid native vlan.....	209
3.10.29.8 (config-if)# switchport hybrid port-type.....	210
3.10.29.9 (config-if)# switchport mode.....	210
3.10.29.10 (config-if)# switchport trunk allowed vlan.....	211
3.10.29.11 (config-if)# switchport trunk native vlan.....	211
3.10.29.12 (config-if)# switchport trunk vlan tag native.....	212
3.10.29.13 (config-if)# switchport vlan ip-subnet id.....	212
3.10.29.14 (config-if)# switchport vlan mac.....	212
3.10.29.15 (config-if)# switchport vlan mapping.....	213
3.10.29.16 (config-if)# switchport vlan protocol group.....	213
3.10.30 (config-if)# vcl.....	213
3.11 COMMANDS IN CONFIG INTERFACE VLAN MODE.....	214
3.11.1 (config-if-vlan)# ip.....	214
3.11.1.1 (config-if-vlan)# ip address.....	214
3.11.1.2 (config-if-vlan)# ip dhcp server.....	214
3.11.1.3 (config-if-vlan)# ip igmp snooping.....	215
3.11.1.4 (config-if-vlan)# ip igmp snooping compatibility.....	215
3.11.1.5 (config-if-vlan)# ip igmp snooping last-member-query-interval.....	215
3.11.1.6 (config-if-vlan)# ip igmp snooping priority.....	215
3.11.1.7 (config-if-vlan)# ip igmp snooping querier address.....	216
3.11.1.8 (config-if-vlan)# ip igmp snooping querier election.....	216

3.11.1.9 (config-if-vlan)# ip igmp snooping query-interval	216
3.11.1.10 (config-if-vlan)# ip igmp snooping query-max-response-time	216
3.11.1.11 (config-if-vlan)# ip igmp snooping robustness-variable	217
3.11.1.12 (config-if-vlan)# ip igmp snooping unsolicited-report-interval.....	217
3.11.2 (config-if-vlan)# ipv6	217
3.11.2.1 (config-if-vlan)# ipv6 address	217
3.11.2.2 (config-if-vlan)# ipv6 address {autoconfig dhcp rapid-commit}.....	218
3.11.2.3 (config-if-vlan)# ipv6 mld snooping	218
3.11.2.4 (config-if-vlan)# ipv6 mld snooping compatibility	218
3.11.2.5 (config-if-vlan)# ipv6 mld snooping last-member-query-interval.....	219
3.11.2.6 (config-if-vlan)# ipv6 mld snooping priority <cos_priority>	219
3.11.2.7 (config-if-vlan)# ipv6 mld snooping querier election	219
3.11.2.8 (config-if-vlan)# ipv6 mld snooping query-interval <ipmc_qi>.....	219
3.11.2.9 (config-if-vlan)# ipv6 mld snooping query-max-response-time <ipmc_qri>.....	220
3.11.2.10 (config-if-vlan)# ipv6 mld snooping robustness-variable <ipmc_rv>.....	220
3.11.2.11 (config-if-vlan)# ipv6 mld snooping unsolicited-report-interval <ipmc_uri>.....	220
CHAPTER 4. WEB OPERATION & CONFIGURATION	221
4.1 INTRODUCTION	221
4.1.1 Login.....	221
4.1.2 Port Status	222
4.1.3 Refresh	222
4.1.4 Help System	222
4.1.5 Logout	222
4.2 SYSTEM.....	223
4.2.1 System Configuration.....	223
4.2.2 System Information	224
4.2.3 System IP.....	224
4.2.4 System IP Status.....	227
4.2.5 System NTP	227
4.2.6 System Time.....	228
4.2.7 System Log Configuration	229
4.2.8 System Log Information	230
4.2.9 System Detailed Log.....	231
4.2.10 System CPU Load	231
4.2.11 Alarm Relay	232
4.3 GREEN ETHERNET	233
4.3.1 Green Ethernet LED	233
4.3.2 Green Ethernet Configuration	234
4.3.3 Green Ethernet Status	235
4.4 PORTS	235
4.4.1 Ports Configuration.....	236
4.4.2 Ports State	238
4.4.3 Ports Traffic Overview	238
4.5 SECURITY.....	239
4.5.1 Switch	239
4.5.1.1 Users.....	239
4.5.1.2 Privilege Levels	240
4.5.1.3 Auth Method	242
4.5.1.4 SSH.....	243
4.5.1.5 HTTPS	244
4.5.2 Access Management.....	245
4.5.2.1 Access Management Configuration.....	245
4.5.2.2 Access Management Statistics	246
4.5.2.3 SNMP	246
4.5.2.3.1 SNMP System Configuration	246
4.5.2.3.2 Trap Configuration	247
4.5.2.3.2.1 Trap Destinations.....	247

4.5.2.3.2.2 Sources	248
4.5.2.3.3 SNMPv3 Community Configuration	249
4.5.2.3.4 SNMPv3 User Configuration	249
4.5.2.3.5 SNMPv3 Group Configuration	250
4.5.2.3.6 SNMPv3 View Configuration	251
4.5.2.3.7 SNMPv3 Access Configuration	251
4.5.2.4 RMON	252
4.5.2.4.1 RMON Statistics Configuration	252
4.5.2.4.2 RMON History Configuration	252
4.5.2.4.3 RMON Alarm Configuration	253
4.5.2.4.4 RMON Event Configuration	254
4.5.2.4.5 RMON Statistics Overview	255
4.5.2.4.6 History Overview	256
4.5.2.4.7 Alarm Overview	257
4.5.2.4.8 Event Overview	257
4.5.3 Network	258
4.5.3.1 Port Security	258
4.5.3.1.1 Configuration	258
4.5.3.1.2 Static and Sticky MAC Addresses	259
4.5.3.1.3 Switch Status	260
4.5.3.1.4 Details	261
4.5.3.2 NAS	261
4.5.3.2.1 Configuration	262
4.5.3.2.2 Switch Status	265
4.5.3.2.3 Port Statistics	266
4.5.3.3 ACL	267
4.5.3.3.1 Ports	267
4.5.3.3.2 Rate Limiters	268
4.5.3.3.3 Access Control List	268
4.5.3.3.4 ACL Status	272
4.5.3.4 DHCPv4	273
4.5.3.4.1 Server	273
4.5.3.4.1.1 DHCP Server Statistics	273
4.5.3.4.1.2 DHCP Server Binding IP	274
4.5.3.4.1.3 DHCP Server Declined IP	274
4.5.3.4.1.4 DHCP Server Mode Configuration	275
4.5.3.4.1.5 DHCP Server Excluded IP Configuration	275
4.5.3.4.1.6 DHCP Server Pool Configuration	276
4.5.3.4.2 Snooping Configuration	278
4.5.3.4.3 Snooping Table	278
4.5.3.4.4 DHCP Relay Configuration	279
4.5.3.4.5 Relay Statistics	280
4.5.3.4.6 Detailed Statistics	281
4.5.3.5 DHCPv6	282
4.5.3.5.1 Snooping Configurations	282
4.5.3.5.2 Dynamic (Snooping) Table	283
4.5.3.5.3 Statistics	283
4.5.3.5.4 Relay Configuration	284
4.5.3.5.5 Status & Statistics	284
4.5.3.6 IP Source Guard	285
4.5.3.6.1 Configuration	285
4.5.3.6.2 Static Table	286
4.5.3.6.3 Dynamic Table	286
4.5.3.7 IPv6 Source Guard	287
4.5.3.7.1 Source Guard Configuration	287
4.5.3.7.2 Static Table	288
4.5.3.7.3 Dynamic Table	288
4.5.3.8 ARP Inspection	289

4.5.3.8.1 Port Configuration	289
4.5.3.8.2 VLAN Configuration	290
4.5.3.8.3 Static Table	290
4.5.3.8.4 Dynamic Table Configuration	291
4.5.3.8.5 Dynamic Table Status	291
4.5.4 AAA	292
4.5.4.1 Radius Server Configuration	292
4.5.4.2 RADIUS Overview	293
4.5.4.3 RADIUS Details	294
4.5.4.4 TACACS+	296
4.6 AGGREGATION	297
4.6.1 Common	297
4.6.2 Groups	298
4.6.3 Aggregation Status	298
4.6.4 LACP	299
4.6.4.1 Port Configuration	299
4.6.4.2 System Status	300
4.6.4.3 Internal Status	300
4.6.4.4 Neighbor Status	301
4.6.4.5 Port Statistics	302
4.7 REDUNDANCY	303
4.7.1 Loop Protection	303
4.7.1.1 Configuration	303
4.7.1.2 Status	304
4.7.2 Spanning Tree	305
4.7.2.1 Bridge Settings	306
4.7.2.2 MSTI Mapping	307
4.7.2.3 MSTI Priorities	308
4.7.2.4 CIST Ports	309
4.7.2.5 MSTI Ports	310
4.7.2.6 Bridge Status	311
4.7.2.7 Port Status	313
4.7.2.8 Port Statistics	313
4.7.3 u-Ring	314
4.7.3.1 Configuration	314
4.7.3.2 Status	316
4.7.3.3 Details	317
4.7.4 CFM	319
4.7.4.1 Global	319
4.7.4.2 Domain	320
4.7.4.3 Service	321
4.7.4.4 MEP	323
4.7.4.5 Status	324
4.8 ERPS	325
4.8.1 Configuration	326
4.8.2 Status	327
4.9 IPMC PROFILE	328
4.9.1 Profile Table	328
4.9.2 Address Entry	330
4.10 MVR	330
4.10.1 Configuration	330
4.10.2 MVR Statistics	332
4.10.3 MVR Channel Groups	333
4.10.4 MVR SFM Information	333
4.11 IPMC	333
4.11.1 IGMP Snooping	334
4.11.1.1 Basic Configuration	335
4.11.1.2 VLAN Configuration	336

4.11.1.3 Status.....	337
4.11.1.4 Groups Information.....	338
4.11.1.1 Port Filtering Profile.....	338
4.11.1.2 IPv4 SFM Information.....	339
4.11.2 MLD Snooping.....	339
4.11.2.1 Basic Configuration.....	339
4.11.2.2 VLAN Configuration.....	341
4.11.2.3 Port Filtering Profile.....	342
4.11.2.4 Status.....	343
4.11.2.5 Groups Information.....	344
4.11.2.6 IPv6 SFM Information.....	344
4.12 LLDP.....	345
4.12.1 Configuration.....	345
4.12.2 Neighbours.....	346
4.12.3 LLDP-MED.....	347
4.12.4 LLDP-MED Neighbours.....	350
4.12.5 PoE.....	350
4.12.6 LLDP EEE.....	351
4.12.7 LLDP Global Counters.....	352
4.13 PoE (FOR POE MODELS ONLY).....	353
4.13.1 PoE Configuration.....	354
4.13.2 PD Monitor.....	355
4.13.3 PoE Schedule.....	356
4.13.4 Status.....	357
4.14 MAC TABLE.....	358
4.14.1 MAC Address Table Configuration.....	358
4.14.2 MAC Address Table.....	359
4.15 VLAN TRANSLATION.....	360
4.15.1 Port to Group Mapping.....	360
4.15.2 VID Translation Mapping.....	361
4.16 VLANs.....	361
4.16.1 Configuration.....	362
4.16.2 SVL.....	364
4.16.3 Membership.....	365
4.16.4 Ports.....	365
4.17 PRIVATE VLANs.....	366
4.17.1 PVLAN Membership.....	366
4.17.2 Port Isolation.....	367
4.18 GVRP.....	367
4.18.1 Global Configuration.....	367
4.18.2 Port Configuration.....	368
4.19 VCL.....	368
4.19.1 MAC-based.....	369
4.19.1.1 Membership Configuration.....	369
4.19.1.2 Membership Status.....	369
4.19.2 Protocol-based VLAN.....	370
4.19.2.1 Protocol to Group.....	370
4.19.2.2 Group to VLAN.....	371
4.19.3 IP Subnet-based VLAN.....	371
4.20 QoS.....	372
4.20.1 Port Classification.....	373
4.20.2 Port Policing.....	374
4.20.3 QoS Statistics.....	375
4.20.4 Queue Policing.....	375
4.20.5 Port Scheduler.....	376
4.20.6 Port Shaping.....	379
4.20.7 Port Tag Remarking.....	379
4.20.8 Port DSCP.....	381

4.20.9 DSCP-Based QoS	382
4.20.10 DSCP Translation.....	383
4.20.11 DSCP Classification	383
4.20.12 Ingress Map Configuration	384
4.20.13 Egress Map Configuration.....	385
4.20.14 QoS Control List	387
4.20.15 Storm Policing	390
4.20.16 QCL Status	391
4.20.17 Detailed Statistics	393
4.21 MIRRORING	395
4.22 UPNP	397
4.23 DDMI	397
4.23.1 Configuration	397
4.23.2 Overview	398
4.23.3 Detailed	398
4.24 L2CP	399
4.25 DIAGNOSTICS.....	400
4.25.1 Ping (IPv4)	400
4.25.2 Ping (IPv6)	401
4.25.3 Traceroute (IPv4)	402
4.25.4 Traceroute (IPv6)	403
4.25.5 VeriPHY	404
4.26 MAINTENANCE.....	405
4.26.1 Restart Device	405
4.26.2 Factory Defaults	405
4.26.3 Software.....	405
4.26.3.1 Upload	405
4.26.3.2 Image Select	406
4.26.4 Configuration	406
4.26.4.1 Save startup-config.....	406
4.26.4.2 Download	406
4.26.4.3 Upload	407
4.26.4.4 Activate	407
4.26.4.5 Delete	407

CHAPTER 1. INTRODUCTION

1.1 Welcome

Welcome and thank you for purchasing this "Industrial Strength" product from CTC Union. We hope this product is everything you wanted and more. Our Product Managers and R&D team have placed a "quality first" motto in our development of this series of Ethernet switches with the desire of providing a highly stable and reliable product that will give years of trouble free operation. We are so sure of our product design, we offer an unconditional 5 years warrantee.

In this chapter we will introduce all of the various models available in this series. These models can be either wall mounted or DIN rail mounted. Chapter 2 will describe the panels and mounting installation methods. All the models in this series utilize almost identical management interfaces, whether using serial console and CLI (command line interface) commands, Telnet, SSH, HTTP (Web GUI) or SNMP (Simple Network Management Protocol). Chapter 3 will briefly introduce CLI and chapter 4 will detail all of the configuration settings by using an easy to point and click Web interface which can be accessed from any available web browser.

1.2 Product Description

IGS-1604XSM & IGS-1604XSM-16PH(E) models are managed industrial grade Gigabit Ethernet switches that provide stable and reliable Ethernet transmission. Housed in rugged DIN rail or wall mountable enclosures, these switches are designed for harsh environments, such as industrial networking and intelligent transportation systems (ITS) and are also suitable for many military and utility market applications where environmental conditions exceed commercial product specifications.

Throughout the rest of this section, each model in this series will be described in details. After reviewing this section, the naming system for the model names will become clearer. But very basically, this series is divided in both Gigabit Ethernet without PoE & Gigabit Ethernet with PoE models.

1.2.1 IGS-1604XSM

The **IGS-1604XSM** is an Industrial Gigabit Switch for commercial temperature range of -40°C to +60°C. There are 16 LAN ports (port 1~16) with RJ-45 connectors that support 100/1000M Ethernet. There are 4 fiber ports that support 100M/1G/2.5G/5G/10G speed and utilize SFP+ cages that support any industry standard Fast or Gigabit SFP+ module. The Ethernet switch is fully manageable; supporting most standard Layer 2 Ethernet configurable settings.

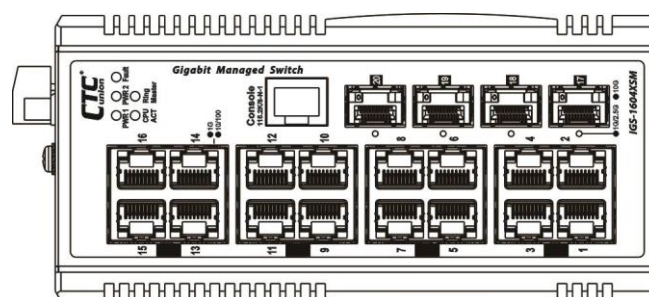

1.2.2 IGS-1604XSM-16PH(E)

The **IGS-1604XSM-16PH** is an Industrial Gigabit Ethernet, Power over Ethernet (PoE), Switch for temperature range of -40°C to +60°C. There are 16 LAN ports (port 1~16) with RJ-45 connectors that support 100M/1000m Ethernet. LAN ports 1~16 also support PoE for either IEEE802.3af (15.4 watts) or IEEE802.3at (30 watts) with a total power budget of 300W (30W per port).

There are 4 fiber ports that support 100M/1G/2.5G/5G/10G speed and utilize SFP cages that support any industry standard Fast or Gigabit SFP+ module. The Ethernet switch is fully manageable; supporting most standard Layer 2 Ethernet configurable settings.

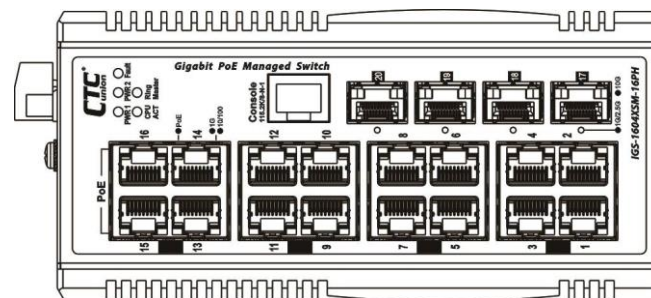

1.3 Product Features

- 16 x 10M/100M/1000M RJ-45 with 4 x 1G/2.5G/5G/10G SFP Fiber (IGS-1604XSM-16PH & IGS-1604XSM)
- Supports 16 x IEEE802.3af/802.3at PoE function (IGS-1604XSM-16PH)
- Supports operating temperature -40°C~60°C
- Supports 12/24/48VDC Redundant dual inputs (IGS-1604XSM)
- Supports 48VDC Redundant dual inputs (IGS-1604XSM-16PH)
- Support isolated RS-232 console port
- Normally Closed (NC) user programmable alarm relay contact
- IP30 rugged metal housing
- CE, FCC, Rail Traffic EN50121-4 Certified
- Industrial grade EMS (EN61000-6-2) and EMI (EN61000-6-4)
- Cable diagnostic, length measurement, cable OK or broken point distance
- Supports IEEE802.3az EEE (Energy Efficient Ethernet) Management to optimize power consumption
- STP, RSTP, MSTP, ITU-T G.8032 Ethernet Ring Protection Switching (ERPS) for cabling redundancy
- QoS, Traffic classification QoS, CoS, Band width control for Ingress and Egress, broadcast storm control, DiffServ
- IEEE802.1q VLAN, MAC based VLAN, IP subnet based VLAN, Protocol based VLAN, VLAN translation, MVR
- Dynamic IEEE 802.3ad LACP Link Aggregation, Static Link Aggregation
- IGMP/MLD snooping V1/V2/V3, IGMP Filtering / Throttling, IGMP query, IGMP proxy reporting, MLD snooping
- Security: Port based and MAC based IEEE802.1X, RADIUS, ACL, TACACS+, HTTP/HTTPS, SSL/SSH v2
- CLI, Web based management, SNMP v1/v2c/v3, Telnet server for management
- Software upgrade via TFTP and HTTP, dual partitioned flash for quick recovery from upgrade failure
- DHCP client/Relay/Snooping/Snooping option 82/Relay option 82
- RMON, MIB II, port mirroring, event syslog, DNS, NTP/SNTP, IEEE802.1ab LLDP
- Supports IPv6 Telnet server /ICMP v6, SNMP, HTTP, SSH/SSL, NTP/SNTP, TFTP, QoS, ACL

1.4 Product Specifications

Standards	IEEE 802.3	10Base-T 10Mbit/s Ethernet
	IEEE 802.3u	100Base-TX, 100Base-FX, Fast Ethernet
	IEEE 802.3ab	1000Base-T Gbit/s Ethernet over twisted pair
	IEEE 802.3z	1000Base-X Gbit/s Ethernet over Fiber-Optic
	IEEE 802.1d	STP (Spanning Tree Protocol)
	IEEE 802.1w	RSTP (Rapid Spanning Tree Protocol)
	IEEE 802.1s	MSTP (Multiple Spanning Tree Protocol)
	ITU-T G.8032 / Y.1344	ERPS (Ethernet Ring Protection Switching)
	IEEE 802.1Q	Virtual LANs (VLAN)
	IEEE 802.1X	Port based Network Access Control, Authentication
	IEEE 802.3ad	Link aggregation for parallel links with LACP
	IEEE 802.3x	Flow control for Full Duplex
	IEEE 802.1ad	Stacked VLANs, Q-in-Q
	IEEE 802.1p	LAN Layer 2 QoS/CoS Protocol for Traffic Prioritization
	IEEE 802.1ab	Link Layer Discovery Protocol (LLDP)
IEEE 802.3az	EEE (Energy Efficient Ethernet)	
Switch	VLAN Groups	up to 4096
	Switching Fabric	112Gbps
	Data Processing	Store and Forward
	Flow Control	IEEE 802.3x for full duplex mode, back pressure for half duplex mode
	MTU	10KBytes (Jumbo Frames)
	MAC Table	32K
	Memory Buffer	4M Bytes for packet buffer
	Device Memory	128M Bytes Flash ROM, 2G Bytes RAM
Connectors	LAN	16 x RJ-45 10/100/1000BaseT(X) Auto-detected speed, auto negotiation duplex, auto MDI/MDI-X function, Full/Half duplex
	Fiber	4 x 100M/1000M/2.5G/5G/10G speed mode SFP+ slots, supporting DDMI
	Console	RS-232 (RJ-45)
Ethernet	Network Cable	UTP/STP Cat.5e cable or above
	EIA/TIA-568	100-ohm (100m)
	Protocol	CSMA/CD
	Reverse polarity	Auto detect/correct
	Protection	Present
Overload current protection	Present	
Power	Power Supply	Redundant 12/24/48VDC (9.6~60VDC) Input power (IGS-1604XSM) Redundant 48VDC (46~57VDC) Input power (IGS-1604XSM-16PH)
	Power over Ethernet (IGS-1604XSM-16PH)	<ul style="list-style-type: none"> • 16 PoE enabled ports, End Span Alternate A Mode • Support IEEE802.3af 15.4watts PoE per port • Support IEEE802.3at 30watts PoE+ per port • (50~57V power input is recommended for IEEE802.3at PoE+ applications) • Total 300W power budget (maximum), 30W per port • Positive (V+) pins 1,2; Negative (V-) pins 3,6; Data 1, 2, 3, 6, 4, 5, 7, 8
Terminal Block	Power	Two redundant power inputs
	Alarm Contact	Relay output with current carrying capacity of 1A @24VDC
	Digital Inputs (DI)	One pair of DI connection

Certifications	EMC	CE
	EMI	FCC Part 15 sub B class A, CE EN55022 Class A
	Immunity & Emission for Heavy Industrial Environment	EN61000-6-2, EN61000-6-4
	EMS	EN61000-4-2 (ESD) Level 3, Criteria B EN61000-4-3 (RS) Level3, Criteria A EN61000-4-4 (Burst) Level3, Criteria A EN61000-4-5 (Surge) Level3, Criteria B EN61000-4-6 (CS) Level3, Criteria A EN61000-4-8 (PFMF, Magnetic Field) Field Strength: 300A/m, Criteria A
	Safety	EN62368-1
	Railway Traffic	EN50121-4
	Shock	EN60068-2-27
	Freefall	EN60068-2-32
	Vibration	EN60068-2-6

CHAPTER 2. PANELS & INSTALLATION

2.1 Views of Panels

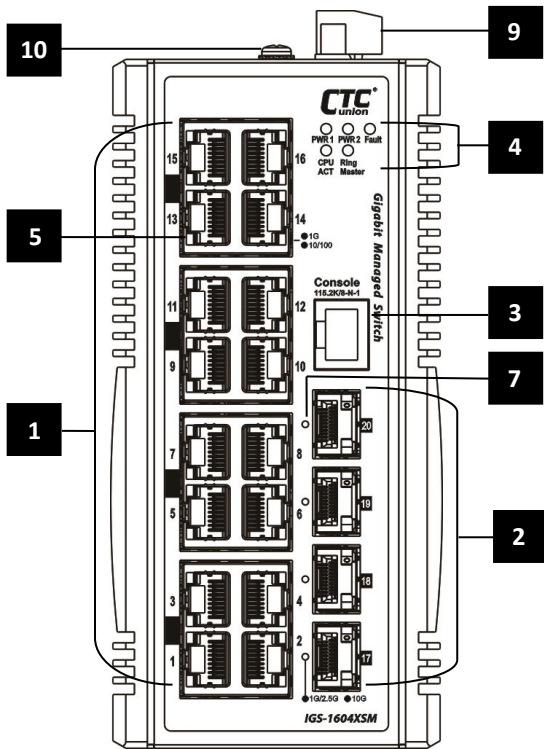

IGS-1604XSM Front Panel

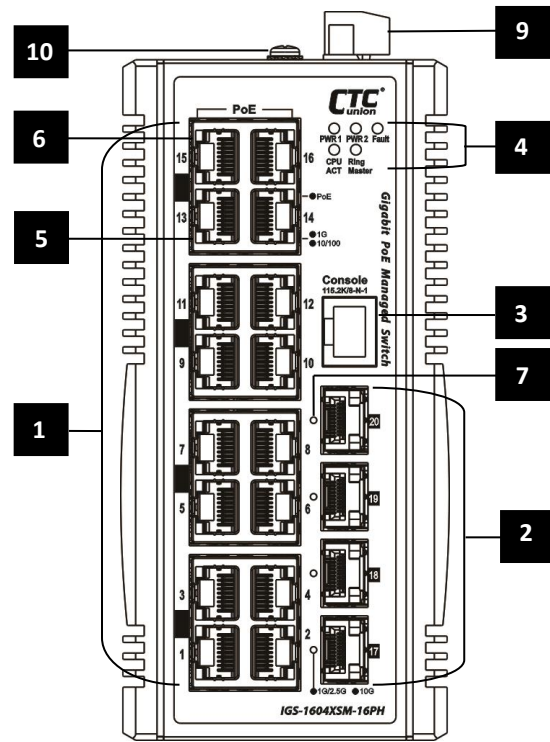

IGS-1604XSM-16PH Front Panel

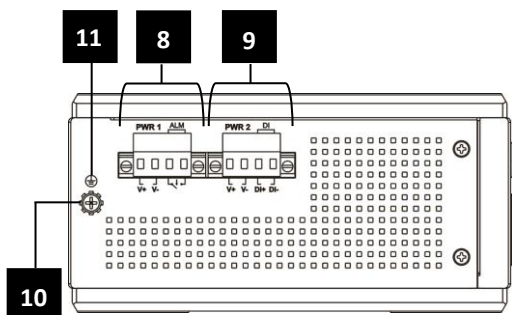

Top Panel

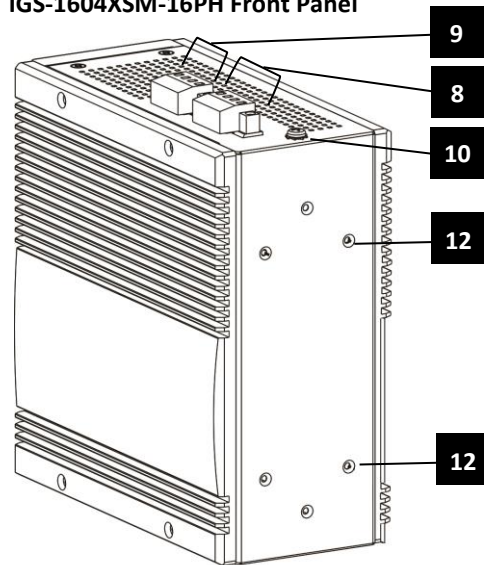

Side & Rear Panel

No.	Description	No.	Description
1	100M/1000M RJ-45 LAN ports	7	LED indicator for fiber optic SFP+ slot
2	1G/2.5G/5G/10G SFP+ slots	8	Terminal block for power 1 & alarm connection
3	Console port (RS-232 to RJ45)	9	Terminal block for power 2 & DI connection
4	Power, Fault, CPU ACT & Ring Master LED indicators	10	Earth grounding connection
5	Speed LED indicator for RJ-45 LAN port	11	Grounding sign
6	LED indicator for PoE function (For PoE models only)	12	DIN rail or wall mounting bracket holes

2.2 LAN Connections

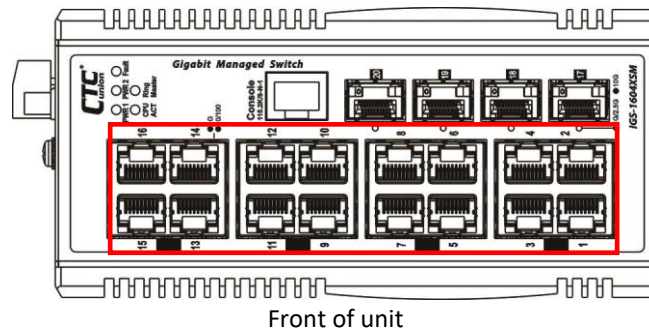

Front of unit

On the front panel, both IGS-1604XSM and IGS-1604XSM-16PH are equipped with 16 shielded 100M/1000M RJ-45 connectors that provide LAN connection to the Switch. For PoE model (IGS-1604XSM-16PH), port 1~16 also support PoE applications. Each of these LAN ports has associated LEDs which indicate the active link state, the detected speed of the interface and PoE status. A green indicates a link and a speed of 100M, while amber color indicates a link and speed of 1000M.

2.3 Fiber Connections

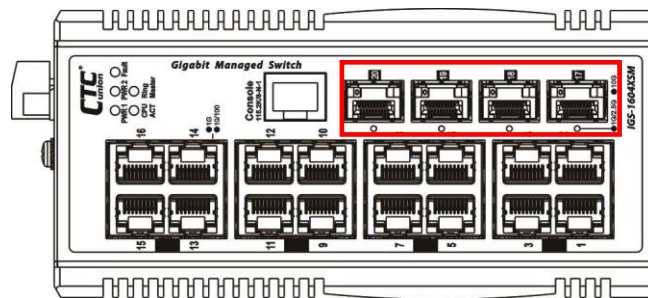

Front of unit

Both IGS-1604XSM and IGS-1604XSM-16PH utilize SFP+ modules for fiber transmissions. Each of the fiber ports has an associated status LED to indicate the presence or absence of fiber link and will also flash when there is Ethernet activity on the port. Each of three SFP cages may insert any standard SFP+ module and be configured for 100M, 1G, 2.5G, 5G or 10G operation. By having a third and fourth fiber port, these devices can be used in a ring or linear topology while still having a third port for a fiber branch. This makes these units extremely flexible when compared to other brand devices which have only two fiber ports.

Within the management interfaces, the fiber ports are numbered after the LAN ports. So, those fiber ports are seen as ports 17~20 by the internal switch and as viewed in management.

2.4 Console Port Connection

IGS-1604XSM & IGS-1604XSM-16PH have an asynchronous terminal console port for local management via a serial terminal. The terminal provides management via a CLI (Command Line Interface) which will be familiar to many networking engineers. For most users, the CLI can be used to initially configure TCP/IP access so that further configuration can be completed via the GUI (Graphical User Interface) and any web browser.

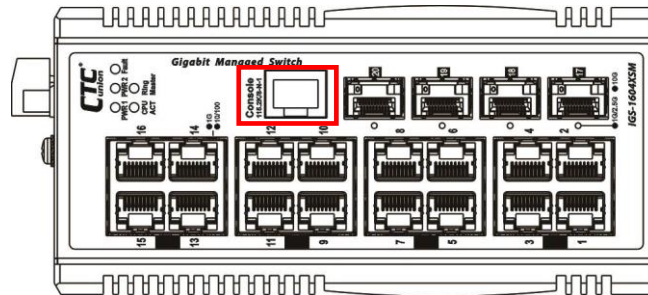

Front of Unit

2.4.1 RJ-45 Pin Assignment

This RJ-45 connector provides an RS-232 DCE (data communication equipment) asynchronous serial connection for local management.

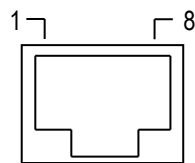

CONSOLE

to PC COM Port

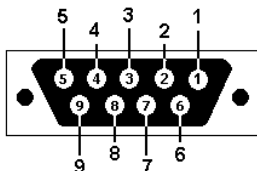

DB-9 (Female)		Direction	RJ-45	
Signal	Pin		Pin	Signal
RXD	2	←	3	TXD
TXD	3	→	6	RXD
GND	5	—	5	GND

2.5 Power Connection

A removable terminal block on the top panel provides power, alarm and DI connections. Power can be provided through the dual inputs from separate sources (PWR1 & PWR2). One power supply is enough to power up the device. If two power supplies are used, the device provides power redundancy function. See the figure provided below for recommended DC power wiring scheme.

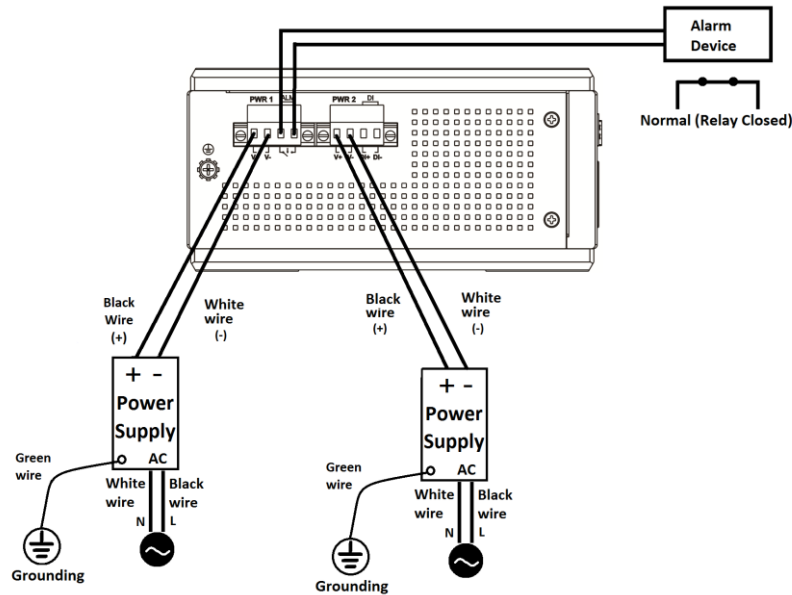

Recommended DC Power Wiring

2.6 Alarm Relay Connection

The alarm relay contact can be wired into an alarm circuit which senses an alarm condition when the contact is broken. The alarm relay is normally closed when there is no alarm condition. The alarm conditions are user programmable through management to include power, link faults or other fault conditions. Please note that the alarm relay contact can only support 1A current at 24VDC. Do not apply voltage and current that exceed these specifications.

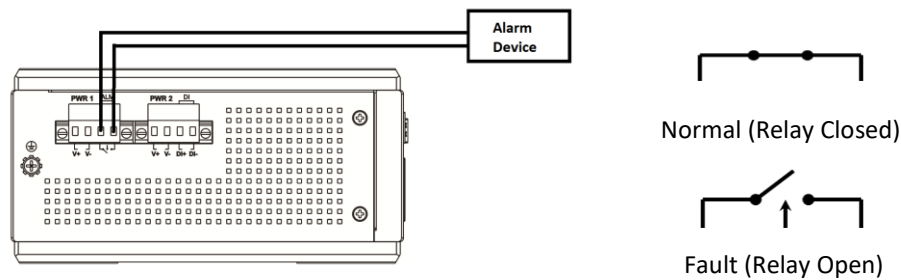

Alarm Relay Wiring

2.7 Digital Input (DI) Connection

This device provides two terminal blocks on the top panel. One terminal block is capable of connecting to power input 1 and alarm device (DO); and the other one is capable of connecting to power input 2 and digital input (DI) device. Normally, a digital input device is used to fire a trigger when the High (DI input is 17 to 30V) digital input or Low (DI input is 0 to 15V) digital input condition is detected. To decide which condition is able to trigger the follow-up events, users can set up actions triggered by digital input via web management.

The installation of DI trigger device is simple and can be done by inserting V+ and V- wire of your DI device to the corresponding pin contacts on the terminal block. Then use the appropriate flat screw to tighten retention screws on the terminal block to prevent wires from loosening.

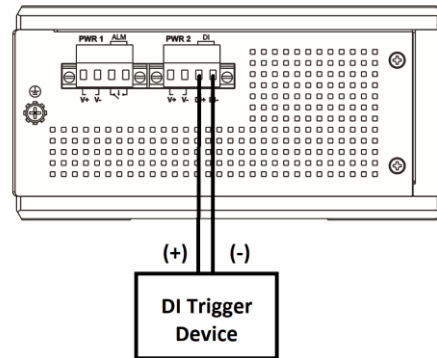

DI Trigger Device Wiring

2.8 Earth Ground Connection

A separate 'Earth' grounding terminal is provided on the top mental palate for safety grounding. It is highly recommended that a stable ground be attached to this device so that any surges on power or via LAN ports can be properly and safely shunted to ground. Follow steps below to install ground wire:

Step 1. Prepare one suitable ground screw and one ground cable.

Step 2. Attach the grounding screw to the ring terminal of the grounding cable. Make sure that the ground cable is long enough to reach the earth.

Step 3. Use a screwdriver (or other tools) to fasten the grounding screw on the earth ground hole securely.

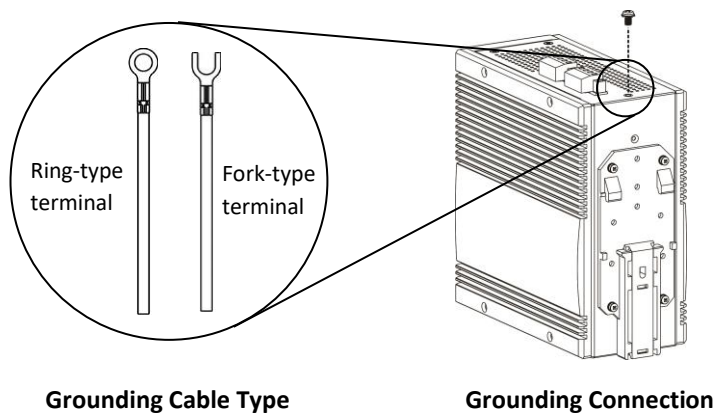

Grounding Cable Type

Grounding Connection

2.9 LED Indicators

LED	Color	Status	Definition
PWR 1 PWR 2	Green	On	Power is connected and active at the PWR1/PWR2 input terminal connection.
		Off	PWR1/PWR2 input terminal is not connected.
Fault	Amber	On	When one or more of the programmable alarm conditions is active.
		Off	No programmable alarm conditions are active.
CPU ACT	Green	On	During normal use, this green LED will be lit, indicating a healthy condition of the running CPU.
Ring Master	Yellow	On	Lit when this unit is the 'master' in a fiber ring and all units are configured for u-Ring or ERPS (Ethernet Ring Protection Switching or G.8032).
LAN 1~16 Link/Act	Green	On	Port link is up and works in 10M/100M.
		Blinking	Traffic is present.
	Amber (for IGS models)	On	Port link is up and works in 1000M.
		Blinking	Traffic is present.
Fiber 17~20 Link/Act	Green	On	The fiber link is up.
		Blinking	Traffic is present.
PoE (1~16)	Green (for IGS- 1604XSM- 16PH model)	On	The respective LAN port has successfully negotiated PoE and is supplying output power to the remote connected PD.
		Blinking	One of the PoE faults (overload, short circuit, port failure at startup) occurs.
		Off	PD is not connected or output power is not provided.

2.10 Installation

IGS-1604XSM & IGS-1604XSM-16PH are designed for wall mounting or DIN rail mounting. The units come with both wall mount and DIN rail hardware brackets from the factory.

2.10.1 Mounting

When installing the DIN rail bracket, be sure to correctly align the orientation pin.

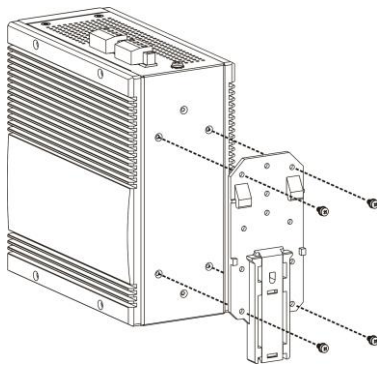

DIN Rail

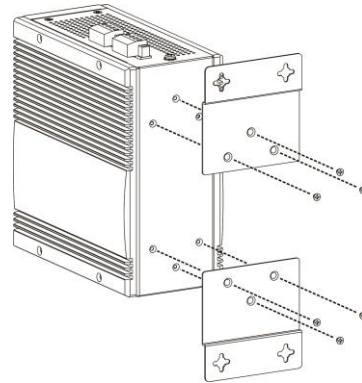

Wall Mount

2.10.2 Un-mounting

Both IGS-1604XSM and IGS-1604XSM-16PH device with DIN Rail bracket have a steel spring in the upper rail of the bracket. This spring is compressed for mounting and un-mounting by applying downward force.

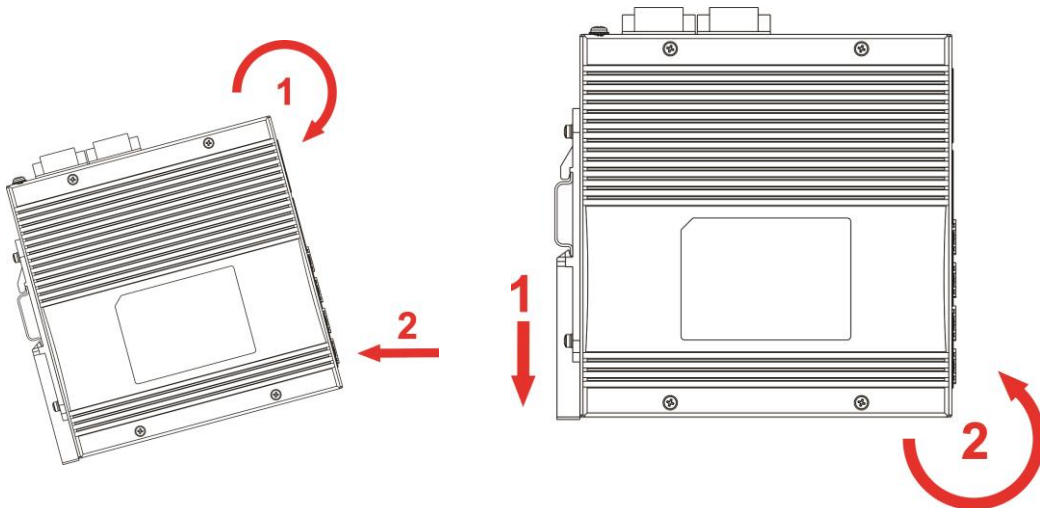

Mounting

Un-mounting

CHAPTER 3. INTRODUCTION TO CLI

3.1 General Introduction

The IGS Series of industrial Ethernet switches provide a number of configuration/management methods. The first and very basic is serial console access. This method is also called out-of-band management and is only available when a terminal or administrator PC can be physically connected to the local switch at the CONSOLE port using RJ45 to RS-232 console cable. Accessing the switch via CONSOLE port allows the user to use Command Line Interface (CLI) to manage and configure the device. The out-of-band management is relatively useful when you lose the network connection to the device.

The out-of-band management via console access, using a command line (CLI), is familiar to most network engineers. For engineers that are not comfortable using CLI, this device can also be managed using any standard Web Browser in a more user friendly 'point-and-click' method. Therefore, in most configuration scenarios, the console will only be used to initially configure the IP address, so that the device may be accessed via the other methods which require working TCP/IP.

After the device has been properly configured for the application and placed into service, a third method of configuration/management can be employed using Simple Network Management Protocol (SNMP). The operator will use SNMP management software to manage and monitor switches on a network. This requires some configuration of the device to allow SNMP management. In addition, the network management platform will need to import and compile the proprietary MIB (management information base) file so that the manager knows "how" to manage the IFS/IGS devices.

3.2 Access Connection

3.2.1 Telnet Operation

To use Command Line Interface (CLI), you can choose to access the device through a Telnet/ssh connection via TCP/IP network over Ethernet using any one of the RJ-45 ports. For initial operation, use the default TCP/IP settings (10.1.1.1) to login to the device. This device supports up to 16 simultaneous Telnet sessions. Each session will disconnect automatically after a period of idle time specified by exec-timeout command.

Default TCP/IP settings:

IP Address: 10.1.1.1
Subnet Mask: 255.255.255.0
Username: admin
Password: None (Leave this field blank)

3.2.2 CONSOLE Operation

Use the provided accessory cable to connect the "CONSOLE" port (RJ-45) to the PC terminal communications port (DB9). Run any terminal emulation program (HyperTerminal, PuTTY, TeraTerm Pro, etc.) and configure the communication parameters as follows:

Speed: 115,200
Data: 8 bits
Parity: None
Stop bits: 1
Flow control: None

From a cold start, the following screen will be displayed. At the "Username" prompt, enter 'admin' with no password.

```
Press ENTER to get started
Username: admin
Password:
```

3.3 CLI Modes

The Command Line Interface (CLI) is mainly divided into four basic modes; these are User mode, EXEC mode, Config mode and Config Interface mode. After entering the username and password, you start from the Exec mode (prompted with “#”). The commands available in User mode and EXEC mode are limited. For more advanced configurations, you must enter Config mode or Config Interface mode. In each mode, a question mark (?) at the system prompt can be issued to obtain a list of commands available for each command mode. The following table provides a brief overview of modes available in this device.

Mode	Prompt	Enter Method	Exit Method
User mode	>	enable	disable
EXEC mode	#	Enter authorized username and password	Exit, logout
Global Config Mode	(config)#	Enter “configure terminal” after “#”	End, exit, do logout
Config Interface Mode	(config-if)#	Specify interface, interface type and number after (config)#	End, exit, do logout

3.4 Quick Keys

There are several useful quick keys you can use when editing command lines.

Keyboard	Action
?	Issue “?” to get a list of commands available in the current mode.
Up arrow key	To view the previous entered commands.
Down arrow key	To view the previous entered commands.
Tab key	To complete an unfinished command.

3.5 Command Syntax

Commands introduced in this user manual are written using the coherent symbols and easy-to-understand syntax and style. Although users can issue Help command to complete a desired command in CLI, it is useful to understand frequently-used symbols and syntax conventions. The following table lists the syntax conventions used in this user manual together with an example.

Example: (config-if-vlan)# ip address { { <address> <netmask> } | { dhcp [fallback <fallback_address> <fallback_netmask> [timeout <fallback_timeout>]] } }

Symbol	Function	Example	Explanation
< > (Angle bracket)	Enter a value, alphanumeric strings or keywords.	<address> <netmask>	Enter IP address and subnet mask.
[] (Square bracket)	This is an optional parameter.	[fallback <fallback_address> <fallback_netmask> [timeout <fallback_timeout>]]	Fallback parameter is an optional item.
{ } (Curly bracket)	A curly bracket has the following two functions: 1. If there are more than two options available, a curly bracket can be used to separate them. 2. The outer curly bracket means that this is a must parameter. At least one value should be specified.	{ { <address> <netmask> } { dhcp [fallback <fallback_address> <fallback_netmask> [timeout <fallback_timeout>]] } }	At least specify one option to complete the command.
(Vertical bar)	Use a vertical bar to separate options.	{ { <address> <netmask> } { dhcp [fallback <fallback_address> <fallback_netmask> [timeout <fallback_timeout>]] } }	Enter IP address or use DHCP to assign IP address automatically.

3.6 Basic Configurations

This section introduces users how to change the default IP address to the desired one and save the current running configurations to startup configurations. For detailed introductions to commands, please see section 3.7, 3.8, 3.9, 3.10.

3.6.1 Configuring IPv4 Address

IP address: 192.168.0.101

Subnet mask: 255.255.255.0

```
# config terminal
(config)# interface vlan 1
(config-if-vlan)# ip address 192.168.0.101 255.255.255.0
(config-if-vlan)# exit
(config)# exit
# show ip interface brief
Vlan Address      Method  Status
-----
1 192.168.0.101/24 Manual  DOWN
```

3.6.2 Enter Config Interface Mode

- Enter Port 3's Config Interface mode.

```
# config terminal
(config)# interface FastEthernet 1/3
(config-if)#
```

NOTE: 1/3 means Ethernet Interface 1, Port 3.

- Enter Port 1~3's Config Interface mode.

```
# config terminal
(config)# interface FastEthernet 1/1-3
(config-if)#
```

NOTE: 1/1-3 means Ethernet Interface 1, Port 1 to Port 3.

- Enter Port 1~3 & Port 5's Config Interface mode.

```
# config terminal
(config)# interface FastEthernet 1/1-3,5
(config-if)#
```

NOTE: 1/1-3,5 means Ethernet Interface 1, Port 1 to Port 3 and Port 5.

3.6.3 Save Configurations

```
# copy running-config startup-config
Building configuration...
% Saving 1469 bytes to flash:startup-config
#
```

3.6.4 Restart the Device

```
# reload warm
% Warm reload in progress, please stand by.
#

Copyright (C) 2000, 2001, 2002, 2003, 2004, 2005, 2006, 2007, 2008, 2009
Free Software Foundation, Inc.
RedBoot is free software, covered by the eCos license, derived from the
GNU General Public License. You are welcome to change it and/or distribute
copies of it under certain conditions. Under the license terms, RedBoot's
source code and full license terms must have been made available to you.
Redboot comes with ABSOLUTELY NO WARRANTY.

RedBoot> fi lo -d managed
Image loaded from 0x80040000-0x80ae54cc
RedBoot> go

Press ENTER to get started
```

3.6.5 Load Factory Defaults

Load factory default settings

```
# reload defaults
% Reloading defaults, attempting to keep IP address. Please stand by.
```

Load factory defaults but keep IP settings

```
# reload defaults keep-ip
% Reloading defaults, attempting to keep IP address. Please stand by.
```

3.6.6 Show System and Software Information

```
# show version

MAC Address       : 00-02-ab-00-00-01
Serial Number     : Undefined
Previous Restart  : Cold

System Contact    :
System Name       :
System Location   :
System Time       : 2015-01-01T00:28:35+00:00
System Uptime     : 00:28:39

Bootloader
-----
Image             : UBoot
Version           : 2019.10
Date              : (Oct 20 2020 - 08:55:58 +0800)fireant

Primary Image
-----
Image             : Linux (Active)
Version           : 1.04
Date              : 2023-05-11T15:50:03+08:00

Backup Image
-----
Image             : linux.bk
Version           : 1.01
Date              : 2022-09-14T15:51:29+08:00

-----
SID : 1
-----

Flash Type        : NOR-only
Port Count        : 20
Product           : CTC Union I1604X-SERIES GigaBit Ethernet Switch
Software Version  : Ver 1.04
Build Date        : 2023-05-11T15:50:03+08:00
PoE Version       : HW Ver.:0, Prod:22, sw ver:218, param:19, build:4, internal sw ver:816, Asic Patch Num:20046
```

3.6.7 Show Running Configurations

```
# show running-config
Building configuration...
username admin privilege 15 password none
!
vlan 1
!
!
!
no smtp server
spanning-tree mst name 00-02-ab-00-00-01 revision 0
!
interface FastEthernet 1/1
no spanning-tree
!
interface FastEthernet 1/2
no spanning-tree
!
interface FastEthernet 1/3
no spanning-tree
!
interface FastEthernet 1/4
no spanning-tree
!
-- more --, next page: Space, continue: g, quit: ^C
```

3.6.8 Show History Commands

```
# show history
config t
exit
config t
ip arp ex
exit
```

```
> show history
config t
interface FastEthernet 1/3
exit
interface FastEthernet 1/1-5
exit
interface FastEthernet 1/1-3,5,7
flowcontrol on
exit
show interface * status
disable
show clock detail
show dot1x
show history
```

3.6.9 Help

Help command can be issued in User, Exec, and Global Config mode to get a hint message describing how to use “show” command to get help from CLI.

```
# help
Help may be requested at any point in a command by entering
a question mark '?'. If nothing matches, the help list will
be empty and you must backup until entering a '?' shows the
available options.
Two styles of help are provided:
1. Full help is available when you are ready to enter a
   command argument (e.g. 'show ?') and describes each possible
   argument.
2. Partial help is provided when an abbreviated argument is entered
   and you want to know what arguments match the input
   (e.g. 'show pr?').
```

3.6.10 Logout

To close an active terminal session, issue the “logout” command in User or EXEC mode.

```
(config)# exit
# logout

Press ENTER to get started
```

```
# disable
> logout

Press ENTER to get started
```

3.7 Commands in User Mode

When you successfully login in Command Line Interface, you are in Exec Mode (prompted with "#"). To enter User mode, issue "disable" command after # prompt. Then you will be directed to User mode with ">" prompt.

```
Username: admin
Password:
#
# disable
>
```

In User mode, only limited commands are available. These commands are used for clearing statistics, entering Exec mode and pinging the specified destination. To configure a function, you should enter Config mode or Config Interface mode.

3.7.1 > *clear ip acd*

Syntax: > clear ip acd

Explanation: Clear IPv4 address conflict detection (ACD) results.

3.7.2 > *clear ipv6 dhcp relay statistics*

Syntax: > clear ipv6 dhcp relay statistics [interface vlan <vlan_id> [interface vlan <rel_vlan_id>]]

Explanation: Clear IPv6 DHCP relay statistics.

3.7.3 > *enable*

Syntax: > enable [<new_priv>]

[<new_priv: 0-15>]: Choose a privilege level.

Explanation: Enter the Exec mode.

3.7.4 > *exit*

Syntax: > exit

Explanation: Return to the previous mode. Issuing this command in User mode will logout the Command Line Interface.

3.7.5 > help

Syntax: > help

Explanation: Provide help messages.

3.7.6 > logout

Syntax: > logout

Explanation: Logout the Command Line Interface.

3.7.7 > ping ip

Syntax: > ping ip { <domain_name> | <ip_addr> } [ttl <ttl_value>] [repeat <count>] [{ saddr <src_addr> | sif { <port_type> <src_if> | vlan <vlan_id> } }] [size <size>] [data <data_value>] [{ verbose | quiet }]

Parameters:

{ <domain_name> | <ip_addr> }: Specify IPv4 address or domain name that you want to ping.

[ttl <ttl_value>]: Specify the Time-To-Live (TTL) field value in the IPv4 header. The default value is 64. The valid range is 1-255.

[repeat <count>]: The number of packets that are sent to the destination IP or host.

[{ saddr <src_addr> | sif { <port_type> <src_if> | vlan <vlan_id> } }]: Specify source interface information for PING function.

saddr <src_addr>: This field can be used to force the test to use a specific local interface with the specified IP address as the source interface. The specified IP address must be configured on a local interface. Leave this field empty for automatic selection based on routing configuration. Note: You may only specify either the VID or the IP Address for the source interface.

sif { <port_type> <src_if>: This field can be used to force the test to use a specific local VLAN interface as the source interface. Leave this field empty for automatic selection based on routing configuration. Note: You may only specify either the VID or the IP Address for the source interface.

vlan <vlan_id>: This field can be used to force the test to use a specific local interface with the specified port number as the source interface. The specified port must be configured with a suitable IP address. Leave this field empty for automatic selection based on routing configuration. Note: You may only specify either the Source Port Number or the IP Address for the source interface.

[size <size>]: The size of the packet.

data <data_value>: Specify the pattern used in the ICMP data payload. The default value is 0. The valid range is 0-255.

{ verbose | quiet } : "quiet" option will not print the result of each ping request but will only show the final result.

Explanation: To carry out ping tests on the specified destination IPv4 address or host.

3.7.8 > ping ipv6

Syntax: > ping ipv6 { <domain_name> | <ip_addr> } [repeat <count>] [saddr <src_addr>] [sif { <port_type> <src_if> | vlan <vlan_id> }] [size <size>] [data <data_value>] [{ verbose | quiet }]

Parameters:

{ <domain_name> | <ip_addr> } : Specify IPv6 address or domain name that you want to ping.

[repeat <count>] : The number of packets that are sent to the destination IP or host.

saddr <src_addr> : This field can be used to force the test to use a specific local interface with the specified IP address as the source interface. The specified IP address must be configured on a local interface. Leave this field empty for automatic selection based on routing configuration. Note: You may only specify either the VID or the IP Address for the source interface.

[sif { <port_type> <src_if> | vlan <vlan_id> }] : Specify source interface information for PING function.

if { <port_type> <src_if> : This field can be used to force the test to use a specific local VLAN interface as the source interface. Leave this field empty for automatic selection based on routing configuration. Note: You may only specify either the VID or the IP Address for the source interface.

lan <vlan_id> : This field can be used to force the test to use a specific local interface with the specified port number as the source interface. The specified port must be configured with a suitable IP address. Leave this field empty for automatic selection based on routing configuration. Note: You may only specify either the source Port Number or the IP Address for the source interface.

[size <size>] : The size of the packet.

data <data_value> : Specify the pattern used in the ICMP data payload. The default value is 0. The valid range is 0-255.

{ verbose | quiet } : "quiet" option will not print the result of each ping request but will only show the final result.

Explanation: To carry out ping tests on the specified destination IPv6 address or host.

3.7.9 > traceroute ip

Syntax: > traceroute ip { <domain_name> | <ip_addr> } [dscp <dscp>] [timeout <timeout>] [{ saddr <src_addr> | sif { <port_type> <src_if> | vlan <vlan_id> } }] [probes <probes>] [firstttl <firstttl>] [maxttl <maxttl>] [icmp] [numeric]

Parameters:

{ <domain_name> | <ip_addr> } : The destination IP Address.

[`dscp <dscp>`]: This value is used for the DSCP value in the IPv4 header. The default value is 0. The valid range is 0-63.

[`probes <probes>`]: Determines the number of probes (packets) sent for each hop. The default value is 3. The valid range is 1-60.

[`timeout <timeout>`]: Determines the number of seconds to wait for a reply to a sent request. The default number is 3. The valid range is 1-86400.

[`firstttl <firstttl>`]: Determines the value of the Time-To-Live (TTL) field in the IPv4 header in the first packet sent. The default number is 1. The valid range is 1-30.

[`maxttl <maxttl>`]: Determines the maximum value of the Time-To-Live (TTL) field in the IPv4 header. If this value is reached before the specified remote host is reached the test stops. The default number is 30. The valid range is 1-255.

[{ `saddr <src_addr>` | `sif { <port_type> <src_if>` | `vlan <vlan_id>` } }]: Specify source interface information for traceroute function.

saddr <src_addr>: This field can be used to force the test to use a specific local interface with the specified IP address as the source interface. The specified IP address must be configured on a local interface. Leave this field empty for automatic selection based on routing configuration. Note: You may only specify either the VID or the IP Address for the source interface.

sif { <port_type> <src_if>: This field can be used to force the test to use a specific local VLAN interface as the source interface. Leave this field empty for automatic selection based on routing configuration. Note: You may only specify either the VID or the IP Address for the source interface.

vlan <vlan_id>: This field can be used to force the test to use a specific local interface with the specified port number as the source interface. The specified port must be configured with a suitable IP address. Leave this field empty for automatic selection based on routing configuration. Note: You may only specify either the Source Port Number or the IP Address for the source interface.

[`icmp`]: By default, the traceroute command will use UDP datagrams. Selecting this option forces it to use ICMP ECHO packets instead.

[`numeric`]: By default the traceroute command will print out hop information using a reverse DNS lookup for the acquired host IP addresses. This may slow down the display if the DNS information is not available. Selecting this option will prevent the reverse DNS lookup and force the traceroute command to print numeric IP addresses instead.

Explanation: This command allows you to perform a traceroute test over IPv4 towards a remote host. Traceroute is a diagnostic tool for displaying the route and measuring transit delays of packets across an IPv4 network.

3.7.10 > *traceroute ipv6*

Syntax: > traceroute ipv6 { <domain_name> | <ip_addr> } [dscp <dscp>] [timeout <timeout>] [saddr <src_addr>] [sif { <port_type> <src_if> | vlan <vlan_id> }] [probes <probes>] [maxttl <maxttl>] [numeric]

Parameters:

{ <domain_name> | <ip_addr> }: The destination IP Address.

[dscp <dscp>]: This value is used for the DSCP value in the IPv4 header. The default value is 0. The valid range is 0-63.

[probes <probes>]: Determines the number of probes (packets) sent for each hop. The default value is 3. The valid range is 1-60.

[timeout <timeout>]: Determines the number of seconds to wait for a reply to a sent request. The default number is 3. The valid range is 1-86400.

[maxttl <maxttl>]: Determines the maximum value of the Time-To-Live (TTL) field in the IPv4 header. If this value is reached before the specified remote host is reached the test stops. The default number is 30. The valid range is 1-255.

saddr <src_addr>: This field can be used to force the test to use a specific local interface with the specified IP address as the source interface. The specified IP address must be configured on a local interface. Leave this field empty for automatic selection based on routing configuration. Note: You may only specify either the VID or the IP Address for the source interface.

[sif { <port_type> <src_if> | vlan <vlan_id> }]: Specify source interface information for traceroute function.

sif { <port_type> <src_if>: This field can be used to force the test to use a specific local VLAN interface as the source interface. Leave this field empty for automatic selection based on routing configuration. Note: You may only specify either the VID or the IP Address for the source interface.

vlan <vlan_id>: This field can be used to force the test to use a specific local interface with the specified port number as the source interface. The specified port must be configured with a suitable IP address. Leave this field empty for automatic selection based on routing configuration. Note: You may only specify either the Source Port Number or the IP Address for the source interface.

[numeric]: By default the traceroute command will print out hop information using a reverse DNS lookup for the acquired host ip addresses. This may slow down the display if the DNS information is not available. Selecting this option will prevent the reverse DNS lookup and force the traceroute command to print numeric IP addresses instead.

Explanation: This command allows you to perform a traceroute test over IPv6 towards a remote host. Traceroute is a diagnostic tool for displaying the route and measuring transit delays of packets across an IPv4 network.

3.7.11 show commands

In User mode, “show” commands can be issued to display current status or settings of a certain command. They will be introduced in Section 3.9 & 3.10.

3.8 Commands in EXEC Mode

3.8.1 # alarm suppress <alarm_name>

Syntax: # alarm suppress <alarm_name>

Explanation: Protect the device from a certain alarm flood.

3.8.2 # clear

3.8.2.1 # clear access management statistics

Syntax: # clear access management statistics

Explanation: Clear access (HTTP, HTTPS, SNMP, Telnet, SSH) management statistics.

3.8.2.2 # clear access-list ace statistics

Syntax: # clear access-list ace statistics

Explanation: Clear access list entry statistics.

3.8.2.3 clear cfm meps [domain <md_name>] [service <ma_name>] [mep-id <mepid>] statistics

Syntax: # clear cfm meps [domain <md_name>] [service <ma_name>] [mep-id <mepid>] statistics

Parameter:

[domain <md_name>] [service <ma_name>] [mep-id <mepid>]: Specify CFM MEP domain name, service name and MEP ID that you want to clear.

Explanation: Clear the specified CFM MEP statistics.

3.8.2.4 # clear dot1x statistics

Syntax: # clear dot1x statistics [interface (<port_type> [<v_port_type_list>])]

Parameter:

[interface (<* | FastEthernet | GigabitEthernet> [<v_port_type_list>])]: Specify the interface that you want to clear.

Explanation: Clear (the specified interfaces’) dot1x statistics.

3.8.2.5 # clear erps

Syntax: # clear erps [<groups>] statistics

Parameter:

[<groups>]: Specify the ERPS group that you want to clear.

Explanation: Clear (the specified group's) ERPS statistics.

3.8.2.6 # clear ip acd

Syntax: # clear ip acd

Explanation: Clear IPv4 address conflict detection (ACD) results.

3.8.2.7 # clear ip arp

Syntax: # clear ip arp

Explanation: Clear ARP cache.

3.8.2.8 # clear ip dhcp detailed statistics

Syntax: # clear ip dhcp detailed statistics { server | client | snooping | relay | helper | all } [interface (<port_type> [<in_port_list>])]

Explanation: Clear IP DHCP statistics.

Parameter:

{ server | client | snooping | relay | helper | all }: Specify the type of information that you want to clear.

[interface (<port_type> [<in_port_list>])]: Specify the interface type and port number.

3.8.2.9 # clear ip dhcp server binding <ip>

Syntax: # clear ip dhcp server binding <ip>

Parameter:

<ip>: Specify the IP address for this server binding setup.

Explanation: Clear DHCP server binding cache in relation to the specified IP address.

3.8.2.10 # clear ip dhcp server binding { automatic | manual | expired }

Syntax: # clear ip dhcp server binding { automatic | manual | expired }

Parameter:

{ automatic | manual | expired }: Specify the server binding mode.

Explanation: Clear automatic, manual or expired server binding caches.

3.8.2.11 # clear ip dhcp server statistics

Syntax: # clear ip dhcp server statistics

Explanation: Clear DHCP server statistics.

3.8.2.12 # clear ip dhcp snooping statistics

Syntax: # clear ip dhcp snooping statistics [interface (<port_type> [<in_port_list>])]

Explanation: Clear IP DHCP Snooping statistics.

3.8.2.13 # clear ip igmp snooping

Syntax: # clear ip igmp snooping [vlan <v_vlan_list>] statistics

Explanation: Clear IP IGMP Snooping statistics.

3.8.2.14 # clear ip statistics

Syntax: # clear ip statistics [system] [interface vlan <v_vlan_list>] [icmp] [icmp-msg <type>]

Explanation: Clear IPv4 statistics for system, interface and ICMP.

3.8.2.15 # clear ipv6 mld snooping

Syntax: # clear ipv6 mld snooping [vlan <v_vlan_list>] statistics

Explanation: Clear statistics for IPv6 MLD Snooping.

3.8.2.16 # clear ipv6 neighbors

Syntax: # clear ipv6 neighbors

Explanation: Clear the table for IPv6 neighbors.

3.8.2.17 # clear ipv6 statistics

Syntax: # clear ipv6 statistics [system] [interface vlan <v_vlan_list>] [icmp] [icmp-msg <type>]

Explanation: Clear IPv6 statistics for system, interface and ICMP.

3.8.2.18 # clear known-host-keys

Syntax: # clear known-host-keys

Explanation: Clear the cache of known hosts' SSH keys.

3.8.2.19 # clear lacp statistics

Syntax: # clear lacp statistics

Explanation: Clear LACP statistics.

3.8.2.20 # clear lldp statistics

Syntax: # clear lldp statistics

Explanation: Clear LLDP statistics.

3.8.2.21 # clear logging

Syntax: # clear logging [informational] [notice] [warning] [error]

Explanation: Clear specific syslog events.

3.8.2.22 # clear mac address-table

Syntax: # clear mac address-table

Explanation: Clear MAC address table.

3.8.2.23 # clear mvr

Syntax: # clear mvr [vlan <v_vlan_list> | name <mvr_name>] statistics

Explanation: Clear MVR statistics.

3.8.2.24 # clear port-security dynamic

Syntax: # clear port-security dynamic [{ address <mac> [vlan <vlan_on_mac>]}] { interface (<port_type> [<plist>]) [vlan <vlan_on_interface>] | vlan <vlan>}

Explanation: Clear port security information.

3.8.2.25 # clear spanning-tree

Syntax: # clear spanning-tree { { statistics [interface (<port_type> [<v_port_type_list>])] } | { detected-protocols [interface (<port_type> [<v_port_type_list_1>])] } }

Explanation: Clear specific interfaces' Spanning Tree statistics.

3.8.2.26 # clear statistics

Syntax: # clear statistics [interface] (<port_type> [<v_port_type_list>])

Explanation: Clear Fast Ethernet and/or Gigabit Ethernet interfaces' statistics.

3.8.2.27 # clear system led status

Syntax: # clear system led status [switch <switch_list>] {fatal | software | post | ztp | stack-firmware | all}

Explanation: Clear error status of system LED.

3.8.3 # config terminal

Syntax: # config terminal

Explanation: Enter the Global Config mode.

Example:

```
# config t
(config)#
```

3.8.4 # copy

Syntax: # copy { startup-config | running-config | <source_path> } { startup-config | running-config | <destination_path> } [syntax-check]

{ startup-config | running-config | <source_path> }: Specify the file type that you want to copy from. This can be "startup-config", "running-config" or a specific source file in flash or TFTP server.

{ startup-config | running-config | <destination_path> }: Specify the file type that you want to copy to. This can be "startup-config", "running-config" or a specific destination file in flash or TFTP server.

Explanation: Save running configurations to startup configurations.

```
# copy running-config startup-config
Building configuration...
% Saving 1596 bytes to flash:startup-config
#
```

Explanation: Save startup configurations to running configurations.

```
# copy startup-config running-config
Building configuration...
% Saving 1596 bytes to flash:startup-config
#
```

Explanation: Save running configurations to Flash 201

```
# copy running-config Flash:201
Building configuration...
% Saving 1487 bytes to flash:201
# dir
Directory of flash:
  r- 1970-01-01 00:00:00      284 default-config
  rw 2015-01-01 01:56:32    1487 startup-config
  rw 2015-01-01 01:56:49    1487 201
3 files, 3258 bytes total.
```

Explanation: Backup running configurations to the tftp server

```
# copy running-config tftp://10.1.1.223/newfile1
Building configuration...
% Saving 2168 bytes to TFTP server 10.1.1.223: /newfile1
#
```

Explanation: Restore the file in the tftp server to running configurations

```
# copy tftp://10.1.1.223/newfile1 running-config
% Loading /newfile1 from TFTP server 10.1.1.223
MEP instance is already created - must be deleted first
MEP instance is already created - must be deleted first
MEP instance is already created - must be deleted first
MEP instance is already created - must be deleted first
% ERPS group 1: Given protection group already created
% ERPS group 1: Group association failed
% ERPS group 1: Node is configured as neighbour for given group, can not set
as RPL
% ERPS group 2: Given protection group already created
% ERPS group 2: Group association failed
% ERPS group 2: Node is configured as neighbour for given group, can not set
as RPL
#
```

3.8.5 # delete

Syntax: # delete <path>

Explanation: Delete a file saved in Flash.

Parameters:

<Path : word>: Name of the file in Flash to be deleted.

Example: Delete a file named 201 in Flash.

```
# dir
Directory of flash:
  r- 1970-01-01 00:00:00      284 default-config
  rw 2015-01-01 01:56:32    1487 startup-config
  rw 2015-01-01 01:56:49    1487 201
3 files, 3258 bytes total.
# delete flash:201
# dir
Directory of flash:
  r- 1970-01-01 00:00:00      284 default-config
  rw 2015-01-01 01:56:32    1487 startup-config
2 files, 1771 bytes total.
```

3.8.6 # dir

Explanation: Display files in flash.

Example:

```
# dir
Directory of flash:
  r- 1970-01-01 00:00:00      284 default-config
  rw 2015-01-01 01:56:32    1487 startup-config
  rw 2015-01-01 01:56:49    1487 201
3 files, 3258 bytes total.
```

3.8.7 # disable & # enable

Explanation: Return to user mode or enter exec mode.

```
# disable
>
>
> enable
#
#
# enable 0
>
```

3.8.8 # dot1x

Syntax: # dot1x initialize [interface (<port_type> [<plist>])]

[interface (<port_type> [<plist>])]: Specify the type of interface that you intend to use. "*" means all interfaces.

<plist>: Specify the ports that apply to this command.

Explanation: To initialize dot1x function in an interface immediately.

3.8.9 # erps

Syntax: # erps <group> command {clear | force | manual} {port0 | port1}

Explanation: Configure ERPS instance.

Parameters:

<group: 1-64>: Specify a group number between 1~64.

{clear | force | manual}: Specify an action.

{port0 | port1}: Specify port0 (east) or port1 (west) that applies to this command.

3.8.10 # firmware

3.8.10.1 # firmware swap

Syntax: # firmware swap

Explanation: Use the other standby firmware image file uploaded to flash.

3.8.10.2 # firmware upgrade

Syntax: # firmware upgrade <TFTPServer_path_file : word>

<TFTPServer_path_file : word>: Specify the TFTP server IP address and firmware filename.

Explanation: Upgrade the firmware image.

Example: Upgrade the new firmware image.

```
# firmware upgrade 10.1.1.223 switchseries.dat
Downloaded "switchseries.dat", 4990102 bytes
Waiting for firmware update to complete
Starting flash update - do not power off device!
Erasing image...
Programming image...
... Erase from 0x40ff0000-0x40ffffff: .
... Program from 0x87fef000-0x87fff000 to 0x40ff0000: .
... Program from 0x87fef00a-0x87fef00c to 0x40ff000a: .
Flash update succeeded.
Rebooting system...
Copyright (C) 2000, 2001, 2002, 2003, 2004, 2005, 2006, 2007, 2008, 2009
Free Software Foundation, Inc.
RedBoot is free software, covered by the eCos license, derived from the
GNU General Public License. You are welcome to change it and/or distribute
copies of it under certain conditions. Under the license terms, RedBoot's
source code and full license terms must have been made available to you.
Redboot comes with ABSOLUTELY NO WARRANTY.
RedBoot> fi lo -d managed
Image loaded from 0x80040000-0x80be3e44
RedBoot> go

Press ENTER to get started>
```

3.8.11 # ip dhcp retry interface vlan

Syntax: # ip dhcp retry interface vlan <vlan_id>

<vlan_id>: Specify the valid VLAN ID for DHCP query.

Explanation: Restart the DHCP query process.

3.8.12 # more

Syntax: # more <path>

<path>: Specify the filename.

Explanation: Display file in Flash or in TFTP server.

3.8.13 # ping

3.8.13.1 # ping ip

Syntax: # ping ip { <domain_name> | <ip_addr> } [ttl <ttl_value>] [repeat <count>] [{ saddr <src_addr> | sif { <port_type> <src_if> | vlan <vlan_id> } }] [size <size>] [data <data_value>] [{ verbose | quiet }]

Explanation: To carry out ping tests on the specified destination IPv4 address or host.

Parameters:

{ <domain_name> | <ip_addr> }: Specify IPv4 address or domain name that you want to ping.

[ttl <ttl_value>]: Specify the Time-To-Live (TTL) field value in the IPv4 header. The default value is 64. The valid range is 1-255.

[repeat <count>]: The number of packets that are sent to the destination IP or host.

[{ saddr <src_addr> | sif { <port_type> <src_if> | vlan <vlan_id> } }]: Specify source interface information for PING function.

saddr <src_addr>: This field can be used to force the test to use a specific local interface with the specified IP address as the source interface. The specified IP address must be configured on a local interface. Leave this field empty for automatic selection based on routing configuration. Note: You may only specify either the VID or the IP Address for the source interface.

sif { <port_type> <src_if>: This field can be used to force the test to use a specific local VLAN interface as the source interface. Leave this field empty for automatic selection based on routing configuration. Note: You may only specify either the VID or the IP Address for the source interface.

vlan <vlan_id>: This field can be used to force the test to use a specific local interface with the specified port number as the source interface. The specified port must be configured with a suitable IP address. Leave this field empty for automatic selection based on routing configuration. Note: You may only specify either the Source Port Number or the IP Address for the source interface.

[size <size>]: The size of the packet.

data <data_value>: Specify the pattern used in the ICMP data payload. The default value is 0. The valid range is 0-255.

{ verbose | quiet } : "quiet" option will not print the result of each ping request but will only show the final result.

3.8.13.2 # ping ipv6

Syntax: # ping ipv6 { <domain_name> | <ip_addr> } [repeat <count>] [saddr <src_addr>] [sif { <port_type> <src_if> | vlan <vlan_id> }] [size <size>] [data <data_value>] [{ verbose | quiet }]

Explanation: To carry out ping tests on the specified destination IPv6 address or host.

Parameters:

{ <domain_name> | <ip_addr> }: Specify IPv6 address or domain name that you want to ping.

[repeat <count>]: The number of packets that are sent to the destination IP or host.

saddr <src_addr>: This field can be used to force the test to use a specific local interface with the specified IP address as the source interface. The specified IP address must be configured on a local interface. Leave this field empty for automatic selection based on routing configuration. Note: You may only specify either the VID or the IP Address for the source interface.

[sif { <port_type> <src_if> | vlan <vlan_id> } }]: Specify source interface information for PING function.

sif { <port_type> <src_if>: This field can be used to force the test to use a specific local VLAN interface as the source interface. Leave this field empty for automatic selection based on routing configuration. Note: You may only specify either the VID or the IP Address for the source interface.

vlan <vlan_id>: This field can be used to force the test to use a specific local interface with the specified port number as the source interface. The specified port must be configured with a suitable IP address. Leave this field empty for automatic selection based on routing configuration. Note: You may only specify either the Source Port Number or the IP Address for the source interface.

[size <size>]: The size of the packet.

data <data_value>: Specify the pattern used in the ICMP data payload. The default value is 0. The valid range is 0-255.

{ verbose | quiet }: "quiet" option will not print the result of each ping request but will only show the final result.

3.8.14 # reload

3.8.14.1 # reload cold

Syntax: # reload cold

Explanation: Perform a cold reload on the system.

3.8.14.2 # reload defaults

Syntax: # reload defaults [keep-ip]

Parameters:

[keep-ip]: Keep VLAN 1 IP setting.

Explanation: Restore the device to factory default settings.

3.8.15 # send

Syntax: # send { * | <session_list> | console 0 | vty <vty_list> } <message>

Explanation: Send messages to other tty lines.

Parameters:

{ * | <session_list> | console 0 | vty <vty_list> }: Choose one of the options.

* : Specify "*" to denote all tty users.

<session_list>: Specify a session number between 0 and 16.

console 0: This means primary terminal line.

<vty_list>: Send a message to a virtual terminal.

<message>: Enter a message in 128 characters that you want to send.

3.8.16 # terminal

3.8.16.1 # terminal editing

Syntax: # terminal editing

Explanation: Enable command line editing.

Show: > show terminal
show terminal

Negation: # no terminal editing

3.8.16.2 # terminal exec-timeout

Syntax: # terminal exec-timeout <0-1440> [<0-3600>]

Parameters:

<0-1440>: Specify the timeout value in minutes.

[<0-3600>]: Specify the timeout value in seconds.

Explanation: Set up terminal timeout value.

Show: > show terminal
show terminal

Negation: # no terminal exec-timeout

3.8.16.3 # terminal history size

Syntax: # terminal history size <0-32>

Parameters:

<0-32>: Specify the current history size. "0" means to disable.

Explanation: Set up terminal history size.

Show: > show terminal
show terminal

Negation: # no terminal history size

3.8.16.4 # terminal length

Syntax: # terminal length <0 or 3-512>

Parameters:

<0 or 3-512>: Specify the lines displayed on the screen. "0" means no pausing.

Explanation: Set up terminal length.

Show: > show terminal
show terminal

Negation: # no terminal length

3.8.16.5 # terminal width

Syntax: # terminal width <0 or 40-512>

Parameters:

<0 or 40-512>: Specify the width displayed on the screen. "0" means unlimited width.

Explanation: Set up terminal display width.

Show: > show terminal
show terminal

Negation: # no terminal width

3.8.17 traceroute

3.8.17.1 # traceroute ip

Syntax: # traceroute ip { <domain_name> | <ip_addr> } [dscp <dscp>] [timeout <timeout>] [{ saddr <src_addr> | sif { <port_type> <src_if> | vlan <vlan_id> } }] [probes <probes>] [firstttl <firstttl>] [maxttl <maxttl>] [icmp] [numeric]

Explanation: This command allows you to perform a traceroute test over IPv4 towards a remote host. Traceroute is a diagnostic tool for displaying the route and measuring transit delays of packets across an IPv4 network.

Parameters:

{ <domain_name> | <ip_addr> }: The destination IP Address.

[dscp <dscp>]: This value is used for the DSCP value in the IPv4 header. The default value is 0. The valid range is 0-63.

[probes <probes>]: Determines the number of probes (packets) sent for each hop. The default value is 3. The valid range is 1-60.

[timeout <timeout>]: Determines the number of seconds to wait for a reply to a sent request. The default number is 3. The valid range is 1-86400.

[firstttl <firstttl>]: Determines the value of the Time-To-Live (TTL) field in the IPv4 header in the first packet sent. The default number is 1. The valid range is 1-30.

[maxttl <maxttl>]: Determines the maximum value of the Time-To-Live (TTL) field in the IPv4 header. If this value is reached before the specified remote host is reached the test stops. The default number is 30. The valid range is 1-255.

saddr <src_addr>: This field can be used to force the test to use a specific local interface with the specified IP address as the source interface. The specified IP address must be configured on a local interface. Leave this field empty for automatic selection based on routing configuration. Note: You may only specify either the VID or the IP Address for the source interface.

[{ sif { <port_type> <src_if> | vlan <vlan_id> } }]: Specify source interface information for traceroute function.

sif { <port_type> <src_if>: This field can be used to force the test to use a specific local VLAN interface as the source interface. Leave this field empty for automatic selection based on routing configuration. Note: You may only specify either the VID or the IP Address for the source interface.

vlan <vlan_id>: This field can be used to force the test to use a specific local interface with the specified port number as the source interface. The specified port must be configured with a suitable IP address. Leave this field empty for automatic selection based on routing configuration. Note: You may only specify either the Source Port Number or the IP Address for the source interface.

[icmp]: By default, the traceroute command will use UDP datagrams. Selecting this option forces it to use ICMP ECHO packets instead.

[numeric]: By default the traceroute command will print out hop information using a reverse DNS lookup for the acquired host ip addresses. This may slow down the display if the DNS information is not available. Selecting this option will prevent the reverse DNS lookup and force the traceroute command to print numeric IP addresses instead.

3.8.17.2 # traceroute ipv6

Syntax: # traceroute ipv6 { <domain_name> | <ip_addr> } [dscp <dscp>] [timeout <timeout>] [saddr <src_addr>] [sif { <port_type> <src_if> | vlan <vlan_id> }] [probes <probes>] [maxttl <maxttl>] [numeric]

Explanation: This command allows you to perform a traceroute test over IPv6 towards a remote host. Traceroute is a diagnostic tool for displaying the route and measuring transit delays of packets across an IPv4 network.

Parameters:

{ <domain_name> | <ip_addr> } : The destination IP Address.

[dscp <dscp>]: This value is used for the DSCP value in the IPv4 header. The default value is 0. The valid range is 0-63.

[probes <probes>]: Determines the number of probes (packets) sent for each hop. The default value is 3. The valid range is 1-60.

[timeout <timeout>]: Determines the number of seconds to wait for a reply to a sent request. The default number is 3. The valid range is 1-86400.

[maxttl <maxttl>]: Determines the maximum value of the Time-To-Live (TTL) field in the IPv4 header. If this value is reached before the specified remote host is reached the test stops. The default number is 30. The valid range is 1-255.

saddr <src_addr>: This field can be used to force the test to use a specific local interface with the specified IP address as the source interface. The specified IP address must be configured on a local interface. Leave this field empty for automatic selection based on routing configuration. Note: You may only specify either the VID or the IP Address for the source interface.

[sif { <port_type> <src_if> | vlan <vlan_id> }]: Specify source interface information for traceroute function.

sif { <port_type> <src_if>: This field can be used to force the test to use a specific local VLAN interface as the source interface. Leave this field empty for automatic selection based on routing configuration. Note: You may only specify either the VID or the IP Address for the source interface.

vlan <vlan_id>: This field can be used to force the test to use a specific local interface with the specified port number as the source interface. The specified port must be configured with a suitable IP address. Leave this field empty for automatic selection based on routing configuration. Note: You may only specify either the Source Port Number or the IP Address for the source interface.

[numeric]: By default the traceroute command will print out hop information using a reverse DNS lookup for the acquired host ip addresses. This may slow down the display if the DNS information is not available. Selecting this option will prevent the reverse DNS lookup and force the traceroute command to print numeric IP addresses instead.

3.8.18 # veriphy

Syntax: # veriphy [{ interface (<port_type> [<v_port_type_list>]) }]

Explanation: Run VeriPHY™ Cable Diagnostics for 10/100 /1G copper port.

Parameters:

[interface (<port_type>[<v_port_type_list>])]: Specify the port type and port numbers that you want to run VeriPHY cable diagnostics.

3.8.19 # show interface (<port_type> [<v_port_type_list>]) utp-cable-diagnostic

Syntax: # show interface (<port_type> [<v_port_type_list>]) utp-cable-diagnostic

Explanation: Issuing this command will run the Diagnostics for 10/100 and 1G copper ports. This will take approximately 5 seconds per port. If all ports are selected, this can take approximately 15 seconds. When completed, the page refreshes automatically, and you can view the cable diagnostics results in the cable status table.

Parameters:

(<port_type> [<v_port_type_list>]): Specify the port type and port number that apply to this cable diagnostics test.

3.8.20 show commands

In Exec mode, “show” commands can be issued to display current status or settings of a certain command. They will be introduced in Section 3.9 “Commands in Config Mode”.

3.9 Commands in Config Mode

3.9.1 (config)# aaa

3.9.1.1 (config)# aaa accounting

Syntax: (config)# aaa accounting { console | telnet | ssh } tacacs { [commands <priv_lvl>] [exec] }

Explanation: Configure the command and exec (login) authentication method for the client.

Parameters:

{ console | telnet | ssh }: Specify one of the authentication clients.

{ [commands <priv_lvl>] [exec] }: Use the remote TACACS server for accounting. Enable the accounting of all commands with a privilege level. Valid level values are 0 to 15. Specify "exec" to enable exec (login) accounting.

Negation: (config)# no aaa accounting { console | telnet | ssh }

Show: # show aaa

3.9.1.2 (config)# aaa authentication login

Syntax: (config)# aaa authentication login { console | telnet | ssh | http } { { local | radius | tacacs } [{ local | radius | tacacs }] [{ local | radius | tacacs }] }

Explanation: Configure the authentication method for the client.

Parameters:

{ console | telnet | ssh | http }: Specify one of the authentication clients.

{ { local | radius | tacacs } [{ local | radius | tacacs }] [{ local | radius | tacacs }] }: Specify one of the authentication methods for the specified client. At least one method needs to be specified. Users can specify three methods at most.

local: Use the local user database on the switch for authentication.

radius: Use remote RADIUS server(s) for authentication.

tacacs: Use remote TACACS+ server(s) for authentication.

NOTE: Methods that involve remote servers will time out if the remote servers are offline. In this case the next method is tried. Each method is tried and continues until a method either approves or rejects a user. If a remote server is used for primary authentication it is recommended to configure secondary authentication as 'local'. This will enable the management client to login via the local user database if none of the configured authentication servers are alive.

Example: Set the Console client to use remote RADIUS server(s) for authentication.

```
# config t
(config)# aaa authentication login console radius
```

Negation: (config)# no aaa authentication login { console | telnet | ssh | http }

Show: # show aaa

3.9.1.3 (config)# aaa authorization

Syntax: (config)# aaa authorization { console | telnet | ssh } tacacs commands <priv_lvl> [config-commands]

Explanation: Use this command to limit the CLI commands available to a user.

Parameters:

{ console | telnet | ssh } : Specify one of the authentication clients that applies to this rule.

<priv_lvl> : Use the remote TACACS server for authorization. Authorize all commands with a privilege level. Valid level values are 0 to 15.

[config-commands] : Specify "config-commands" to authorize configuration commands.

Negation: (config)# no aaa authorization { console | telnet | ssh }

Show: # show aaa

3.9.2 (config)# access management

3.9.2.1 (config)# access management

Syntax: (config)# access management

Explanation: Enable the access management function. When enabled, then current web connection will be lost and can not be accessed.

Negation: (config)# no access management

3.9.2.2 (config)# access management<access_id>

Syntax: (config)# access management <access_id> <access_vid> <start_addr> [to <end_addr>] { [web] [snmp] [telnet] | all }

Explanation: Create an access management rule.

Parameters:

<access_id: 1-16>: Specify an ID for this access management entry.

<access_vid>: Indicates the VLAN ID for the access management entry.

<start_addr> [to <end_addr>]: Indicate the starting and ending IP address for the access management entry.

{ [web] [snmp] [telnet] | all }; Specify matched hosts can access the switch from which interface.

Example: Allow IP 192.168.0.1 to 192.168.0.10 to access the device via Web, SNMP and Telnet.

```
# config t
(config)# access management 1 1 192.168.0.1 to 192.168.0.10 all
```

Negation: (config)# no access management
(config)# no access management <access_id>

Show: # show access management [statistics | <access_id_list>]

Clear: # clear access management statistics

3.9.3 (config)# access-list

3.9.3.1 (config)# access-list ace

Syntax: (config)# access-list ace <Aceld : 1-512> [action {deny | filter | permit}] [dmac-type {any| broadcast | multicast | unicast }][frame-type {any| arp|etype|ipv4|ipv4-icmp|ipv4-tcp|ipv4-udp|ipv6|ipv6-icmp|ipv6-tcp|ipv6-udp}] [ingress {any | interface <PORT_TYPE> }] [logging] [mirror] [next { <Aceld : 1-512>|last}] [policy <PolicyId : 0-255>] [rate-limiter {<RateLimiterId : 1-16>|disable}] [redirect {disable| interface <PORT_TYPE>}] [shutdown] [tag {any|tagged|untagged}] [tag-priority {0-1| 0-3| 2-3| 4-5| 4-7| 6-7| <TagPriority : 0-7>|any}] [vid { <Vid : 1-4095>|any}]

Explanation: Configure an access control list.

Parameters:

<Aceld : 1-512>: Specify access control list ID that applies to this rule.

[action {deny | filter | permit}]: Specify the action that applies to this rule.

[dmac-type {any| broadcast | multicast | unicast }]: Specify destination MAC type that applies to this rule.

[frame-type {any| arp|etype|ipv4|ipv4-icmp|ipv4-tcp|ipv4-udp|ipv6|ipv6-icmp|ipv6-tcp|ipv6-udp}]: Specify the frame type that applies to this rule.

[ingress {any | interface <PORT_TYPE> }]: Specify the ingress port.

[logging]: Enable logging function.

[mirror]: Enable the function of mirroring frames to destination mirror port.

[next { <Aceld : 1-256>|last}]: Insert the current ACE ID before the next ACE ID or put the ACE ID to the last one.

[policy <PolicyId : 0-63>]: Specify the policy ID.

[rate-limiter {<RateLimiterId : 1-16>|disable}]: Specify the rate limit ID or disable this function.

[redirect {disable| interface <PORT_TYPE>}]: Redirect frames to a specific port or disable this function.

[shutdown]: Enable shutdown function.

[tag {any|tagged|untagged}]: Specify whether frames should be tagged or untagged.

[tag-priority {0-1| 0-3| 2-3| 4-5| 4-7| 6-7| <TagPriority : 0-7>|any}]: Specify the priority value.

[vid { <Vid : 1-4095>|any}]: Specify the VLAN ID.

Show: # show access-list [interface [(<port_type> [<v_port_type_list>)]] [rate-limiter [<rate_limiter_list>]] [ace statistics [<ace_list>]]

Show: # show access-list ace-status [static] [ring] [loop-protect] [dhcp] [dhcp6-snooping] [upnp] [arp-inspection] [cfm] [erps] [ipmc] [ip-source-guard] [ipv6-source-guard] [ip] [conflicts]

Negation: (config)# no access-list ace <ace_list>

Clear: # clear access-list ace statistics

3.9.3.2 (config)# access-list ace update

Syntax: (config)# access-list ace update <Acelid : 1-512> [action {deny | filter | permit}] [dmac-type {any| broadcast | multicast | unicast }] [frame-type {any| arp|etype|ipv4|ipv4-icmp|ipv4-tcp|ipv4-udp|ipv6|ipv6-icmp|ipv6-tcp|ipv6-udp}] [ingress {any | interface <PORT_TYPE> }] [logging] [mirror] [next { <Acelid : 1-256>|last}] [policy <PolicyId : 0-255>] [rate-limiter {<RateLimiterId : 1-16>|disable}] [redirect {disable| interface <PORT_TYPE>}] [shutdown] [tag {any|tagged|untagged}] [tag-priority {0-1| 0-3| 2-3| 4-5| 4-7| 6-7| <TagPriority : 0-7>|any}] [vid { <Vid : 1-4095>|any}]

Explanation: Update an access control list.

Parameters:

<Acelid : 1-256>: Specify access control list ID that applies to this rule.

[action {deny | filter | permit}]: Specify the action that applies to this rule.

[dmac-type {any| broadcast | multicast | unicast }]: Specify destination MAC type that applies to this rule.

[frame-type {any| arp|etype|ipv4|ipv4-icmp|ipv4-tcp|ipv4-udp|ipv6|ipv6-icmp|ipv6-tcp|ipv6-udp}]: Specify the frame type that applies to this rule.

[ingress {any | interface <PORT_TYPE> }]: Specify the ingress port.

[logging]: Enable logging function.

[mirror]: Enable the function of mirroring frames to destination mirror port.

[next { <Acelid : 1-256>|last}]: Insert the current ACE ID before the next ACE ID or put the ACE ID to the last one.

[policy <PolicyId : 0-63>]: Specify the policy ID.

[rate-limiter {<RateLimiterId : 1-16>|disable}]: Specify the rate limit ID or disable this function.

[redirect {disable| interface <PORT_TYPE>}]: Redirect frames to a specific port or disable this function.

[shutdown]: Enable shutdown function.

[tag {any|tagged|untagged}]: Specify whether frames should be tagged or untagged.

[tag-priority {0-1| 0-3| 2-3| 4-5| 4-7| 6-7| <TagPriority : 0-7>|any}]: Specify the priority value.

[vid { <Vid : 1-4095>|any}]: Specify the VLAN ID.

Show: # show access-list [interface [(<port_type> [<v_port_type_list>])]] [rate-limiter [<rate_limiter_list>]] [ace statistics [<ace_list>]]

Negation: (config)# no access-list ace <ace_list>

3.9.3.3 (config)# access-list rate-limiter

Syntax: (config)# access-list rate-limiter [<rate_limiter_list>] { pps <pps_rate> | 100pps <pps100_rate> | kpps <kpps_rate> | 100kbps <kpbs100_rate> }

Explanation: Configure rate limiter that applies to each rate limit ID.

Parameters:

[<rate_limiter_list>]: Specify the “rate limit ID”, “100kbps” or “pps” . The allowed rate limit ID range is from 1~16.

{ pps <pps_rate> | 100pps <pps100_rate> | kpps <kpps_rate> | 100kbps <kpbs100_rate> }: Specify the rate limit rate.

Show: # show access-list rate-limiter [<RateLimiterList : 1~16>]

3.9.4 (config)# aggregation mode

Syntax: (config)# aggregation mode { [smac] [dmac] [ip] [port] }

Explanation: Configure aggregation mode.

Parameters:

[smac]: All traffic from the same Source MAC address is output on the same link in a trunk.

[dmac]: All traffic with the same Destination MAC address is output on the same link in a trunk.

[ip]: All traffic with the same source and destination IP address is output on the same link in a trunk.

[port]: All traffic with the same source and destination TCP/UDP port number is output on the same link in a trunk.

Negation: (config)# no aggregation mode

Show: # show aggregation [mode]

3.9.5 (config)# banner

3.9.5.1 (config)# banner [motd] <banner>

Syntax: (config)# banner [motd] <banner>

Parameters:

[motd]: Type in the message of the day.

Explanation: Configure the message of the day.

Negation: (config)# no banner [motd]

3.9.5.2 (config)# banner exec <banner>

Syntax: (config)# banner exec <banner>

Explanation: Display the configured message when successfully entering Exec mode.

Negation: (config)# no banner exec

3.9.5.3 (config)# banner login <banner>

Syntax: (config)# banner login <banner>

Explanation: Display the configured message when prompted for login ID and password.

Negation: (config)# no banner login

3.9.6 (config)# cfm

3.9.6.1 (config)# cfm domain

Syntax: (config)# cfm domain <md_name>

Explanation: Specify a domain name for this CFM entry.

Parameters:

<md_name>: Specify a CFM domain name. After entering a CFM domain name, you will be directed to (config-cfm-dmn)# mode.

Negation: (config)# no banner [motd | login | exec]

3.9.6.1.1 (config-cfm-dmn)# format

Syntax: (config-cfm-dmn)# format { none | string <name> }

Explanation: Specify the MD name format.

Parameters:

{ none | string <name> }: Specify a CFM domain name. To mimic Y.1731 MEG IDs, use type None.

3.9.6.1.2 (config-cfm-dmn)# interface-status-tlv

Syntax: (config-cfm-dmn)# interface-status-tlv { disable | enable | defer }

Explanation: Include or exclude Interface Status TLV in CCMs generated by this Domain or let higher level determine (may be overridden in Service).

Parameters:

{ disable | enable | defer }: Specify one of the following options:

Disable: Do not include Interface Status TLVs.

Enable: Include Interface Status TLVs.

Defer: Let the global configuration decide if Interface Status TLVs shall be included (may be overridden in Service).

3.9.6.1.3 (config-cfm-dmn)# organization-specific-tlv

Syntax: (config-cfm-dmn)# organization-specific-tlv { disable | defer }

Explanation: Exclude Organization-Specific TLV in CCMs generated by this Domain or let higher level determine (may be overridden in Service).

Parameters:

{ disable | defer }: Specify one of the following options:

Disable: Do not include Organization-Specific TLVs.

Defer: Let the global configuration decide if Organization-Specific TLVs shall be included (may be overridden in service).

3.9.6.1.4 (config-cfm-dmn)# port-status-tlv

Syntax: (config-cfm-dmn)# port-status-tlv { disable | enable | defer }

Explanation: Include or exclude Port Status TLV in CCMs generated by this Service or let higher level determine.

Parameters:

{ disable | enable | defer }: Specify one of the following options:

Disable: Do not include Port Status TLVs.

Enable: Include Port Status TLVs.

Defer: Let the Domain configuration decide if Port Status TLVs shall be included.

3.9.6.1.5 (config-cfm-dmn)# port-status-tlv

Syntax: (config-cfm-dmn)# port-status-tlv { disable | enable | defer }

Explanation: Include or exclude Port Status TLV in CCMs generated by this Domain or let higher level determine (may be overridden in Service).

Parameters:

{ disable | enable | defer }: Specify one of the following options:

Disable: Do not include Port Status TLVs.

Enable: Include Port Status TLVs.

Defer: Let the global configuration decide if Port Status TLVs shall be included (may be overridden in Service).

3.9.6.1.6 (config-cfm-dmn)# sender-id-tlv

Syntax: (config-cfm-dmn)# sender-id-tlv { disable | chassis | management | chassis-management | defer }

Explanation: Default Sender ID TLV format to be used in CCMs generated by this Domain (may be overridden in service)

Parameters:

{ disable | chassis | management | chassis-management | defer }: Specify one of the following options:

Disable: Do not include Sender ID TLVs.

Chassis: Enable Sender ID TLV and send Chassis ID (MAC Address).

Management: Enable Sender ID TLV and send Management address (IPv4 Address).

ChassisManagement: Enable Sender ID TLV and send both Chassis ID (MAC Address) and Management Address (IPv4 Address).

Defer: Let the global configuration decide if Sender ID TLVs shall be included (may be overridden in service).

3.9.6.1.7 (config-cfm-dmn)# level

Syntax: (config-cfm-dmn)# level <level>

Explanation: Specify MD/MEG level of this domain. Valid values are restricted to 0 - 7.

Parameters:

<level>: Valid values are restricted to 0 - 7.

3.9.6.1.8 (config-cfm-dmn)# service

Syntax: (config-cfm-dmn)# service <ma_name>

Explanation: Specify name of service. After you enter the name, you will be directed to (config-cfm-svc)# mode

Parameters:

<ma_name>: The allowed value is a single word which begins with an alphabetic letter A-Z or a-z with length 1-15.

Negation: (config-cfm-dmn)# no service { <ma_name> | all }

3.9.6.1.8.1 (config-cfm-dmn-svc)# continuity-check interval

Syntax: (config-cfm-dmn-svc)# continuity-check interval { 3.3ms | 10ms | 100ms | 1s | 10s | 1min | 10min }

Explanation: The CCM rate of all MEPs bound to this Service.

Parameters:

{ 3.3ms | 10ms | 100ms | 1s | 10s | 1min | 10min }: Specify a CCM interval rate.

3.9.6.1.8.2 (config-cfm-dmn-svc)# format

Syntax: (config-cfm-dmn-svc)# format { string <format_string> | integer <format_integer> | primary-vid | icc <format_icc_string> | icc-cc }

Explanation: Specify the short Service name format. This decides how the value of the Name parameter will be interpreted. To mimic Y.1731 MEG IDs, create an MD instance with an empty name and use Y1731 ICC or Y1731 ICC CC. Possible values are: String, Two Octets, Y1731 ICC, Y1731 ICC CC

Parameters:

{ string <format_string> | integer <format_integer> | primary-vid | icc <format_icc_string> | icc-cc }: Specify a format item.

3.9.6.1.8.3 (config-cfm-dmn-svc)# interface-status-tlv

Syntax: (config-cfm-dmn-svc)# interface-status-tlv { disable | enable | defer }

Explanation: Include or exclude Interface Status TLV in CCMs generated by this Domain or let higher level determine (may be overridden in Service).

Parameters:

{ disable | enable | defer }: Specify one of the following options:

Disable: Do not include Interface Status TLVs.

Enable: Include Interface Status TLVs.

Defer: Let the global configuration decide if Interface Status TLVs shall be included (may be overridden in Service).

3.9.6.1.8.4 (config-cfm-dmn-svc)# organization-specific-tlv

Syntax: (config-cfm-dmn-svc)# organization-specific-tlv { disable | defer }

Explanation: Exclude Organization-Specific TLV in CCMs generated by this Service or let higher level determine.

Parameters:

{ disable | defer }: Specify one of the following options:

Disable: Do not include Organization-Specific TLVs.

Defer: Let the Domain configuration decide if Organization-Specific TLVs shall be included.

3.9.6.1.8.5 (config-cfm-dmn-svc)# port-status-tlv

Syntax: (config-cfm-dmn-svc)# port-status-tlv { disable | enable | defer }

Explanation: Include or exclude Port Status TLV in CCMs generated by this Service or let higher level determine.

Parameters:

{ disable | enable | defer }: Specify one of the following options:

Disable: Do not include Organization-Specific TLVs.

Enable: Include Organization-Specific TLVs.

Defer: Let the global configuration decide if Organization-Specific TLVs shall be included (may be overridden in service).

3.9.6.2 (config)# cfm interface-status-tlv

Syntax: (config)# cfm interface-status-tlv { disable | enable }

Explanation: Exclude or include Interface Status TLV in CCM PDUs.

Parameters:

{ disable | enable }; Exclude or include Interface Status TLV in CCM PDUs.

3.9.6.3 (config)# cfm organization-specific-tlv

Syntax: (config)# cfm organization-specific-tlv { disable | enable oui <oui> subtype <subtype> value <value> }

Explanation: Exclude or include Organization Specific TLV in CCM PDUs.

Parameters:

{ disable | enable oui <oui> subtype <subtype> value <value> }; Exclude or include Organization Specific TLV in CCM PDUs. When enabled, users have to specify OUI, Subtype and Value.

3.9.6.4 (config)# cfm port-status-tlv

Syntax: (config)# cfm port-status-tlv { disable | enable }

Explanation: Exclude or include Port Status TLV in CCM PDUs.

Parameters:

{ disable | enable }; Exclude or include Port Status TLV in CCM PDUs. When enabled, users have to specify OUI, Subtype and Value.

3.9.6.5 (config)# cfm sender-id-tlv

Syntax: (config)# cfm sender-id-tlv { disable | chassis | management | chassis-management }

Explanation: Specify whether to use Sender ID used in CCM PDUs generated by the switch

Parameters:

{ disable | chassis | management | chassis-management }; Choose whether and what to use as Sender ID TLVs in CCMs generated by this switch. Can be overridden by Domain and Service level configuration. Options included are None, Chassis, Manage, ChassisManage.

3.9.7 (config)# clock

3.9.7.1 (config)# clock summer-time <word16> date

Syntax: clock summer-time <word16> date [<start_month_var> <start_date_var> <start_year_var> <start_hour_var> <end_month_var> <end_date_var> <end_year_var> <end_hour_var> [<offset_var>]]

Explanation: Configure daylight saving time. This is used to set the clock forward or backward according to the configurations set for a defined Daylight Saving Time duration. “Recurring” command is used to repeat the configuration every year.

Parameters:

summer-time <word16>: Specify a description for this day-light setting.

date [<start_month_var> <start_date_var> <start_year_var> <start_hour_var> <end_month_var> <end_date_var> <end_year_var> <end_hour_var> [<offset_var>]]

<start_month_var:1-12>: Specify the starting month.

<start_date_var: 1-31>: Specify the starting day.

<start_year_var:2000-2097>: Specify the starting year.

<start_hour_var: hh:mm>: Specify the time to start.

<end_month_var:1-12>: Specify the ending month.

<end_date_var: 1-31>: Specify the ending day.

<end_year_var:2000-2097>: Specify the ending year.

<end_hour_var: hh:mm>: Specify the time to start.

[<offset_var: 1-1440>]: Specify the number of minutes to add during Daylight Saving Time. The allowed range is 1 to 1440.

Negation: (config)# no clock summer-time

Show: > show clock
> show clock detail
show clock
show clock detail

3.9.7.2 (config)# clock summer-time <word16> recurring

Syntax: (config)# clock summer-time <word16> recurring [<start_week_var> <start_day_var> <start_month_var> <start_hour_var> <end_week_var> <end_day_var> <end_month_var> <end_hour_var> [<offset_var>]]

Explanation: Configure daylight saving time. This is used to set the clock forward or backward according to the configurations set for a defined Daylight Saving Time duration. “Recurring” command is used to repeat the configuration every year.

Parameters:

summer-time <word16>: Specify a description for this day-light setting.

recurring [<start_week_var> <start_day_var> <start_month_var> <start_hour_var> <end_week_var>
<end_day_var> <end_month_var> <end_hour_var> [<offset_var>]]

<start_week_var:1-5>: Specify the starting week.

<start_day_var: 1-31>: Specify the starting day.

<start_month_var:1-12>: Specify the starting month.

<start_hour_var: hh:mm>: Specify the time to start.

<end_week_var:1-5>: Specify the ending week.

<end_day_var: 1-31>: Specify the ending day.

<end_month_var: 1-12>: Specify the ending month.

<end_hour_var: hh:mm>: Specify the time to end.

[<offset_var: 1-1440>]: Specify the number of minutes to add during Daylight Saving Time. The allowed range is 1 to 1440.

Negation: (config)# no clock summer-time

Show: # show clock
show clock detail

3.9.7.3 (config)# clock timezone

Syntax: (config)# clock timezone <word> <-23-23> [<0-59>]

Explanation: Configure a timezone used in the switch.

Parameters:

<word16>: Specify the name of the timezone.

<-23-23>: Hours offset from UTC.

[<0-59>]: Minutes offset from UTC.

Negation: (config)# no clock timezone

Show: # show clock
show clock detail

3.9.8 (config)# ddmi

Syntax: (config)# ddmi

Explanation: To enable DDMI function. When enabled, users can view DDMI information of the inserted transceivers.

Negation: (config)# no ddmi

Show: # show ddmi

3.9.9 (config)# default access-list rate-limiter

Syntax: (config)# default access-list rate-limiter [<rate_limiter_list>]

Explanation: To default the specified rate-limiter ID.

Parameters:

[<rate_limiter_list: 1-16>]: Specify a rate limiter ID.

Example: To default rate-limiter 1.

```
# config t
(config)# default access-list rate-limiter 1
```

3.9.10 (config)# dot1x

3.9.10.1 (config)# dot1x system-auth-control

Syntax: (config)# dot1x system-auth-control

Explanation: To enable 802.1x service.

Example: Enable 802.1x service.

```
# config t
(config)# dot1x system-auth-control
```

Negation: (config)# no dot1x system-auth-control

Show: > show dot1x status [interface (<port_type> [<v_port_type_list>])] [brief]
show dot1x status [interface (<port_type> [<v_port_type_list>])] [brief]

3.9.10.2 (config)# dot1x re-authentication

Syntax: (config)# dot1x re-authentication

Explanation: Set clients to be re-authenticated after an interval set in "Re-authenticate" field. Re-authentication can be used to detect if a new device is attached to a switch port.

Example: Enable re-authentication function.

```
# config t
(config)# dot1x re-authentication
```

Negation: (config)# no dot1x re-authentication

Show: > show dot1x status [interface (<port_type> [<v_port_type_list>])] [brief]
show dot1x status [interface (<port_type> [<v_port_type_list>])] [brief]

3.9.10.3 (config)# dot1x authentication timer re-authenticate

Syntax: (config)# dot1x authentication timer re-authenticate <1-3600>

Explanation: Specify the time interval for a connected device to be re-authenticated. By default, the re-authenticated period is set to 3600 seconds. The allowed range is 1 - 3600 seconds.

Parameters:

<1-3600>: Specify a re-authentication value between 1 and 3600.

Example: Set re-authentication timer to 100.

```
# config t
(config)# dot1x authentication timer re-authenticate 100
```

Negation: (config)# no dot1x authentication timer re-authenticate

3.9.10.4 (config)# dot1x timeout tx-period

Syntax: (config)# dot1x timeout tx-period <v_1_to_65535>

Explanation: Specify the time that the switch waits for a supplicant response during an authentication session before transmitting a Request Identify EAPOL packet. By default, it is set to 30 seconds.

Parameters:

<v_1_to_65535>: Specify a timeout value between 1 and 65535 (seconds).

Example: Set EAPOL timeout to 30 seconds.

```
# config t
(config)# dot1x timeout tx-period 30
```

Negation: (config)# no dot1x timeout tx-period

3.9.10.5 (config)# dot1x authentication timer inactivity

Syntax: (config)# dot1x authentication timer inactivity <10-1000000>

Explanation: Specify the period that is used to age out a client's allowed access to the switch via 802.1X and MAC-based authentication. The default period is 300 seconds. The allowed range is 10 - 1000000 seconds.

Parameters:

<10-1000000>: Specify a value between 10 and 1000000 (seconds).

Example: Set the aging time to 300 seconds.

```
# config t
(config)# dot1x authentication timer inactivity 300
```

Negation: (config)# no dot1x authentication timer inactivity

3.9.10.6 (config)# dot1x timeout quiet-period

Syntax: (config)# dot1x timeout quiet-period <v_10_to_1000000>

Explanation: The time after an EAP Failure indication or RADIUS timeout that a client is not allowed access. This setting applies to ports running Single 802.1X, Multi 802.1X, or MAC-based authentication. By default, hold time is set to 10 seconds. The allowed range is 10 - 1000000 seconds.

Parameters:

<10-1000000>: Specify a value between 10 and 1000000 (seconds).

Example: Set hold time to 30 seconds.

```
# config t
(config)# dot1x timeout quiet-period 30
```

Negation: (config)# no dot1x timeout quiet-period

3.9.10.7 (config)# dot1x feature

Syntax: (config)# dot1x feature { [guest-vlan] [radius-qos] [radius-vlan] }

Explanation: Enable the specified feature.

Parameters:

{ [guest-vlan] [radius-qos] [radius-vlan] }:

[guest-vlan]: Enable guest VLAN. A Guest VLAN is a special VLAN typically with limited network access. When checked, the individual ports' ditto setting determines whether the port can be moved into Guest VLAN. When unchecked, the ability to move to the Guest VLAN is disabled on all ports.

[radius-qos]: Enable RADIUS assigned QoS.

[radius-vlan]: Enable RADIUS VLAN. RADIUS-assigned VLAN provides a means to centrally control the VLAN on which a successfully authenticated supplicant is placed on the switch. Incoming traffic will be classified to and switched on the RADIUS-assigned VLAN. The RADIUS server must be configured to transmit special RADIUS attributes to take advantage of this feature.

Example: Enable guest VLAN service.

```
# config t
(config)# dot1x feature guest-vlan
```

Negation: (config)# no dot1x feature { [guest-vlan] [radius-qos] [radius-vlan] }

3.9.10.8 (config)# dot1x guest-vlan

Syntax: (config)# dot1x guest-vlan <value>

Explanation: Configure a guest VLAN ID.

Parameters:

<value:1-4095>: Specify the guest VLAN ID. The allowed VLAN ID range is from 1 to 4095.

Negation: (config)# no dot1x guest-vlan

3.9.10.9 (config)# dot1x guest-vlan supplicant

Syntax: (config)# dot1x guest-vlan supplicant

Explanation: Enable Guest VLAN supplicant function. The switch remembers if an EAPOL frame has been received on the port for the life-time of the port. Once the switch considers whether to enter the Guest VLAN, it will first check if this option is enabled or disabled. When enabled, the switch does not maintain the EAPOL packet history and allows clients that fail authentication to access the guest VLAN, regardless of whether EAPOL packets had been detected on the interface. Clients that fail authentication can access the guest VLAN.

Negation: (config)# no dot1x guest-vlan supplicant

3.9.10.10 (config)# dot1x max-reauth-req

Syntax: (config)# dot1x max-reauth-req <value>

Explanation: The maximum number of times the switch transmits an EAPOL Request Identity frame without receiving a response before adding a port to the Guest VLAN. The value can only be changed when the Guest VLAN option is globally enabled. The range is 1 – 255.

Parameters:

<value:1-255>: Specify a value between 1 and 255.

Negation: (config)# no dot1x max-reauth-req

3.9.11 (config)# enable

3.9.11.1 (config)# enable password

Syntax: (config)# enable password <password>

Explanation: Configure enable password.

Parameters:

password <password>: Specify the enable mode password.

3.9.11.2 (config)# enable password level

Syntax: (config)# enable password [level <priv: 1-15>] <password>

Explanation: Configure enable password and privilege level.

Parameters:

[level <priv: 1-15>]: Specify the privilege level for this password.

<password>: Specify the enable mode password.

Negation: (config)# no enable password [level <priv>]

3.9.11.3 (config)# enable secret

Syntax: (config)# enable secret { 0 | 5 } [level <priv: 1-15>] <password>

Parameters:

{ 0 | 5 } : Specify "0" to denote unencrypted secret (cleartext). Specify "5" to denote encrypted secret (MD5).

[level <priv: 1-15>]: Specify the privilege level for this password.

<password>: Specify the enable mode password.

Explanation: Configure enable secret password and privilege level.

Negation: (config)# no enable secret { [0 | 5] } [level <priv>]

3.9.12 (config)# erps <inst>

Syntax: (config)# erps <inst>

Explanation: Create a new erps instance.

Parameters:

<inst: 1-64>: Specify a group instance. The allowed range is from 1 to 64.

Example: Create ERPS instance 1.

```
# config t
(config)# erps 1
(config-erps)#
```

Negation: (config)# no erps { <inst> | all }

Show: # show erps [<inst_list>] [statistics] [details]

3.9.12.1 (config-erps)# admin-state { enable | disable }

Syntax: (config-erps)# admin-state { enable | disable }

Explanation: Enable or disable this created ERPS instance.

Parameters:

{ enable | disable } : Enable or disable the specified ERPS instance.

Example: Enable ERPS instance 1.

```
# config t
(config)# erps 1
(config-erps)# admin-state enable
(config-erps)#
```

Show: # show erps [<inst_list>] [statistics] [details]

3.9.12.2 (config-erps)# control-vlan <vid> [pcp <pcp>]

Syntax: (config-erps)# control-vlan <vid> [pcp <pcp>]

Explanation: Specify VID and PCP of the Control VLAN. The Control VLAN is the VLAN on which R-APS PDUs are transmitted and received on the ring ports.

Parameters:

<vid>: Specify the VID for the Control VLAN.

[pcp <pcp>]: Specify PCP value for the Control VLAN.

Show: # show erps [<inst_list>] [statistics] [details]

3.9.12.3 (config-erps)# guard-time <guard_time>

Syntax: (config-erps)# guard-time <guard_time>

Explanation: Configure this ERPS instance's guard time.

Parameters:

<guard_time_ms: 0-2000>: Specify the guard time. The allowed range is 0 to 2000 ms.

Negation: (config-erps)# no guard-time <guard_time>

Show: # show erps [<inst_list>] [statistics] [details]

3.9.12.4 (config-erps)# hold-off-time <hold_off>

Syntax: (config-erps)# hold-off-time <hold_off>

Explanation: Configure this ERPS instance's holdoff time.

Parameters:

<holdoff_time_ms: 0-10000>: Specify the holdoff time. The allowed range is 0 to 10000 ms.

Negation: (config-erps)# no hold-off-time <hold_off>

Show: # show erps [<inst_list>] [statistics] [details]

3.9.12.5 (config-erps)# level <level>

Syntax: (config-erps)# level <level>

Explanation: Specify MD/MEG Level of R-APS PDUs.

Parameters:

<level>: Specify MD/MEG Level of R-APS PDUs. The allowed value is 0 to 7.

Show: # show erps [<inst_list>] [statistics] [details]

3.9.12.6 (config-erps)# node-id <node_id>

Syntax: (config-erps)# node-id <node_id>

Explanation: The Node ID is used inside the R-APS specific PDU to uniquely identify this node (switch) on the ring.

Parameters:

<node_id>: Specify the Node ID which is an unicast MAC address in xx:xx:xx:xx:xx format.

Negation: (config-erps)# no node-id

Show: # show erps [<inst_list>] [statistics] [details]

3.9.12.7 (config-erps)# port0 interface <port_type> <port>

Syntax: (config-erps)# port0 interface <port_type> <port>

Explanation: Specify Port 0's port type and port number.

Parameters:

<port_type> <port>: Specify Port 0's port type and port number. Port 0 is also known as E port (East port) which is used by some of the other vendors.

Show: # show erps [<inst_list>] [statistics] [details]

3.9.12.8 (config-erps)# port0 sf-trigger { link | { mep domain <md_name> service <ma_name> mep-id <mepid> } }

Syntax: (config-erps)# port0 sf-trigger { link | { mep domain <md_name> service <ma_name> mep-id <mepid> } }

Explanation: Specify port0's interface link state or specify a MEP installed on port0's interface that is used as signal-fail trigger.

Parameters:

{ link | { mep domain <md_name> service <ma_name> mep-id <mepid> } }: Specify whether Signal Fail (SF) comes from the link state of a given interface, or from a Down-MEP. For MEP, specify domain name, service name and MEP ID.

Show: # show erps [<inst_list>] [statistics] [details]

3.9.12.9 (config-erps)# port0 smac <mac>

Syntax: (config-erps)# port0 smac <mac>

Explanation: Set a source MAC address to be used in R-APS PDUs transmitted on port0. Default to use interface's.

Parameters:

<mac>: Specify a source MAC address to be used in R-APS PDUs transmitted on port0.

Negation: (config-erps)# no port0 smac

Show: # show erps [<inst_list>] [statistics] [details]

3.9.12.10 (config-erps)# port1 interface <port_type> <port>

Syntax: (config-erps)# port1 interface <port_type> <port>

Explanation: Specify Port 1's port type and port number.

Parameters:

<port_type> <port>: Specify Port 1's port type and port number.

Show: # show erps [<inst_list>] [statistics] [details]

3.9.12.11 (config-erps)# port1 sf-trigger { link | { mep domain <md_name> service <ma_name> mep-id <mepid> } }

Syntax: (config-erps)# port1 sf-trigger { link | { mep domain <md_name> service <ma_name> mep-id <mepid> } }

Explanation: Specify port1's interface link state or specify a MEP installed on port1's interface is used as signal-fail trigger.

Parameters:

{ link | { mep domain <md_name> service <ma_name> mep-id <mepid> } }: Specify whether Signal Fail (SF) comes from the link state of a given interface, or from a Down-MEP. For MEP, specify domain name, service name and MEP ID.

Show: # show erps [<inst_list>] [statistics] [details]

3.9.12.12 (config-erps)# port1 smac <mac>

Syntax: (config-erps)# port1 smac <mac>

Explanation: Set a source MAC address to be used in R-APS PDUs transmitted on port 1. Default to use interface's.

Parameters:

<mac>: Specify a source MAC address to be used in R-APS PDUs transmitted on port 1.

Negation: (config-erps)# no port1 smac

Show: # show erps [<inst_list>] [statistics] [details]

3.9.12.13 (config-erps)# protected-vlans <vlan_list>

Syntax: (config-erps)# protected-vlans <vlan_list>

Explanation: Configure VLANs which are protected by this ring instance.

Parameters:

<vlan_list>: At least one VLAN must be protected. For multiple VLANs, use a comma to separate VLAN numbers. For example, 1,4,7,30-70

Negation: (config-erps)# no protected-vlans

Show: # show erps [<inst_list>] [statistics] [details]

3.9.12.14 (config-erps)# revertive

Syntax: (config-erps)# revertive

Explanation: Set up revertive mode.

Negation: (config-erps)# no revertive

Show: # show erps [<inst_list>] [statistics] [details]

3.9.12.15 (config-erps)# ring-id <ring_id>

Syntax: (config-erps)# ring-id <ring_id>

Explanation: The Ring ID is used - along with the control VLAN - to identify R-APS PDUs as belonging to a particular ring.

Parameters:

<ring_id: 1-239>: Ring ID. If using G.8032 version 1, this must be 1.

Show: # show erps [<inst_list>] [statistics] [details]

3.9.12.16 (config-erps)# ring-type { major | sub-ring [virtual-channel] | interconnected-sub-ring { connected-ring <connected_ring_inst> [virtual-channel] [propagate-topology-change] } }

Syntax: (config-erps)# ring-type { major | sub-ring [virtual-channel] | interconnected-sub-ring { connected-ring <connected_ring_inst> [virtual-channel] [propagate-topology-change] } }

Explanation: Configure type of the ring.

Parameters:

{ major | sub-ring [virtual-channel] | interconnected-sub-ring { connected-ring <connected_ring_inst> [virtual-channel] [propagate-topology-change] } }: Possible values are as follows:

major: ERPS major ring (G.8001-2016, clause 3.2.39)

sub-ring: ERPS sub-ring (G.8001-2016, clause 3.2.66)

interconnected-sub-ring: ERPS sub-ring on an interconnection node (G.8001-2016, clause 3.2.66)

Show: # show erps [<inst_list>] [statistics] [details]

3.9.12.17 (config-erps)# rpl { owner | neighbor } { port0 | port1 }

Syntax: (config-erps)# rpl { owner | neighbor } { port0 | port1 }

Explanation: Specify the Ethernet ring port on the local node as the RPL (Ring Protection Link) owner or neighbor.

Parameters:

{ owner | neighbor }: Specify the ring port is a owner or neighbor. RPL (Ring Protection Link) is responsible for blocking traffic over the RPL so that no loops are formed in the Ethernet traffic.

{ port0 | port1 }: Specify the port applies to this rule.

Negation: (config-erps)# no rpl

Show: # show erps [<inst_list>] [statistics] [details]

3.9.12.18 (config-erps)# version { v1 | v2 }

Syntax: (config-erps)# version { v1 | v2 }

Explanation: Configure ERPS version for a specific profile.

Parameters:

{ 1 | 2 }: Specify ERPS version 1 or 2.

Show: # show erps [<inst_list>] [statistics] [details]

3.9.12.19 (config-erps)# wait-to-restore <wtr>

Syntax: (config-erps)# wait-to-restore <wtr>

Explanation: Configure the Wait-to-Restore timer in revertive mode.

Parameters:

<wtr_time_minutes:1-720>: Specify Wait-to-Restore timer in minutes. The allowed range is from 1 to 720 seconds.

Negation: (config-erps)# no wait-to-restore <wtr>

Show: # show erps [<inst_list>] [statistics] [details]

3.9.13 (config)# green-ethernet

3.9.13.1 (config)# green-ethernet led interval

Syntax: (config)# green-ethernet led interval <v_0_to_24> intensity <v_0_to_100>

Explanation: Configure the LED time interval and LED light intensity to reduce power consumption.

Parameters:

led interval <v_0_to_24>: Specify LED time interval. The first value is the starting time. The second one is the ending time. The allowed value is from 0 to 24.

intensity <v_0_to_100>: LED intensity. The value is from 0 to 100.

Example: LED intensity reduces to 80% during 9:00 and 18:00.

```
# config t
(config)# green-ethernet led interval 9-18 intensity 80
```

Negation: (config)# no green-ethernet led interval <0~24>

3.9.13.2 (config)# green-ethernet led on-event

Syntax: (config)# green-ethernet led on-event { [link-change <v_0_to_65535>] [error] }

Explanation: The switch will bring LED intensity to 100% for the specified period in the event of any error (such as link down).

Parameters:

[link-change <v_0_to_65535>]: Specify how long LED intensity 100% lasts when errors occur. The allowed value is from 0 to 65535.

[error]: Bring LED intensity to 100% in the event of errors.

Example: Bring LED intensity to 100% for 10 minutes when errors occur.

```
# config t
(config)# green-ethernet led on-event link-change 600 error
```

Negation: (config)# no green-ethernet led on-event [link-change] [error]

3.9.13.3 (config)# green-ethernet eee optimize-for-power

Syntax: (config)# green-ethernet eee optimize-for-power

Explanation: Enables the EEE function for this switch.

Example: Enable EEE function for optimized power.

```
# config t
(config)# green-ethernet eee optimize-for-power
```

Negation: (config)# no green-ethernet eee optimize-for-power

show: # show green-ethernet [interface (<port_type> [<port_list>])]
 # show green-ethernet eee [interface (<port_type> [<port_list>])]
 # show green-ethernet energy-detect [interface (<port_type> [<port_list>])]
 # show green-ethernet short-reach [interface (<port_type> [<port_list>])]

3.9.14 (config)# gvrp

3.9.14.1 (config)# gvrp

Syntax: (config)# gvrp

Explanation: Globally enable GVRP function.

Example: Globally enable GVRP function.

```
# config t
(config)# gvrp
(config)#
```

Negation: (config)# no gvrp

3.9.14.2 (config)# gvrp max-vlans

Syntax: (config)# gvrp max-vlans <maxvlans>

Explanation: Set up the maximum number of VLANs can be learned via GVRP.

Parameters:

<maxvlans>: Specify the number of VLANs learned via GVRP.

Example: Set the maximum number of VLANs can be learned via GVRP to 20.

```
# config t
(config)# gvrp
(config)# gvrp max-vlans 20
```

Negation: (config)# no gvrp max-vlans <maxvlans>

3.9.14.3 (config)# gvrp time

Syntax: (config)# gvrp time { [join-time <jointime>] [leave-time <leavetime>] [leave-all-time <leavealltime>] }

Explanation: Set up the maximum number of VLANs can be learned via GVRP.

Parameters:

[join-time <jointime>]: Specify the amount of time in units of centi-seconds that PDUs are transmitted. The default value is 20 centi-seconds. The valid value is 1~20.

[leave-time <leavetime>]: Specify the amount of time in units of centi-seconds that the device waits before deleting the associated entry. The leave time is activated by a "Leave All-time" message sent/received and cancelled by the Join message. The default value is 60 centi-seconds.

NOTE: The "LeaveAll-time" parameter must be greater than the "Leave-time" parameter.

[leave-all-time <leavealltime>]: Specify the amount of time that "LeaveAll" PDUs are created. A LeaveAll PDU indicates that all registrations are shortly de-registered. Participants will need to rejoin in order to maintain registration. The valid value is 1000 to 5000 centi-seconds. The factory default 1000 centi-seconds.

NOTE: The "LeaveAll-time" parameter must be greater than the "Leave-time" parameter.

Negation: (config)# no gvrp time { [join-time <jointime>] [leave-time <leavetime>] [leave-all-time <leavealltime>] }

3.9.15 (config)# hostname

Syntax: (config)# hostname <WORD>

Explanation: Specify a descriptive name for this switch.

Parameters:

<WORD32>: Specify a descriptive name for this device. Indicate the hostname for this device. Alphabets (A-Z; a-z), digits (0-9) and minus sign (-) can be used. However, space characters are not allowed. The first character must be an alphabet character. The first and last character must not be a minus sign. The allowed string length is 0 – 255.

Example: Set the hostname to AccessSW.

```
# config t
(config)# hostname AccessSW
AccessSW(Config)#
```

Negation: (config)# no hostname

Show: > show version
show version

3.9.16 (config)# interface

3.9.16.1 (config)# interface (<port_type> [<plist>])

Syntax: (config)# interface (<port_type> [<plist>])

Explanation: Enter Config Interface mode for this specific interface.

Parameters:

<port_type> [<plist>]: Specify the port type and port number.

Example: Enter Config Interface mode for Fast Ethernet port 1.

```
# config t
(config)#
(config)# interface FastEthernet 1/1
(config-if)#
```

Show: > show interface (<port_type> [<in_port_list>]) switchport [access | trunk | hybrid]
 > show interface (<port_type> [<v_port_type_list>]) capabilities
 > show interface (<port_type> [<v_port_type_list>]) statistics [{ packets | bytes | errors | discards | filtered |
 { priority [<priority_v_0_to_7>] }] [{ up | down }]
 > show interface (<port_type> [<v_port_type_list>]) status
 > show interface (<port_type> [<v_port_type_list>]) utp-cable-diagnostic
 > show interface vlan [<vlist>]

```
# show interface ( <port_type> [ <in_port_list> ] ) switchport [ access | trunk | hybrid ]
# show interface ( <port_type> [ <v_port_type_list> ] ) capabilities
# show interface ( <port_type> [ <port_list> ] ) description
# show interface ( <port_type> [ <port_list> ] ) statistics [ { packets | bytes | errors | discards | filtered |
{ priority [ <priority_list> ] } | link-state-changes } ] [ { up | down } ]
# show interface ( <port_type> [ <v_port_type_list> ] ) status
# show interface ( <port_type> [ <port_list> ] ) transceiver
# show interface ( <port_type> [ <port_list> ] ) veriphy
# show interface vlan [ <vlist> ]
```

Clear: # clear statistics { [interface] (<port_type> [<v_port_type_list>]) }

3.9.16.2 (config)# interface llag

Syntax: (config)# interface llag <llag_id:1~10>

Explanation: Enter Config Interface Aggregation Group mode for this specific interface.

Example: Enter Aggregation Group ID 3.

```
# config t
(config)#
(config)# interface llag 3
(config-llag)#
```

3.9.16.2.1 (config-llag)# lacp failover

Syntax: (config-llag)# lacp failover { revertive | non-revertive }

Explanation: This parameter only applies to LACP-Enabled groups. It determines if the group will perform automatic link (re)calculation when links with higher priority becomes available.

Negation: (config-llag)# no lacp failover [revertive | non-revertive]

3.9.16.2 (config-lag)# lacp max-bundle

Syntax: (config-lag)# lacp max-bundle <v_uint>

Explanation: This parameter only applies to LACP-Enabled groups. It determines the maximum number of active bundled LACP ports allowed in an aggregation.

Negation: (config-lag)# no lacp max-bundle [<uint>]

3.9.16.3 (config)# interface vlan

Syntax: (config)# interface vlan <vlist>

Explanation: Enter Config Interface VLAN mode for this specific interface.

Example: Enter Config Interface VLAN 1 for Fast Ethernet port 1.

```
# config t
(config)#
(config)# interface vlan 1
(config-if-vlan)#
```

3.9.17 (config)# ip

3.9.17.1 (config)# ip arp inspection

Syntax: (config)# ip arp inspection

Explanation: Enable ARP inspection function.

Negation: (config)# no ip arp inspection

Show: > show ip arp inspection [interface (<port_type> [<in_port_type_list>]) | vlan <in_vlan_list>]
show ip arp inspection [interface (<port_type> [<in_port_type_list>]) | vlan <in_vlan_list>]

Clear: # clear ip arp

3.9.17.2 (config)# ip arp inspection entry interface

Syntax: (config)# ip arp inspection entry interface <port_type> <in_port_type_id> <vlan_var> <mac_var> <ipv4_var>

Explanation: Create ARP static entry.

Parameters:

<port_type> <in_port_type_id>: Specify the port type and port number.

<vlan_var>: Specify a configured VLAN ID.

<mac_var>: Specify an allowed source MAC address in ARP request packets.

<ipv4_var>: Specify an allowed source IP address in ARP request packets.

Negation: (config)# no ip arp inspection entry interface <port_type> <in_port_type_id> <vlan_var> <mac_var> <ipv4_var>

Show: # show ip arp inspection entry [dhcp-snooping | static] [interface (<port_type> [<in_port_type_list>])]

Clear: # clear ip arp

3.9.17.3 (config)# ip arp inspection translate

Syntax: (config)# ip arp inspection translate [interface <port_type> <in_port_type_id> <vlan_var> <mac_var> <ipv4_var>]

Explanation: Translate the dynamic entry to static one.

Parameters:

<port_type> <in_port_type_id>: Specify the port type and port number.

<vlan_var>: Specify a configured VLAN ID.

<mac_var>: Specify an allowed source MAC address in ARP request packets.

<ipv4_var>: Specify an allowed source IP address in ARP request packets.

Show: # show ip arp inspection entry [dhcp-snooping | static] [interface (<port_type> [<in_port_type_list>])]

3.9.17.4 (config)# ip arp inspection vlan

Syntax: (config)# ip arp inspection vlan <in_vlan_list>

Explanation: Specify ARP inspection is enabled on which VLAN.

Parameters:

<in_vlan_list>: Specify a list of VLAN ID to be used for ARP inspection.

Negation: (config)# no ip arp inspection vlan <in_vlan_list>

Show: < show ip arp
show ip arp

Clear: # clear ip arp

3.9.17.5 (config)# ip arp inspection vlan <in_vlan_list> logging

Syntax: (config)# ip arp inspection vlan <in_vlan_list> logging { deny | permit | all }

Explanation: Enable log function.

Parameters:

{ deny | permit | all }: Specify one of the log types.

Deny: Log denied entries.

Permit: Log permitted entries.

All: Log all entries.

Negation: (config)# no ip arp inspection vlan <in_vlan_list> logging

Show: < show ip arp
show ip arp

Clear: # clear ip arp

3.9.17.6 (config)# ip dhcp excluded-address

Syntax: (config)# ip dhcp excluded-address <low_ip> [<high_ip>]

Explanation: Exclude IP range from the IP pool. In other words, the specified IP range will not be assigned to DHCP clients.

Parameters:

<low_ip> [<high_ip>]: Enter the starting and ending IP address that are not allocated to DHCP clients. The starting IP address must be smaller or equal to the ending IP address. If there is only one excluded IP address, it can be entered either in starting or ending IP address field. The total Excluded IP address ranges can be supported is 16.

Negation: (config)# no ip dhcp excluded-address <low_ip> [<high_ip>]

Show: < show ip dhcp excluded-address
show ip dhcp excluded-address

3.9.17.7 (config)# ip dhcp pool

Syntax: (config)# ip dhcp pool <pool_name>

Explanation: Create a DHCP pool.

Parameters:

<pool_name>: Specify the pool name. All printable characters are supported except white space.

Negation: (config)# no ip dhcp pool <pool_name>

Show: < show ip dhcp pool [<pool_name>]
show ip dhcp pool [<pool_name>]

3.9.17.7.1 (config-dhcp-pool)# broadcast

Syntax: (config-dhcp-pool)# broadcast <ip>

Explanation: Specify the broadcast address in use on the client's subnet for the specified IP dhcp pool.

Parameters:

<ip>: Specify the broadcast address in use on the client's subnet

Negation: (config-dhcp-pool)# no broadcast

Show: < show ip dhcp pool [<pool_name>]
show ip dhcp pool [<pool_name>]

3.9.17.7.2 (config-dhcp-pool)# client-identifier

Syntax: (config-dhcp-pool)# client-identifier { fqdn <identifier> | mac-address <mac> }

Explanation: Specify client's unique identifier to be used when the pool is the type of host.

Parameters:

{ fqdn <identifier> | mac-address <mac> }: Specify the client identifier either in FQDN (Fully Qualified Domain Name) or MAC address format.

Negation: (config-dhcp-pool)# no client-identifier

Show: < show ip dhcp pool [<pool_name>]
show ip dhcp pool [<pool_name>]

3.9.17.7.3 (config-dhcp-pool)# client-name

Syntax: (config-dhcp-pool)# client-name <host_name>

Explanation: Specify the name of client to be used when the pool is the type of host.

Parameters:

<host_name>: Specify the name of client to be used when the pool is the type of host.

Negation: (config-dhcp-pool)# no client-name

Show: < show ip dhcp pool [<pool_name>]
show ip dhcp pool [<pool_name>]

3.9.17.7.4 (config-dhcp-pool)# default-router

Syntax: (config-dhcp-pool)# default-router <ip> [<ip1> [<ip2> [<ip3>]]]

Explanation: Specify a list of IP addresses for routers on the clients' subnet.

Parameters:

<ip> [<ip1> [<ip2> [<ip3>]]]: Specify a list of IP addresses for routers on the clients' subnet.

Negation: (config-dhcp-pool)# no default-router

Show: < show ip dhcp pool [<pool_name>]
show ip dhcp pool [<pool_name>]

3.9.17.7.5 (config-dhcp-pool)# dns-server

Syntax: (config-dhcp-pool)# dns-server <ip> [<ip1> [<ip2> [<ip3>]]]

Explanation: Specify a list of Domain Name System name servers available to the client.

Parameters:

<ip> [<ip1> [<ip2> [<ip3>]]]: Specify a list of Domain Name Servers available to the client.

Negation: (config-dhcp-pool)# no dns-server

Show: < show ip dhcp pool [<pool_name>]
show ip dhcp pool [<pool_name>]

3.9.17.7.6 (config-dhcp-pool)# domain-name

Syntax: (config-dhcp-pool)# domain-name <domain_name>

Explanation: Specify a list of Domain Name System name servers available to the client.

Parameters:

<domain_name>: Specify the domain name that a client use when resolving hostname via DNS.

Negation: (config-dhcp-pool)# no domain-name

Show: < show ip dhcp pool [<pool_name>]
show ip dhcp pool [<pool_name>]

3.9.17.7.7 (config-dhcp-pool)# hardware-address

Syntax: (config-dhcp-pool)# hardware-address <mac>

Explanation: Specify client's hardware (MAC) address to be used when the pool is the type of host.

Parameters:

<mac>: Specify client's hardware (MAC) address to be used when the pool is the type of host.

Negation: (config-dhcp-pool)# no hardware-address

Show: < show ip dhcp pool [<pool_name>]
show ip dhcp pool [<pool_name>]

3.9.17.7.8 (config-dhcp-pool)# host

Syntax: (config-dhcp-pool)# host <ip> <subnet_mask>

Explanation: Specify the Network IP and subnet mask of the DHCP address pool.

Parameters:

<ip>: Specify the network IP of the DHCP address pool.

<subnet_mask>: Specify subnet mask of the DHCP address pool.

Negation: (config-dhcp-pool)# no host

Show: < show ip dhcp pool [<pool_name>]
show ip dhcp pool [<pool_name>]

3.9.17.7.9 (config-dhcp-pool)# lease

Syntax: (config-dhcp-pool)# lease { <day> [<hour> [<min>]] | infinite }

Explanation: Specify lease time that a client needs to send requests to the DHCP server for renewed IP address.

Parameters:

{ <day> [<hour> [<min>]] | infinite }: Specify lease time that a client needs to send requests to the DHCP server for renewed IP address. Specify "infinite" to mean the lease time is infinite.

Negation: (config-dhcp-pool)# no lease

Show: < show ip dhcp pool [<pool_name>]
show ip dhcp pool [<pool_name>]

3.9.17.7.10 (config-dhcp-pool)# netbios-name-server

Syntax: (config-dhcp-pool)# netbios-name-server <ip> [<ip1> [<ip2> [<ip3>]]]

Explanation: Specify a list of NBNS name servers.

Parameters:

[<ip1> [<ip2> [<ip3>]]]: Specify a list of NBNS name servers IP in order of preference.

Negation: (config-dhcp-pool)# no netbios-name-server

Show: < show ip dhcp pool [<pool_name>]
show ip dhcp pool [<pool_name>]

3.9.17.7.11 (config-dhcp-pool)# netbios-node-type

Syntax: (config-dhcp-pool)# netbios-node-type { b-node | h-node | m-node | p-node }

Explanation: Specify NetBIOS node type option to allow Netbios over TCP/IP clients as described in RFC 1001/1002.

Parameters:

{ b-node | h-node | m-node | p-node }: Specify NetBIOS node type.

Negation: (config-dhcp-pool)# no netbios-node-type

Show: < show ip dhcp pool [<pool_name>]
show ip dhcp pool [<pool_name>]

3.9.17.7.12 (config-dhcp-pool)# netbios-scope

Syntax: (config-dhcp-pool)# netbios-scope <netbios_scope>

Explanation: Specify the NetBIOS over TCP/IP scope parameter for the client as specified in RFC 1001/1002.

Parameters:

<netbios_scope>: Specify NetBIOS scope identifier.

Negation: (config-dhcp-pool)# no netbios-scope

Show: < show ip dhcp pool [<pool_name>]
show ip dhcp pool [<pool_name>]

3.9.17.7.13 (config-dhcp-pool)# network

Syntax: (config-dhcp-pool)# network <ip> <subnet_mask>

Explanation: The pool defines a pool of IP addresses to service more than one DHCP client

Parameters:

<ip> <subnet_mask>: Specify IP address and subnet mask for this specific IP address.

Negation: (config-dhcp-pool)# no network

Show: < show ip dhcp pool [<pool_name>]
show ip dhcp pool [<pool_name>]

3.9.17.7.14 (config-dhcp-pool)# nis-domain-name

Syntax: (config-dhcp-pool)# nis-domain-name <domain_name>

Explanation: Specify the name of the client's NIS domain.

Parameters:

<domain_name>: Specify NIS domain name.

Negation: (config-dhcp-pool)# no nis-domain-name

Show: < show ip dhcp pool [<pool_name>]
show ip dhcp pool [<pool_name>]

3.9.17.7.15 (config-dhcp-pool)# nis-server

Syntax: (config-dhcp-pool)# nis-server <ip> [<ip1> [<ip2> [<ip3>]]]

Explanation: Specify a list of IP addresses indicating NIS servers available to the client.

Parameters:

[<ip1> [<ip2> [<ip3>]]]: Specify a list of IP addresses indicating NIS servers available to the client.

Negation: (config-dhcp-pool)# no nis-server

Show: < show ip dhcp pool [<pool_name>]
show ip dhcp pool [<pool_name>]

3.9.17.7.16 (config-dhcp-pool)# ntp-server

Syntax: (config-dhcp-pool)# ntp-server <ip> [<ip1> [<ip2> [<ip3>]]]

Explanation: Specify a list of IP addresses indicating NTP servers available to the client.

Parameters:

[<ip1> [<ip2> [<ip3>]]]: Specify a list of IP addresses indicating NTP servers available to the client.

Negation: (config-dhcp-pool)# no ntp-server

Show: < show ip dhcp pool [<pool_name>]
show ip dhcp pool [<pool_name>]

3.9.17.7.17 (config-dhcp-pool)# vendor class-identifier

Syntax: (config-dhcp-pool)# vendor class-identifier <class_id> specific-info <hexval>

Explanation: Identify the vendor type and vendor specific information. DHCP server will deliver the corresponding option 43 specific information to the client that sends option 60 vendor class identifier.

Parameters:

<class_id>: Specify the specific vendor class identifier (option 60).

<hexval>: Specify specific information.

Negation: (config-dhcp-pool)# no vendor class-identifier <class_id>

Show: < show ip dhcp pool [<pool_name>]
show ip dhcp pool [<pool_name>]

3.9.17.8 (config)# ip dhcp relay

Syntax: (config)# ip dhcp relay

Explanation: Enable DHCP relay function.

Example: Enable DHCP relay function.

```
# config t
(config)# ip dhcp relay
```

Negation: (config)# no ip dhcp relay

Show: > show ip dhcp relay [statistics]
show ip dhcp relay [statistics]

Clear: # clear ip dhcp relay statistics

3.9.17.9 (config)# ip dhcp relay information option

Syntax: (config)# ip dhcp relay information option

Explanation: Enable DHCP Relay option 82 function. Please note that “Relay Mode” must be enabled before this function is able to take effect.

Example: Enable DHCP Relay option 82 function

```
# config t
(config)# ip dhcp relay information option
```

Negation: (config)# no ip dhcp relay information option

3.9.17.10 (config)# ip dhcp relay information policy {drop | keep | replace}

Syntax: (config)# ip dhcp relay information policy { drop | keep | replace }

Explanation: Specify DHCP Relay information policy action.

Parameters:

{ drop | keep | replace }: Specify one of the relay information policy options.

drop: Drop the packet when it receives a DHCP message that already contains relay information.

keep: Keep the client’s DHCP information.

replace: Replace the DHCP client packet information with the switch’s relay information. This is the default setting.

Example: Keep the client’s DHCP information.

```
# config t
(config)# ip dhcp relay information policy keep
```

Negation: (config)# no ip dhcp relay information policy

3.9.17.11 (config)# ip dhcp server

Syntax: (config)# ip dhcp server

Explanation: Enable DHCP server function globally. When DHCP snooping mode operation is enabled, the DHCP request messages will be forwarded to trusted ports and only allow reply packets from trusted ports.

Negation: (config)# no ip dhcp server

Show: > show ip dhcp server
show ip dhcp server

3.9.17.12 (config)# ip dhcp snooping

Syntax: (config)# ip dhcp snooping

Explanation: Enable DHCP snooping function globally. When DHCP snooping mode operation is enabled, the DHCP request messages will be forwarded to trusted ports and only allow reply packets from trusted ports.

Example: Enable DHCP snooping function.

```
# config t
(config)# ip dhcp snooping
```

Negation: (config)# no ip dhcp snooping

Show: > show ip dhcp snooping [interface (<port_type> [<in_port_list>])]
 # show ip dhcp snooping [interface (<port_type> [<in_port_list>])]
 # show ip dhcp snooping table

Clear: # clear ip dhcp snooping statistics [interface (<port_type> [<in_port_list>])]

3.9.17.13 (config)# ip dns proxy

Syntax: (config)# ip dns proxy

Explanation: Enable DNS (Domain Name System) proxy function.

```
# config t
(config)# ip dns proxy
```

Negation: (config)# no ip dns proxy

3.9.17.14 (config)# ip domain name

Syntax: (config)# ip domain name { <v_domain_name> | <dhcp [ipv4 | ipv6] | [interface <v_vlan_id_dhcp>] }

Explanation: Configure a domain name for this device.

Parameters:

{ <v_domain_name> | <dhcp [ipv4 | ipv6] | [interface <v_vlan_id_dhcp>] }: Specify a domain name manually, or by DHCP or by indicating an interface.

Negation: (config)# no ip domain name

3.9.17.15 (config)# ip helper-address

Syntax: (config)# ip helper-address <v_ipv4_ucast>

Explanation: Configure DHCP Relay server IPv4 address.

Parameters:

<v_ipv4_ucast>: Specify DHCP Relay server IPv4 address that is used by the switch's DHCP relay agent

Negation: (config)# no ip helper-address

3.9.17.16 (config)# ip http secure-certificate

Syntax: (config)# ip http secure-certificate { upload <url_file> [pass-phrase <pass_phrase>] | delete | generate }

Explanation: Upload or generate HTTPS certificate.

Parameters:

{ upload <url_file> [pass-phrase <pass_phrase>] | delete | generate }: Upload a certificate via URL link and protected by a passphrase if necessary. You can also delete or generate a certificate by issuing "delete" or "generate" command.

Show: # show ip http

3.9.17.17 (config)# ip http secure-server

Syntax: (config)# ip http secure-server

Explanation: Enable the HTTPS operation mode. When the current connection is HTTPS and HTTPS mode operation is disabled, web browser will automatically redirect to an HTTP connection.

Example: Enable the HTTPS operation mode.

```
# config t
(config)# ip http secure-server
```

Negation: (config)# no ip http secure-server

Show: # show ip http server secure status

3.9.17.18 (config)# ip http secure-redirect

Syntax: (config)# ip http secure-redirect

Explanation: Enable the HTTPS redirect mode operation. It applies only if HTTPS mode is "Enabled". Automatically redirects HTTP of web browser to an HTTPS connection when both HTTPS mode and Automatic Redirect are enabled.

Example: Enable HTTPs automatic redirect mode.

```
# config t
(config)# ip http secure-redirect
```

Negation: (config)# no ip http secure-redirect

Show: # show ip http server secure status

3.9.17.19 (config)# ip igmp host-proxy

Syntax: (config)# ip igmp host-proxy [leave-proxy]

Explanation: When enabled, the switch suppresses leave messages unless received from the last member port in the group. IGMP leave proxy suppresses all unnecessary IGMP leave messages so that a non-querier switch forwards an IGMP leave packet only when the last dynamic member port leaves a multicast group.

Parameters:

[leave-proxy]: The parameter is optional. Enable leave-proxy function.

Negation: (config)# no ip igmp host-proxy [leave-proxy]

Show: # show ip igmp snooping detail

3.9.17.20 (config)# ip igmp snooping

Syntax: (config)# ip igmp snooping

Explanation: Globally enable IGMP Snooping feature. When enabled, this device will monitor network traffic and determine which hosts will receive multicast traffic. The switch can passively monitor or snoop on IGMP Query and Report packets transferred between IP multicast routers and IP multicast service subscribers to identify the multicast group members. The switch simply monitors the IGMP packets passing through it, picks out the group registration information and configures the multicast filters accordingly.

Negation: (config)# no ip igmp snooping

Show: # show ip igmp snooping [vlan <v_vlan_list>] [group-database [interface (<port_type> [<v_port_type_list>])] [sfm-information]] [detail]

Clear: # clear ip igmp snooping [vlan <v_vlan_list>] statistics

3.9.17.21 (config)# ip igmp snooping vlan

Syntax: (config)# ip igmp snooping vlan <v_vlan_list>

Explanation: Enable IGMP function for specific VLANs.

Parameters:

<v_vlan_list>: Specify valid IGMP VLANs.

Negation: (config)# no ip igmp snooping vlan [<v_vlan_list>]

Show: # show ip igmp snooping

Clear: # clear ip igmp snooping [vlan <v_vlan_list>] statistics

3.9.17.22 (config)# ip igmp ssm-range

Syntax: (config)# ip igmp ssm-range <v_ipv4_mcast> <ipv4_prefix_length>

Explanation: SSM (Source-Specific Multicast) Range allows the SSM-aware hosts and routers run the SSM service model for the groups in the address range.

Parameters:

<v_ipv4_mcast>: Specify valid IPv4 multicast address.

<ipv4_prefix_length>: Specify the prefix length ranging from 4 to 32.

Negation: (config)# no ip igmp ssm-range

3.9.17.23 (config)# ip igmp unknown-flooding

Syntax: (config)# ip igmp unknown-flooding

Explanation: Set forwarding mode for unregistered (not-joined) IP multicast traffic. Select the checkbox to flood traffic.

Negation: (config)# no ip igmp unknown-flooding

3.9.17.24 (config)# ip name-server

Syntax: (config)# ip name-server [<order: 0-2>] { <v_ipv4_ucast> | { <v_ipv6_ucast> [interface vlan <v_vlan_id_static>] } | dhcp [ipv4 | ipv6] [interface vlan <v_vlan_id_dhcp>] }

Explanation: Set up DNS IP address manually (IPv4 or IPv6) or obtain DNS IP address via specific VLAN DHCP server.

Parameters:

[<order>]: Specify the number of this name server. The allowed number is 0 through 2.

{ <v_ipv4_ucast> | { <v_ipv6_ucast> [interface vlan <v_vlan_id_static>] } | dhcp [ipv4 | ipv6] [interface vlan <v_vlan_id_dhcp>] }: Specify IPv4, IPv6 or DHCP interface.

<v_ipv4_ucast>: Manually specify unicast IPv4 name server address.

{ <v_ipv6_ucast> [interface vlan <v_vlan_id_static>] }: Manually specify IPv6 name server address.

dhcp [ipv4 | ipv6] [interface vlan <v_vlan_id_dhcp>]: Configure DNS IP address via specific VLAN DHCP server.

Negation: (config)# no ip name-server <order: 0-2>

Show: > show ip name-server
show ip name-server

3.9.17.25 (config)# ip route

Syntax: (config)# ip route <v_ipv4_addr> <v_ipv4_netmask> <v_ipv4_gw> [distance <v_distance>]

Explanation: Configure a static IP route.

Parameters:

<v_ipv4_addr>: Specify IPv4 address. The IP route is the destination IP network or host address of this route. Valid format is dotted decimal notation.

<v_ipv4_netmask>: The route mask is a destination IP network or host mask, in number of bits (prefix length). It defines how much of a network address that must match, in order to qualify for this route. Only a default route will have a mask length of 0 (as it will match anything).

<v_ipv4_gw>: This is the IP address of the gateway. Valid format is dotted decimal notation. Gateway and Network must be of the same type.

[distance <v_distance>]: Specify a distance value (1~255) to this route.

Example: Add a new ip route with the following settings.

```
# config t
(config)# ip route 192.168.1.240 255.255.255.0 192.168.1.254
```

Negation: (config)# no ip route <v_ipv4_subnet> <v_ipv4_gw> [distance <v_distance>]

Show: > show ip route
show ip route

3.9.17.26 (config)# ip routing

Syntax: (config)# ip routing

Explanation: Enable IPv4 and IPv6 routing.

Example: Enable IPv4 and IPv6 routing.

```
# config t
(config)# ip routing
```

Negation: (config)# no ip routing

Show: > show ip route

```
> show ipv6 route [interface vlan <vlan_list>]
# show ip route
# show ipv6 route [interface vlan<vlan_list>]
```

```
# show ip route
127.0.0.1/32 via 127.0.0.1 <UP HOST>
224.0.0.0/4 via 127.0.0.1 <UP>
# show ipv6 route interface vlan 1
::1/128 via ::1 <UP HOST>
```

3.9.17.27 (config)# ip source binding interface

Syntax: (config)# ip source binding interface <port_type> <in_port_type_id> <vlan_var> <ipv4_var> <mac_var>

Explanation: Create a static entry.

Parameters:

<port_type> <in_port_type_id>: Specify a port type and port number to which a static entry is bound.

<vlan_var>: Specify VLAN ID that has been configured.

<ipv4_var>: Specify a valid IPv4 address.

<mac_var>: Specify a MAC address for the entered IP address.

Negation: (config)# no ip source binding interface <port_type> <in_port_type_id> <vlan_var> <ipv4_var> <mac_var>

Show: # show ip source binding [dhcp-snooping | static] [interface (<port_type> [<in_port_type_list>])]

3.9.17.28 (config)# ip ssh

Syntax: (config)# ip ssh

Explanation: Enable SSH mode.

Example: Enable SSH mode.

```
# config t
(config)# ip ssh
```

Negation: (config)# no ip ssh

Show: # show ip ssh

NOTE: SSH is preferred to Telnet, unless the management network is trusted. Telnet passes authentication credentials in plain text, making those credentials susceptible to packet capture and analysis. SSH provides a secure authentication method. The SSH in this device uses version 2 of SSH protocol.

3.9.17.29 (config)# ip verify source

Syntax: (config)# ip verify source

Explanation: Enable IP source guard function.

Negation: (config)# no ip verify source

Show: > show ip verify source [interface (<port_type> [<in_port_type_list>])]
show ip verify source [interface (<port_type> [<in_port_type_list>])]

3.9.17.30 (config)# ip verify source translate

Syntax: (config)# ip verify source translate

Explanation: Translate Dynamic entries to Static ones.

3.9.18 (config)# ipmc

3.9.18.1 (config)# ipmc profile

Syntax: (config)# ipmc profile

Explanation: Enable IPMC (IP multicast) profile globally.

Negation: (config)# no ipmc profile

Show: # show ipmc profile

3.9.18.2 (config)# ipmc profile <profile_name>

Syntax: (config)# ipmc profile <profile_name>

Parameters:

<profile_name: word16>: Specify the desired profile name in 16 characters. When entered is pressed, the command will change to (config-ipmc-profile)#.

Explanation: Set up an IPMC profile.

Example: Create an IPMC profile named "goldpass".

```
# config t
(config)# ipmc profile goldpass
(config-ipmc-profile)#
```

Negation: (config)# no ipmc profile <profile_name>

Show: # show ipmc profile [<profile_name>] [detail]

3.9.18.3 (config)# ipmc range

Syntax: (config)# ipmc range <entry_name> { <v_ipv4_mcast> [<v_ipv4_mcast_1>] | <v_ipv6_mcast> [<v_ipv6_mcast_1>] }

Explanation: Specify the multicast IP range. The available IP range is from 224.0.0.0~239.255.255.255.

Parameters:

<entry_name>: The name used in specifying the address range.

{ <v_ipv4_mcast> [<v_ipv4_mcast_1>] | <v_ipv6_mcast> [<v_ipv6_mcast_1>] }: Specify the multicast IP range. The available IP range is from 224.0.0.0~239.255.255.255.

Negation: (config)# no no ipmc range <entry_name>

Show: # show ipmc profile [<profile_name>] [detail]

3.9.18.4 (config-ipmc-profile)# default range

Syntax: (config-ipmc-profile)# default range <entry_name>

Parameters:

<entry_name: word16>: Specify an entry name in 16 characters for this IPMC profile.

Explanation: To set default IPMC Profile Rule for a specific IPMC Profile.

Example: To default IPMC Profile Rule (Entry 1) for specific IPMC Profile.

```
# config t
(config)# ipmc profile goldpass
(config-ipmc-profile)# default range 1
```

Negation: (config-ipmc-profile)# no range <entry_name>

Show: # show ipmc profile
#show ipmc profile [<profile_name>] [detail]

3.9.18.5 (config-ipmc-profile)# description

Syntax: (config-ipmc-profile)# description <profile_desc>

Parameters:

<profile_desc: line 64>: Additional description for the designated profile in 64 characters.

Explanation: Specify descriptive information for the designated profile.

Example: Provide descriptive information for IPMC profile goldpass.

```
# config t
(config)# ipmc profile goldpass
(config-ipmc-profile)# description 1stclasscustomer
```

Negation: (config-ipmc-profile)# no description

Show: # show ipmc profile
#show ipmc profile [<profile_name>] [detail]

3.9.18.6 (config-ipmc-profile)# range

Syntax: (config-ipmc-profile)# range <entry_name> { permit | deny } [log] [next <next_entry>]

Parameters:

<entry_name>: Specify an entry name.

{ permit | deny }: Specify the action taken upon receiving the Join/Report frame that has the group address matches the address range of the rule.

Permit: Group address matches the range specified in the rule will be learned.

Deny: Group address matches the range specified in the rule will be dropped.

[log]: Log when matching

[next <next_entry>]: Specify next entry used in profile

Explanation: To set action of an entry for a specific IPMC profile.

Negation: (config-ipmc-profile)# no range <entry_name>

Show: # show ipmc profile
#show ipmc profile [<profile_name>] [detail]

3.9.19 (config)# ipv6

3.9.19.1 (config)# ipv6 dhcp snooping

Syntax: (config)# ipv6 dhcp snooping

Explanation: Enable IPv6 DHCP Snooping mode. When DHCPv6 snooping mode operation is enabled, the DHCPv6 client request messages will be forwarded to trusted ports and only allow reply packets from trusted ports.

Negation: (config)# no ipv6 dhcp snooping

Show: > show ipv6 dhcp snooping
show ipv6 dhcp snooping

3.9.19.2 (config)# ipv6 dhcp snooping uh-unknown

Syntax: (config)# ipv6 dhcp snooping nh-unknown {drop | allow}

Explanation: Specify how unknown IPv6 "next-header" values should be treated. The switch needs to parse all IPv6 packets to a DHCPv6 client to determine if it is in fact a DHCPv6 message. If an unknown IPv6 extension header is encountered the parsing cannot continue. See RFC 7610, section 5, item 3 for details.

Parameters:

{drop | allow}: Two options are available for this command:

Drop: Drop packets with unknown IPv6 extension headers. This is the most secure option but may result in traffic disruptions.

Allow: Allow packets with unknown IPv6 extension headers. This is a less secure option but prevents traffic disruptions.

Show: > show ipv6 dhcp snooping
show ipv6 dhcp snooping

3.9.19.3 (config)# ipv6 mld host-proxy

Syntax: (config)# ipv6 mld host-proxy

Explanation: Enable IPv6 MLD proxy. When MLD proxy is enabled, the switch exchanges MLD messages with the router on its upstream interface, and performs the host portion of the MLD task on the upstream interface as follows:

- When queried, it sends multicast listener reports to the group.
- When a host joins a multicast group to which no other host belongs, it sends unsolicited multicast listener reports to that group.
- When the last host in a particular multicast group leaves, it sends an unsolicited multicast listener done report to the all-routers address (FF02::2) for MLDv1.

Example: Enable IPv6 MLD Proxy.

```
# config t
(config)# ipv6 mld host-proxy
(config)#
```

Negation: (config)# no ipv6 mld host-proxy

Show: > show ipv6 mld snooping [vlan <v_vlan_list>] [group-database [interface (<port_type> [<v_port_type_list>)]] [sfm-information]] [detail]
show ipv6 mld snooping [vlan <v_vlan_list>] [group-database [interface (<port_type> [<v_port_type_list>)]] [sfm-information]] [detail]

3.9.19.4 (config)# ipv6 mld host-proxy leave-proxy

Syntax: (config)# ipv6 mld host-proxy leave-proxy

Explanation: Enable IPv6 MLD leave proxy. To prevent multicast router from becoming overloaded with leave messages, MLD snooping suppresses leave messages unless received from the last member port in the group. When the switch acts as the querier, the leave proxy feature will not function.

Example: Enable IPv6 MLD leave proxy.

```
# config t
(config)# ipv6 mld host-proxy leave-proxy
(config)#
```

Negation: (config)# no ipv6 mld host-proxy leave-proxy

Show: > show ipv6 mld snooping [vlan <v_vlan_list>] [group-database [interface (<port_type> [<v_port_type_list>])] [sfm-information]] [detail]
show ipv6 mld snooping [vlan <v_vlan_list>] [group-database [interface (<port_type> [<v_port_type_list>])] [sfm-information]] [detail]

3.9.19.5 (config)# ipv6 mld snooping

Syntax: (config)# ipv6 mld snooping

Explanation: Enable MLD Snooping feature globally. When enabled, this device will monitor network traffic and determine which hosts would like to receive multicast traffic. The switch can passively monitor or snoop on MLD Listener Query and Report packets transferred between IP multicast routers and IP multicast service subscribers to identify the multicast group members. The switch simply monitors the IGMP packets passing through it, picks out the group registration information and configures the multicast filters accordingly.

Example: Enable IPv6 MLD snooping.

```
# config t
(config)# ipv6 mld snooping
(config)#
```

Negation: (config)# no ipv6 mld snooping

Show: > show ipv6 mld snooping [vlan <v_vlan_list>] [group-database [interface (<port_type> [<v_port_type_list>])] [sfm-information]] [detail]
show ipv6 mld snooping [vlan <v_vlan_list>] [group-database [interface (<port_type> [<v_port_type_list>])] [sfm-information]] [detail]

3.9.19.6 (config)# ipv6 mld snooping vlan

Syntax: (config)# ipv6 mld snooping vlan <v_vlan_list>

Parameters:

<v_vlan_list>: Specify VLAN ID for MLD.

Negation: (config)# no ipv6 mld snooping vlan [<v_vlan_list>]

Show: > show ipv6 mld snooping [vlan <v_vlan_list>] [group-database [interface (<port_type> [<v_port_type_list>])] [sfm-information]] [detail]
> show ipv6 mld snooping mrouter [detail]
show ipv6 mld snooping [vlan <v_vlan_list>] [group-database [interface (<port_type> [<v_port_type_list>])] [sfm-information]] [detail]
show ipv6 mld snooping mrouter [detail]

Clear: # clear ipv6 mld snooping [vlan <v_vlan_list>] statistics

3.9.19.7 (config)# ipv6 mld ssm-range

Syntax: (config)# ipv6 mld ssm-range <v_ipv6_mcast> <ipv6_prefix_length>

Parameters:

<v_ipv6_mcast>: Specify valid IPv6 mluticast address.

<ipv6_prefix_length>: Specify prefix length range from 8 to 128.

Explanation: Specify SSM (Source-Specific Multicast) Range. This setting allows the SSM-aware hosts and routers run the SSM service model for the groups in the address range.

Example: Configure MLD SSM with the ff3e::7728/128 settings.

```
# config t
(config)# ipv6 mld ssm-range ff3e::7728 128
```

Negation: (config)# no ipv6 mld ssm-range

Show: > show ipv6 mld snooping [vlan <v_vlan_list>] [group-database [interface (<port_type> [<v_port_type_list>])] [sfm-information]] [detail]
show ipv6 mld snooping [vlan <v_vlan_list>] [group-database [interface (<port_type> [<v_port_type_list>])] [sfm-information]] [detail]

3.9.19.8 (config)# ipv6 mld unknown-flooding

Syntax: (config)# ipv6 mld unknown-flooding

Explanation: Enable forwarding mode for unregistered (not-joined) IP multicast traffic.

Example: To flood unregistered IPv6 multicast traffic

```
# config t
(config)# ipv6 mld unknown-flooding
```

Negation: (config)# no ipv6 mld unknown-flooding

Show: > show ipv6 mld snooping [vlan <v_vlan_list>] [group-database [interface (<port_type> [<v_port_type_list>])] [sfm-information]] [detail]
> show ipv6 mld snooping mrouter [detail]
show ipv6 mld snooping [vlan <v_vlan_list>] [group-database [interface (<port_type> [<v_port_type_list>])] [sfm-information]] [detail]
show ipv6 mld snooping mrouter [detail]

3.9.19.9 (config)# ipv6 route

Syntax: (configure)# ipv6 route <v_ipv6_subnet> { <v_ipv6_ucast> | interface vlan <v_vlan_id> <v_ipv6_addr> }

Parameters:

<v_ipv6_subnet>: Specify IPv6 route address.

{ <v_ipv6_ucast> | interface vlan <v_vlan_id> <v_ipv6_addr> }: Specify one of the options. This could be either IPv6 next hop unicast address or an interface.

Explanation: Configure a static IPv6 route.

Negation: (config)# no ipv6 route <v_ipv6_subnet> { <v_ipv6_ucast> | interface vlan <v_vlan_id> <v_ipv6_addr> }

Show: # show ipv6 route [interface vlan <v_vlan_list>]

3.9.19.10 (config)# ipv6 source binding interface

Syntax: (configure)# ipv6 source binding interface <port_type> <port_type_id> [vlan <vlan_id>] <ipv6_ucast> <mac_ucast>

Explanation: Create a static IPv6 entry.

Parameters:

<port_type> <in_port_type_id>: Specify a port type and port number to which a static entry is bound.

<vlan_var>: Specify VLAN ID that has been configured.

<ipv6_ucast>: Specify a valid IPv6 address.

<mac_ucast>: Specify the MAC address for this entry.

Negation: (config)# no ipv6 source binding interface <port_type> <port_type_id> [vlan <vlan_id>] <ipv6_ucast> <mac_ucast>

Show: # show ipv6 source binding [dhcpv6-snooping | static] [interface (<port_type> [<port_list>])]

3.9.20 (config)# lacp system-priority

Syntax: (configure)# lacp system-priority <v_1_to_65535>

Parameters:

<v_1_to_65535>: The priority of the port. The allowed value range is from 1 to 65535.

Explanation: Configure system priority for LACP function. The lower number means greater priority. This priority value controls which ports will be active and which ones will be in a backup role.

Example: Set LACP system priority value to 100.

```
# config t
(config)# lacp system-priority 100
```

Negation: (config)# no lacp system-priority <v_1_to_65535>

Show: # show lacp { internal | statistics | system-id | neighbour }

3.9.21 (config)# line

3.9.21.1 (config)# line

Syntax: (configure)# line { <0~16> | console 0 | vty <0~15> }

Explanation: Enter the specific line. When Enter is pressed, the command line changes to "(config-line)#".

Parameters:

{ <0~16> | console 0 | vty <0~15> }: Specify one of the options.

<0~16> : List of line numbers.

console 0: Console line connection.

vtty <0~15>: VTY lines are the Virtual Terminal lines of the device, used solely to control inbound Telnet connections. They are virtual, in the sense that they are a function of software - there is no hardware associated with them.

Example: Enter Console 0 mode.

```
# config t
(config)# line console 0
(config-line)#
```

Show: > show line [alive]
show line [alive]

3.9.21.2 (config-line)# do

Syntax: (config-line)# do <command>

Explanation: To run EXEC. commands.

Parameters:

<command>: Enter the EXEC. command

Example: Show aaa settings.

```
# config t
(config)# line console 0
(config-line)# do show aaa
console : local
telnet  : local
ssh     : local
http   : local
(config-line)#
```

3.9.21.3 (config-line)# editing

Syntax: (config-line)# editing

Explanation: Enable command line editing.

Negation: (config-line)# no editing

Show: > show line [alive]
show line [alive]

3.9.21.4 (config-line)# end

Syntax: (config-line)# end

Explanation: Return to EXEC. mode.

Example: Return to EXEC. mode.

```
# config t
(config)# line console 0
(config-line)# end
#
```

3.9.21.5 (config-line)# exec-banner

Syntax: (config-line)# exec-banner

Explanation: Enable the display of EXEC banner.

Example: Enable the display of EXEC banner.

```
# config t
(config)# line console 0
(config-line)# exec-banner
```

Negation: (config-line)# no exec-banner

Show: > show line [alive]
show line [alive]

3.9.21.6 (config-line)# exec-timeout

Syntax: (config-line)# exec-timeout <min> [<sec>]

Parameters:

<min>: Specify timeout in minutes. The allowed range is 0 to 1440.

[<sec>]: Specify timeout in seconds. The allowed range is 0 to 3600.

Negation: (config-line)# no exec-timeout

Show: > show line [alive]
show line [alive]

3.9.21.7 (config-line)# exit

Syntax: (config-line)# exit

Explanation: Return to Config mode.

Example: Return to Config mode.

```
# config t
(config)# line console 0
(config-line)# exit
(config)#
```

3.9.21.8 (config-line)# help

Syntax: (config-line)# help

Explanation: Show the Help explanation.

Example: Show Help explanation.

```
# config t
(config)# line console 0
(config-line)# help
Help may be requested at any point in a command by entering
a question mark '?'. If nothing matches, the help list will
be empty and you must backup until entering a '?' shows the
available options.
Two styles of help are provided:
1. Full help is available when you are ready to enter a
   command argument (e.g. 'show ?') and describes each possible
   argument.
2. Partial help is provided when an abbreviated argument is entered
   and you want to know what Parameters match the input
   (e.g. 'show pr?'.)
```

3.9.21.9 (config-line)# history size

Syntax: (config-line)# history size <history_size>

Explanation: Control how many history commands are displayed.

Parameters:

<history_size>: The allowed range is 0 to 32. 0 means “disable”.

Example: Set history size to 10.

```
# config t
(config)# line console 0
(config-line)# history size 10
```

Negation: (config-line)# no history size

Show: > show line [alive]
show line [alive]

3.9.21.10 (config-line)# length

Syntax: (config-line)# length <length>

Explanation: Configure the number of lines displayed on the screen.

Parameters:

<length>: Specify the number of lines displayed on the screen. The allowed range is 3 to 512. Specify "0" for no pausing.

Example: Display 20 lines on the screen.

```
# config t
(config)# line console 0
(config-line)# length 20
(config-line)#
```

Negation: (config-line)# no length

Show: > show line [alive]
show line [alive]

3.9.21.11 (config-line)# location

Syntax: (config-line)# location <location>

Explanation: Configure the descriptive location of this device.

Parameters:

<location>: Location description for the terminal. The characters allowed are 32.

Example: Configure the location "cabinet5a".

```
# config t
(config)# line console 0
(config-line)# location cabinet5a
(config-line)#
```

Negation: (config-line)# no location

Show: > show line [alive]
show line [alive]

3.9.21.12 (config-line)# motd-banner

Syntax: (config-line)# motd-banner

Explanation: Enable the display of motd (message of the day) banner.

Example: Enable motd banner.

```
# config t
(config)# line console 0
(config-line)# motd-banner
(config-line)#
```

Negation: (config-line)# no motd-banner

Show: > show line [alive]
show line [alive]

3.9.21.13 (config-line)# privilege level

Syntax: (config-line)# privilege level <privileged_level>

Explanation: Configure the privilege level for the terminal line.

Parameters:

<privileged_level>: Privilege level for the terminal line. The allowed range is 0 to 15.

Example: Change the privilege level to 5 for vty 1.

```
# config t
(config)# line vty 1
(config-line)# privilege level 5
(config-line)#
```

Negation: (config-line)# no privilege level

Show: > show line [alive]
show line [alive]

3.9.21.14 (config-line)# width

Syntax: (config-line)# width <width>

Explanation: Configure the width of the terminal line.

Parameters:

<width>: Specify the width of the terminal line. The allowed range is 40 to 512. Specify "0" for unlimited width.

Example: Change of width of vty 1 to 60.

```
# config t
(config)# line vty 1
(config-line)# width 60
(config-line)#
```

Negation: (config-line)# no width

Show: > show line [alive]
show line [alive]

3.9.22 (config)# lldp

3.9.22.1 (config)# lldp holdtime

Syntax: (config)# lldp holdtime <val>

Explanation: This setting defines how long LLDP frames are considered valid and is used to compute the TTL. The default is 4.

Parameters:

<val>: Specify the holdtime value. The allowed value is 2 to 10.

Example: Set the holdtime to 5.

```
# config t
(config)# lldp holdtime 5
```

Negation: (config)# no lldp holdtime

3.9.22.2 (config)# lldp reinit

Syntax: (config)# lldp reinit <val>

Explanation: Configure a delay between the shutdown frame and a new LLDP initialization.

Parameters:

<val>: Specify a value between 1 and 10 (seconds).

Example: Set the LLDP re-initiation value to 3.

```
# config t
(config)# lldp reinit 3
```

Negation: (config)# no lldp reinit

3.9.22.3 (config)# lldp timer

Syntax: (config)# lldp timer <val>

Explanation: Configure the interval between LLDP frames are sent to its neighbors for updated discovery information. The default is 30 seconds.

Parameters:

<val>: Specify a value between 5 and 32768 (seconds).

Example: Set the LLDP timer value to 35.

```
# config t
(config)# lldp timer 35
```

Negation: (config)# no lldp timer

3.9.22.4 (config)# lldp transmission-delay

Syntax: (config)# lldp transmission-delay <val>

Parameters:

<val>: Specify a value between 1 and 8192 (seconds).

Explanation: Configure a delay between the LLDP frames that contain changed configurations. Tx Delay cannot be larger than 1/4 of the Tx interval value.

Example: Set the LLDP transmission delay value to 2.

```
# config t
(config)# lldp transmission-delay 2
```

Negation: (config)# no lldp transmission-delay

3.9.22.5 (config)# lldp med datum

Syntax: (config)# lldp med datum { wgs84 | nad83-navd88 | nad83-mlw }

Explanation: The Map Datum is used for the coordinates given in above options.

Parameters:

{ wgs84 | nad83-navd88 | nad83-mlw }: Specify one of the options.

WGS84: (Geographical 3D) - World Geodesic System 1984, CRS Code 4327, Prime Meridian Name: Greenwich.

NAD83/NAVD88: North American Datum 1983, CRS Code 4269, Prime Meridian Name: Greenwich; The associated vertical datum is the North American Vertical Datum of 1988 (NAVD88). This datum pair is to be used when referencing locations on land, not near tidal water (which would use Datum = NAD83/MLLW).

NAD83/MLLW: North American Datum 1983, CRS Code 4269, Prime Meridian Name: Greenwich; The associated vertical datum is Mean Lower Low Water (MLLW). This datum pair is to be used when referencing locations on water/sea/ocean.

Example: Set the map datum to wgs84.

```
# config t
(config)# lldp med datum wgs84
```

Negation: (config)# no lldp med datum

3.9.22.6 (config)# lldp med fast

Syntax: (config)# lldp med fast <v_1_to_10>

Explanation: Rapid startup and Emergency Call Service Location Identification Discovery of endpoints is a critically important aspect of VoIP systems in general. In addition, it is best to advertise only those pieces of information which are specifically relevant to particular endpoint types (for example only advertise the voice network policy to permitted voice-capable devices), both in order to conserve the limited LLDPDU space and to reduce security and system integrity issues that can come with inappropriate knowledge of the network policy. With this in mind, LLDP-MED defines an LLDP-MED Fast Start interaction between the protocol and the application layers on top of the protocol, in order to achieve these related properties. With Fast start repeat count it is possible to specify the number of times the fast start transmission is repeated. The recommended value is 4 times, giving that 4 LLDP frames with a 1 second interval will be transmitted, when a LLDP frame with new information is received. It should be noted that LLDP-MED and the LLDP-MED Fast Start mechanism is only intended to run on links between LLDP-MED Network Connectivity Devices and Endpoint Devices, and as such does not apply to links between LAN infrastructure elements, including between Network Connectivity Devices, or to other types of links.

Parameters:

<v_1_to_10>: Specify a valid value between 1 and 10.

Example: Set the value to 5.

```
# config t
(config)# lldp med fast 5
```

Negation: (config)# no lldp med fast

3.9.22.7 (config)# lldp med location-tlv altitude

Syntax: (config)# lldp med location-tlv altitude { meters | floors } <v_word11>

Explanation: Altitude SHOULD be normalized to within -32767 to 32767 with a maximum of 4 digits. It is possible to select between two altitude types (floors or meters). “meters” means meters of Altitude defined by the vertical datum specified; while, “floors” means altitude in a form more relevant in buildings which have different floor-to-floor dimensions.

Parameters:

{ meters | floors }: Specify one of the options.

<v_word11>: Specify a value for the specified option.

Example: Set the altitude value to “floors 10”.

```
# config t
(config)# lldp med location-tlv altitude floors 10
```

Negation: (config)# no lldp med location-tlv altitude

3.9.22.8 (config)# lldp med location-tlv civic-addr

Syntax: (config)# lldp med location-tlv civic-addr { country | state | county | city | district | block | street | leading-street-direction | trailing-street-suffix | street-suffix | house-no | house-no-suffix | landmark | additional-info | name | zip-code | building | apartment | floor | room-number | place-type | postal-community-name | p-o-box | additional-code } <v_string250>

Explanation: Configure civic address information.

Parameters:

{ country | state | county | city | district | block | street | leading-street-direction | trailing-street-suffix | street-suffix | house-no | house-no-suffix | landmark | additional-info | name | zip-code | building | apartment | floor | room-number | place-type | postal-community-name | p-o-box | additional-code }; Specify one of the options.

country: The two-letter ISO 3166 country code in capital ASCII letters - Example: DK, DE or US.

state: National subdivisions (state, canton, region, province, prefecture).

county: County, parish, gun (Japan), district.

city: City, township, shi (Japan) - Example: Copenhagen.

district: City division, borough, city district, ward, chou (Japan).

block: Neighbourhood, block.

street: Street - Example: Poppelvej.

leading-street-direction: Example: N.

trailings-street-suffix: Example: SW.

street-suffix: Ave, Platz.

house-no: Specify house number.

house-no-suffix: Example: A, 1/2.

landmark: Landmark or vanity address - Example: Columbia University.

additional-info: Example: South Wing.

Name: Example: Flemming Jahn.

zip-code: Postal/zip code - Example: 2791.

building: Building (structure). Example: Low Library.

apartment: Unit (Apartment, suite). Example: Apt 42.

floor: Example: 4.

room-number: Room number - Example: 450F.

place-type: Example: Office.

postal-community-name: Example: Leonia.

p-o-box: Example: 12345.

additional code: Example: 1320300003.

Example: Set the country code to “UK”.

```
# config t
(config)# lldp med location-tlv civic-addr country UK
```

Negation: (config)# no lldp med location-tlv civic-addr { country | state | county | city | district | block | street | leading-street-direction | trailing-street-suffix | street-suffix | house-no | house-no-suffix | landmark | additional-info | name | zip-code | building | apartment | floor | room-number | place-type | postal-community-name | p-o-box | additional-code }

3.9.22.9 (config)# lldp med location-tlv elin-addr

Syntax: (config)# lldp med location-tlv elin-addr <v_word25>

Explanation: Configure a value for Emergency Location Information.

Parameters:

<v_word25>: A value for Emergency Location Information (ELIN).

Example: Set the emergency location information to “911”.

```
# config t
(config)# lldp med location-tlv elin-addr 911
```

Negation: (config)# no lldp med location-tlv elin-addr

3.9.22.10 (config)# lldp med location-tlv latitude

Syntax: (config)# lldp med location-tlv latitude { north | south } <v_word8>

Explanation: Configure a value for latitude. Latitude value should be between 0 and 90.

Parameters:

{ north | south }: Specify one of the options, either north or south.

<v_word8>: Specify latitude value for the selected option.

Example: Set the north latitude to 5.

```
# config t
(config)# lldp med location-tlv latitude north 5
```

Negation: (config)# no lldp med location-tlv latitude

3.9.22.11 (config)# lldp med location-tlv longitude

Syntax: (config)# lldp med location-tlv longitude { west | east } <v_word9>

Explanation: Configure a value for longitude. Longitude value should be between 0 and 180.

Parameters:

{ west | east }: Specify one of the options, either west or east.

<v_word9>: Specify longitude value for the selected option.

Example: Set the west longitude to 90.

```
# config t
(config)# lldp med location-tlv longitude west 90
```

Negation: (config)# no lldp med location-tlv longitude

3.9.22.12 (config)# lldp med media-vlan-policy

Syntax: (config)# lldp med media-vlan-policy <policy_index> { voice | voice-signaling | guest-voice-signaling | guest-voice | softphone-voice | video-conferencing | streaming-video | video-signaling } { tagged <v_vlan_id> | untagged } [l2-priority <v_0_to_7>] [dscp <v_0_to_63>]

Explanation: Configure a LLDP MED policy ID for a service.

Parameters:

<policy_index>: Specify a policy ID. The valid range is from 0 to 31.

{ voice | voice-signaling | guest-voice-signaling | guest-voice | softphone-voice | video-conferencing | streaming-video | video-signaling }: Specify one of the services for this policy ID.

{ tagged <v_vlan_id> | untagged }: Specify whether this service is tagged or untagged. When “tagged” is specified, a VLAN ID should be provided.

[l2-priority <v_0_to_7>]: Specify a value for L2 priority. The valid value is from 0 to 7.

[dscp <v_0_to_63>]: Specify a value for DSCP. The valid value is from 0 to 63.

Example: Create a policy ID 1 for tagged Voice VLAN.

```
# config t
(config)# lldp med media-vlan-policy 1 voice tagged 100 l2-priority 7 DSCP 63
```

Negation: (config)# no lldp med media-vlan-policy <policies_list>

Show: > show lldp med media-vlan-policy [<v_0_to_31>]
show lldp med media-vlan-policy [<v_0_to_31>]

3.9.23 (config)# logging

3.9.23.1 (config)# logging on

Syntax: (config)# logging on

Explanation: This sets the server mode operation. When the mode of operation is enabled (on), the syslog message will send out to syslog server (at the server address). The syslog protocol is based on UDP communication and received on UDP port 514. Syslog server will not send acknowledgments back to the sender since UDP is a connectionless protocol and it does not provide acknowledgments. The syslog packet will always send out, even if the syslog server does not exist. When the mode of operation is disabled, no syslog packets are sent out.

Example: Enable log server operation.

```
# config t
(config)# logging on
```

Negation: (config)# no logging on

Show: # show logging

Clear: # clear logging [info] [warning] [error] [switch <switch_list>]

3.9.23.2 (config)# logging host

Syntax: (config)# logging host { <v_ipv4_ucast> | <v_word45> }

Parameters:

{ <hostname> | <ipv4_ucast> }: Specify one of the options. The hostname is the domain name of the log server; while the latter is IPv4 address of the log server.

Explanation: Configure log server address.

Example: Use IPv4 address to configure log server.

```
# config t
(config)# logging host 192.168.1.253
```

Negation: (config)# no logging host

Show: # show logging

show logging <logging_id: 1-4294967295>

show logging [info] [warning] [error]

3.9.23.3 (config)# logging level

Syntax: (config)# logging level { info | warning | error }

Explanation: Configure what kind of messages will send to syslog server.

Parameters:

{ informational | warning | error }: Specify one of the log message options.

Informational: Send information, warnings and errors.

Warning: Send warnings and errors.

Error: Send errors only.

Example: Send error messages to log server.

```
# config t
(config)# logging level error
```

Show: # show logging
show logging <logging_id: 1-4294967295>
show logging [info] [warning] [error]

3.9.24 (config)# loop-protect

3.9.24.1 (config)# loop-protect

Syntax: (config)# loop-protect

Explanation: Enable loop protection function.

Example: Enable loop protection function.

```
# config t
(config)# loop-protect
```

Negation: (config)# no loop-protect

Show: # show loop-protect [interface (<port_type> [<plist>])]

3.9.24.2 (config)# loop-protect shutdown-time

Syntax: (config)# loop-protect shutdown-time <t>

Explanation: Configure the period for which a port will be kept disabled.

Parameters:

<t: 0-604800>: Specify a shutdown time value. The valid values are from 0 to 604800 seconds. 0 means that a port is kept disabled until next device restart.

Example: Set the shutdown time value to 180 seconds.

```
# config t
(config)# loop-protect shutdown-time 180
```

Negation: (config)# no loop-protect shutdown-time

Show: # show loop-protect [interface (<port_type> [<plist>])]

3.9.24.3 (config)# loop-protect transmit-time

Syntax: (config)# loop-protect transmit-time <t>

Explanation: Configure the interval between each loop protection PDU sent on each port.

Parameters:

<t: 1-10>: Specify a transmit time value. The valid values are from 1 to 10 seconds.

Example: Set the transmit time value to 5 seconds.

```
# config t
(config)# loop-protect transmit-time 5
```

Negation: (config)# no loop-protect transmit-time

Show: # show loop-protect [interface (<port_type> [<plist>])]

3.9.25 (config)# mac

3.9.25.1 (config)# mac address-table aging-time

Syntax: (config)# mac address-table aging-time <v_0_10_to_1000000>

Explanation: Configure the aging time for a learned MAC to be appeared in MAC learning table.

Parameters:

<v_0_10_to_1000000>: Specify an aging time value for MAC address table. The valid values are from 10 to 1000000 (seconds). Using "0" to disable aging time function.

Example: Set the aging time to 600 seconds.

```
# config t
(config)# mac address-table aging-time 600
```

Negation: (config)# no mac address-table aging-time

(config)# no mac address-table aging-time <v_0_10_to_1000000>

Show: > show mac address-table [conf | static | aging-time | { { learning | count } [interface (<port_type> [<v_port_type_list>])] } | { address <v_mac_addr> [vlan <v_vlan_id>] } | vlan <v_vlan_id_1> | interface (<port_type> [<v_port_type_list_1>])]]
 # show mac address-table [conf | static | aging-time | { { learning | count } [interface (<port_type> [<v_port_type_list>])] } | { address <v_mac_addr> [vlan <v_vlan_id>] } | vlan <v_vlan_id_1> | interface (<port_type> [<v_port_type_list_1>])]]
 # show mac address-table aging-time

3.9.25.2 (config)# mac address-table learning vlan

Syntax: (config)# mac address-table learning vlan <vlan_list>

Explanation: Configure VLANs that can learnt. MAC addresses from the specified VLANs will be learnts.

Parameters:

<vlan_list>: Specify the VLANs that can learn MAC addresses. By default, the list is empty. More VLANs can be created into the list. The following example will learn MAC addresses form VLANs 1, 10, 11, 12, 13, 200 and 300: 1, 10-13, 200, 300.

Negation: (config)# no mac address-table learning vlan <vlan_list>

NOTE: Issuing the negation command will restrict MAC addresses to be learnt from the specified VLANs.

Show: > show mac address-table [conf | static | aging-time | { { learning | count } [interface (<port_type> [<v_port_type_list>])] } | { address <v_mac_addr> [vlan <v_vlan_id>] } | vlan <v_vlan_id_1> | interface (<port_type> [<v_port_type_list_1>])]]
 # show mac address-table [conf | static | aging-time | { { learning | count } [interface (<port_type> [<v_port_type_list>])] } | { address <v_mac_addr> [vlan <v_vlan_id>] } | vlan <v_vlan_id_1> | interface (<port_type> [<v_port_type_list_1>])]]

3.9.25.3 (config)# mac address-table static

Syntax: (config)# mac address-table static <v_mac_addr> vlan <v_vlan_id> interface (<port_type> [<v_port_type_list>])

Explanation: Configure the static MAC address mapping table.

Parameters:

<v_mac_addr>: Specify MAC address in “xx:xx:xx:xx:xx:xx” format.

vlan <v_vlan_id>: Specify the VLAN ID for this entry.

interface (<port_type> [<v_port_type_list>]): Specify the interface port type and the port number.

Example: Add a static MAC address “11:11:22:22:33:33” to MAC address table.

```
# config t
(config)# mac address-table static 11:11:22:22:33:33 vlan 1 interface
GigabitEthernet 1/1-10
```

Negation: (config)# no mac address-table static <v_mac_addr> vlan <v_vlan_id> interface (<port_type> [<v_port_type_list>])

Show: > show mac address-table [conf | static | aging-time | { { learning | count } [interface (<port_type> [<v_port_type_list>])] } | { address <v_mac_addr> [vlan <v_vlan_id>] } | vlan <v_vlan_id_1> | interface (<port_type> [<v_port_type_list_1>])]]
show mac address-table [conf | static | aging-time | { { learning | count } [interface (<port_type> [<v_port_type_list>])] } | { address <v_mac_addr> [vlan <v_vlan_id>] } | vlan <v_vlan_id_1> | interface (<port_type> [<v_port_type_list_1>])]]

Clear: # clear mac address-table

3.9.26 (config)# monitor session

Syntax: (config)# monitor session <session_number> [destination { interface (<port_type> [<di_list>]) | remote vlan <drvid> reflector-port <port_type> <rportid> } | source { interface (<port_type> [<si_list>]) [both | rx | tx] | remote vlan <srvid> | vlan <source_vlan_list> | cpu [both | rx | tx] }]

Explanation: Configure which port traffic should be mirrored to.

Parameters:

<session_number <1-5>: Specify a session number (1 to 5) to this entry.

[destination { interface (<port_type> [<di_list>]) | remote vlan <drvid> reflector-port <port_type> <rportid> } | source { interface (<port_type> [<si_list>]) [both | rx | tx] | remote vlan <srvid> | vlan <source_vlan_list> | cpu [both | rx | tx] }]: Specify the mirroring source.

Negation: (config)# no monitor session <session_number> [destination { interface (<port_type> [<di_list>]) | remote vlan <drvid> reflector-port <port_type> <rportid> } | source { interface (<port_type> [<si_list>]) [both | rx | tx] | remote vlan <srvid> | vlan <source_vlan_list> | cpu [both | rx | tx] }]

Show: show monitor [session { <session_number> | all | remote }]

3.9.27 (config)# mvr

3.9.27.1 (config)# mvr

Syntax: (config)# mvr

Explanation: Enable MVR function.

Example: Enable MVR function.

```
# config t
(config)# mvr
```

Negation: (config)# no mvr

Show: > show mvr
show mvr

3.9.27.2 (config)# mvr name <mvr_name> channel

Syntax: (config)# mvr name <mvr_name> channel <profile_name>

Explanation: Configure MVR name and channel.

Parameters:

<mvr_name>: Specify a name for this MVR entry. The allowed characters are 16.

<profile_name>: Specify a channel name for this MVR entry. The allowed characters are 16.

Example: Set up a MVR entry “video1” and its corresponding channel profile name “1”.

```
# config t
(config)# mvr name video1 channel 1
```

Negation: (config)# no mvr name <mvr_name> channel

Show: > show mvr [vlan <v_vlan_list> | name <mvr_name>] [group-database [interface (<port_type> [<v_port_type_list>])] [sfm-information]] [detail]
show mvr [vlan <v_vlan_list> | name <mvr_name>] [group-database [interface (<port_type> [<v_port_type_list>])] [sfm-information]] [detail]

3.9.27.3 (config)# mvr name <mvr_name> frame priority

Syntax: (config)# mvr name <mvr_name> frame priority <cos_priority>

Explanation: Configure the priority for transmitting IGMP/MLD control frames for the specified MVR entry.

Parameters:

<mvr_name>: Specify a name for this MVR entry. The allowed characters are 16.

<cos_priority>: Specify a Cos priority for this MVR entry. The allowed range is from 0 to 7.

Example: Set up a MVR entry “video1” and its corresponding priority value “0”.

```
# config t
(config)# mvr name video1 frame priority 0
```

Negation: (config)# no mvr name <mvr_name> frame priority

Show: > show mvr [vlan <v_vlan_list> | name <mvr_name>] [group-database [interface (<port_type> [<v_port_type_list>])] [sfm-information]] [detail]
show mvr [vlan <v_vlan_list> | name <mvr_name>] [group-database [interface (<port_type> [<v_port_type_list>])] [sfm-information]] [detail]

3.9.27.4 (config)# mvr name <mvr_name> frame tagged

Syntax: (config)# mvr name <mvr_name> frame tagged

Explanation: Tagged IGMP/MLD frames will be sent.

Parameters:

<mvr_name>: Specify a name for this MVR entry. The allowed characters are 16.

Example: Set “video1” MVR entry to send tagged IGMP/MLD frames.

```
# config t
(config)# mvr name video1 frame tagged
```

Negation: (config)# no mvr name <mvr_name> frame tagged

Show: > show mvr [vlan <v_vlan_list> | name <mvr_name>] [group-database [interface (<port_type> [<v_port_type_list>])] [sfm-information]] [detail]
show mvr [vlan <v_vlan_list> | name <mvr_name>] [group-database [interface (<port_type> [<v_port_type_list>])] [sfm-information]] [detail]

3.9.27.5 (config)# mvr name <mvr_name> last-member-query-interval

Syntax: (config)# mvr name <mvr_name> last-member-query-interval <ipmc_lmqi>

Explanation: Configure the maximum time to wait for IGMP/MLD report memberships on a receiver port before removing the port from multicast group membership.

Parameters:

<mvr_name>: Specify a name for this MVR entry. The allowed characters are 16.

<ipmc_lmqi>: Specify the LMQI (Last Member Query Interval) value. By default, LMQI is set to 5 tenths of a second (0.5 second). The allowed range is from 0 to 31744 tenths of a second.

Example: Set LMQI value to 600 tenths of a second.

```
# config t
(config)# mvr name video1 last-member-query-interval 600
```

Negation: (config)# no mvr vlan <mvr_name> last-member-query-interval

Show: > show mvr [vlan <v_vlan_list> | name <mvr_name>] [group-database [interface (<port_type> [<v_port_type_list>])] [sfm-information]] [detail]
show mvr [vlan <v_vlan_list> | name <mvr_name>] [group-database [interface (<port_type> [<v_port_type_list>])] [sfm-information]] [detail]

3.9.27.6 (config)# mvr name <mvr_name> mode

Syntax: (config)# mvr name <mvr_name> mode { dynamic | compatible }

Explanation: Configure MVR mode.

Parameters:

<mvr_name>: Specify a name for this MVR entry. The allowed characters are 16.

{ dynamic | compatible }: Specify one of the options.

Dynamic: MVR allows dynamic MVR membership reports on source ports. (This is the default mode.)

Compatible: MVR membership reports are forbidden on source ports.

Example: Set MVR mode to dynamic.

```
# config t
(config)# mvr name video1 mode dynamic
```

Negation: (config)# no mvr name <mvr_name> mode

Show: > show mvr [vlan <v_vlan_list> | name <mvr_name>] [group-database [interface (<port_type> [<v_port_type_list>])] [sfm-information]] [detail]
show mvr [vlan <v_vlan_list> | name <mvr_name>] [group-database [interface (<port_type> [<v_port_type_list>])] [sfm-information]] [detail]

3.9.27.7 (config)# mvr vlan <v_vlan_list>

Syntax: (config)# mvr vlan <v_vlan_list> [name <mvr_name>]

Explanation: Configure a MVR VLAN and its corresponding MVR name.

Parameters:

<v_vlan_list>: Specify multicast VLAN ID.

[name <mvr_name>]: Specify a name for this MVR entry. This argument is optional.

Example: Set up MVR VLAN 201 and its corresponding name.

```
# config t
(config)# mvr vlan 201 video1
```

Negation: (config)# no mvr vlan <v_vlan_list>

Show: > show mvr [vlan <v_vlan_list> | name <mvr_name>] [group-database [interface (<port_type> [<v_port_type_list>])] [sfm-information]] [detail]
show mvr [vlan <v_vlan_list> | name <mvr_name>] [group-database [interface (<port_type> [<v_port_type_list>])] [sfm-information]] [detail]

3.9.27.8 (config)# mvr vlan <v_vlan_list> channel

Syntax: (config)# mvr vlan <v_vlan_list> channel <profile_name>

Explanation: Configure MVR name and channel.

Parameters:

<v_vlan_list>: Specify MVR VLAN ID for this entry.

<profile_name>: Specify a channel name for this MVR entry. The allowed characters are 16.

Example: Set up Set up MVR VLAN 201 and its corresponding channel.

```
# config t
(config)# mvr vlan 201 channel 1
```

Negation: (config)# no mvr vlan <v_vlan_list> channel

Show: > show mvr [vlan <v_vlan_list> | name <mvr_name>] [group-database [interface (<port_type> [<v_port_type_list>])] [sfm-information]] [detail]
show mvr [vlan <v_vlan_list> | name <mvr_name>] [group-database [interface (<port_type> [<v_port_type_list>])] [sfm-information]] [detail]

3.9.27.9 (config)# mvr vlan <v_vlan_list> frame priority

Syntax: (config)# mvr vlan <v_vlan_list> frame priority <cos_priority>

Explanation: Configure the priority for transmitting IGMP/MLD control frames for the specified MVR VLAN ID.

Parameters:

<v_vlan_list>: Specify MVR VLAN ID for this entry.

<cos_priority>: Specify a Cos priority for this MVR entry. The allowed range is from 0 to 7.

Example: Set up a MVR VLAN 201 and its corresponding priority value "0".

```
# config t
(config)# mvr vlan 201 frame priority 0
```

Negation: (config)# no mvr vlan <v_vlan_list> frame priority

Show: > show mvr [vlan <v_vlan_list> | name <mvr_name>] [group-database [interface (<port_type> [<v_port_type_list>])] [sfm-information]] [detail]
show mvr [vlan <v_vlan_list> | name <mvr_name>] [group-database [interface (<port_type> [<v_port_type_list>])] [sfm-information]] [detail]

3.9.27.10 (config)# mvr vlan <v_vlan_list> frame tagged

Syntax: (config)# mvr vlan <v_vlan_list> frame tagged

Explanation: Tagged IGMP/MLD frames will be sent.

Parameters:

<v_vlan_list>: Specify MVR VLAN ID for this entry.

Example: Set MVR VLAN 201 to send tagged IGMP/MLD frames.

```
# config t
(config)# mvr vlan 201 frame tagged
```

Negation: (config)# no mvr vlan <v_vlan_list> frame tagged

Show: > show mvr [vlan <v_vlan_list> | name <mvr_name>] [group-database [interface (<port_type> [<v_port_type_list>])] [sfm-information]] [detail]
show mvr [vlan <v_vlan_list> | name <mvr_name>] [group-database [interface (<port_type> [<v_port_type_list>])] [sfm-information]] [detail]

3.9.27.11 (config)# mvr vlan <v_vlan_list> last-member-query-interval

Syntax: (config)# mvr vlan <v_vlan_list> last-member-query-interval <ipmc_lmqi>

Explanation: Configure the maximum time to wait for IGMP/MLD report memberships on a receiver port before removing the port from multicast group membership.

Parameters:

<v_vlan_list>: Specify MVR VLAN ID for this entry.

<ipmc_lmqi>: Specify the LMQI (Last Member Query Interval) value. By default, LMQI is set to 5 tenths of a second (0.5 second). The allowed range is from 0 to 31744 tenths of a second.

Example: Set LMQI value to 600 tenths of a second.

```
# config t
(config)# mvr vlan 201 last-member-query-interval 600
```

Negation: (config)# no mvr vlan <v_vlan_list> last-member-query-interval

Show: > show mvr [vlan <v_vlan_list> | name <mvr_name>] [group-database [interface (<port_type> [<v_port_type_list>])] [sfm-information]] [detail]
show mvr [vlan <v_vlan_list> | name <mvr_name>] [group-database [interface (<port_type> [<v_port_type_list>])] [sfm-information]] [detail]

3.9.27.12 (config)# mvr vlan <v_vlan_list> mode

Syntax: (config)# mvr vlan <v_vlan_list> mode { dynamic | compatible }

Explanation: Configure MVR mode.

Parameters:

<v_vlan_list>: Specify MVR VLAN ID for this entry.

{ dynamic | compatible }: Specify one of the options.

Dynamic: MVR allows dynamic MVR membership reports on source ports. (This is the default mode.)

Compatible: MVR membership reports are forbidden on source ports.

Example: Set MVR mode to dynamic.

```
# config t
(config)# mvr vlan 201 mode dynamic
```

Negation: (config)# no mvr vlan <v_vlan_list> mode

Show: > show mvr [vlan <v_vlan_list> | name <mvr_name>] [group-database [interface (<port_type> [<v_port_type_list>])] [sfm-information]] [detail]
show mvr [vlan <v_vlan_list> | name <mvr_name>] [group-database [interface (<port_type> [<v_port_type_list>])] [sfm-information]] [detail]

3.9.27.13 (config)# mvr vlan <v_vlan_list> { election | igmp-address <v_ipv4_ucast> }

Syntax: (config)# mvr vlan <v_vlan_list> { election | igmp-address <v_ipv4_ucast> }

Explanation: Enable to join IGMP Querier election in the VLAN or specify IGMP Querier IPv4 address.

Parameters:

<v_vlan_list>: Specify MVR VLAN ID for this entry.

{ election | igmp-address <v_ipv4_ucast> }: Specify one of the options.

election: Enable to join IGMP Querier election in the VLAN.

igmp-address <v_ipv4_ucast>: Specify IGMP Querier IPv4 address.

Negation: (config)# no mvr vlan <v_vlan_list> { election | igmp-address }

Show: > show mvr [vlan <v_vlan_list> | name <mvr_name>] [group-database [interface (<port_type> [<v_port_type_list>])] [sfm-information]] [detail]
show mvr [vlan <v_vlan_list> | name <mvr_name>] [group-database [interface (<port_type> [<v_port_type_list>])] [sfm-information]] [detail]

3.9.28 (config)# ntp

3.9.28.1 (config)# ntp

Syntax: (config)# ntp

Explanation: Enable NTP function.

Example: Enable NTP function.

```
# config t
(config)# ntp
```

Negation: (config)# no ntp

Show: # show ntp status

3.9.28.2 (config)# ntp server

Syntax: (config)# ntp server <index_var> ip-address { <ipv4_var> | <ipv6_var> | <name_var> }

Explanation: Configure a list of NTP server's address.

Parameters:

< index_var: 1-5>: Specify the index number of NTP server. The allowed range is from 1 to 5. The NTP servers are tried in numeric order. If 'Server 1' is unavailable, the NTP client will try to contact 'Server 2'.

{ <ipv4_var> | <ipv6_var> | <name_var> }: Specify one of the three options.

<ipv4_var>: IPv4 address.

<ipv6_var>: IPv6 address is in 128-bit records represented as eight fields of up to four hexadecimal digits with a colon separating each field (:). For example, 'fe80::215:c5ff:fe03:4dc7'. The symbol '::' is a special syntax that can be used as a shorthand way of representing multiple 16-bit groups of contiguous zeros; but it can appear only once.

<name_var>: The domain name for NTP server.

Example: Set the NTP server 1 to 192.168.1.253.

```
# config t
(config)# ntp server 1 ip-address 192.168.1.253
```

Negation: (config)# no ntp server <index_var>

Show: # show ntp status

3.9.29 (config)# poe (For PoE Models Only)

3.9.29.1 (config)# poe capacitor-detect

Syntax: (config)# poe capacitor-detect

Explanation: Enable capacitor detection function.

Negation: (config)# no poe capacitor-detect

3.9.29.2 (config)# poe supply

Syntax: (config)# poe supply <v_0_to_300>

Explanation: Configure the maximum power supply that the device can deliver.

Parameters:

<v_0_to_300>: Specify maximum power supply that the device can deliver.

Negation: (config)# no poe supply

3.9.29.3 (config)# poe management mode

Syntax: (config)# poe management mode { class-consumption | class-reserved-power | allocation-consumption | allocation-reserved-power | lldp-consumption | lldp-reserved-power }

Explanation: Power over Ethernet (PoE) commands are used to set the maximum PoE power provided to a port, the maximum power budget for the switch (power available to PoE-enabled RJ-45 ports), the port PoE operating mode, power allocation priority, and the maximum power allocated to each port. If the power demand from devices connected to the switch exceeds the power budget, the switch uses port power priority settings to limit the supplied power.

Parameters:

consumption & reserved power mode: “consumption” & “reserved-power” mode decide how ports are shut down.

consumption: When this mode is used, ports are shut down in the event of the following situations.

1. When the actual power consumption for all ports exceeds the amount of power supply can deliver.
2. When the actual power consumption for a given port exceeds the reserved power for that port.

Ports are shut down according to their port priority. If two ports have the same priority, the port with the higher port number is shut down.

reserved-power: When this mode is selected, ports are shut down when total reserved power exceeds the amount of power that the power supply can deliver. In this mode, if the PD (Powered Device) keeps requesting more power than available from the power supply, then the port power is not turned on.

class, allocation & lldp: These modes are used to set up how attached PD may reserve power:

class: Each port automatically determines how much power to reserve according to the class which the connected PD belongs. Four different port classes are used, these are 4, 7, 15.4 and 34.2 Watts.

allocation: The amount of power reserved for each is specified in “Maximum Power [W]” field.

lldp: This mode is similar to Class mode except that each port determines the amount power it reserves by exchanging PoE information using LLDP protocol and reserves power accordingly. If no LLDP information is available for a port, the port will reserve power using the Class mode.

NOTE: *If ports use more power than the power reserved for them, they will be shut down.*

Negation: (config)# no poe management mode

Show: > show poe [interface (<port_type> [<v_port_type_list>])]
show poe [interface (<port_type> [<v_port_type_list>])]

3.9.30 (config)# port-security

3.9.30.1 (config)# port-security

Syntax: (config)# port-security

Explanation: Enable port security function globally.

Example: Enable port security function globally.

```
# config t
(config)# port-security
```

Negation: (config)# no port-security

Show: > show port-security switch [interface (<port_type> [<v_port_type_list>])]
show port-security switch [interface (<port_type> [<v_port_type_list>])]

3.9.30.2 (config)# port-security aging

Syntax: (config)# port-security aging

Explanation: Enable port security aging function. If enabled, secured MAC addresses are subject to aging as discussed in “Aging time” command. With aging enabled, a timer is started once the end-host gets secured. When the timer expires, the switch starts looking for frames from the end-host, and if such frames are not seen within the next Aging Period, the end-host is assumed to be disconnected, and the corresponding resources are freed on the switch.

Example: Enable port security aging function.

```
# config t
(config)# port-security aging
```

Negation: (config)# no port-security aging

Show: > show port-security port [interface (<port_type> [<v_port_type_list>])]
show port-security port [interface (<port_type> [<v_port_type_list>])]

3.9.30.3 (config)# port-security aging time

Syntax: (config)# port-security aging time <v_10_to_10000000>

Explanation: Configure a desired aging time value. If “Aging” is enabled, secured MAC addresses are subject to aging as discussed this command. With aging enabled, a timer is started once the end-host gets secured. When the timer expires, the switch starts looking for frames from the end-host, and if such frames are not seen within the next Aging Period, the end-host is assumed to be disconnected, and the corresponding resources are freed on the switch.

Parameters:

<v_10_to_10000000>: Specify the aging time value. The allowed range is between 10 and 10,000,000 seconds.

Example: Set the aging time value to 1800 seconds.

```
# config t
(config)# port-security aging time 1800
```

Negation: (config)# no port-security aging time

Show: > show port-security port [interface (<port_type> [<v_port_type_list>])]
show port-security port [interface (<port_type> [<v_port_type_list>])]

3.9.30.4 (config)# port-security hold time

Syntax: (config)# port-security hold time <v_10_to_10000000>

Explanation: Configure a desired hold time value in seconds. This value is used to determine how long a MAC address is held in the MAC table if it has been found to violate the limit. The default value 300 seconds but can be changed to the desired value from 10 to 10000000 seconds. The reason for holding a violating MAC address in MAC table is primarily to ensure that the same MAC address doesn't give rise to continuous notifications (if notifications on violation count is enabled).

Parameters:

<v_10_to_10000000>: Specify the hold time value. The allowed range is between 10 and 10,000,000 seconds.

Negation: (config)# no port-security hold time

Show: > show port-security [interface (<port_type> [<v_port_type_list>])]
show port-security [interface (<port_type> [<plist>])]
show port-security address [interface (<port_type> [<plist>])]

3.9.31 (config)# privilege

Syntax: (config)# privilege { cfm-dmn | cfm-dmn-svc | cfm-dmn-svc-mep | config-vlan | configure | dhcp-pool | erps | exec | if-vlan | interface | ipmc-profile | line | llag | qos-map-egress | qos-map-ingress | snmps-host | stp-aggr } level <privilege> <cmd>

Explanation: This command is used to change the privilege level of commands available in Configuration mode.

Parameters:

{ cfm-dmn | cfm-dmn-svc | cfm-dmn-svc-mep | config-vlan | configure | dhcp-pool | erps | exec | if-vlan | interface | ipmc-profile | line | llag | qos-map-egress | qos-map-ingress | snmps-host | stp-aggr }: Specify the group command that you want to configure.

level <privilege>: Specify the privilege level. The allowed range is 0 to 15.

<cmd>: Initial valid words and literals of the command to modify, in 128 characters.

Example: The following example sets the privilege level to 15 for any Exec mode (user or privileged) command.

```
# config t
(config)# privilege exec level 15 host
```

Negation: (config)# no privilege { exec | configure | config-vlan | line | interface | if-vlan | ipmc-profile | snmps-host | stp-aggr | dhcp-pool | rfc2544-profile } level <0-15> <cmd>

Show: > show privilege
show privilege

3.9.32 (config)# prompt

Syntax: (config)# prompt <prompt>

Explanation: Set up prompt message before prompted mode symbol.

Parameters:

<prompt>]: The prompt message should begin with a "%" sign and then a character. Available prompt messages include the following:

- %h = hostname
- %%= percent sign
- %s= space
- %t= tab
- %D= date
- %T= time
- %Z= date and time

Negation: (config)# no prompt

Example: Set the current date and time as a prompt message.

```
# config t
(config)# prompt %Z
2019-10-03T17:33:25+00:00 (config) #
```

3.9.33 (config)# qos

3.9.33.1 (config)# qos map cos-dscp

Syntax: (config)# qos map cos-dscp <cos> dpl <dpl> dscp { <dscp_num> | { be | af11 | af12 | af13 | af21 | af22 | af23 | af31 | af32 | af33 | af41 | af42 | af43 | cs1 | cs2 | cs3 | cs4 | cs5 | cs6 | cs7 | ef | va } }

Parameters:

cos-dscp <cos>: Map COS to DSCP. Indicate the Class of Service level. The allowed range is 0 to 7. A CoS class of 0 has the lowest priority, while 7 has the highest priority.

dpl <dpl>: Specify the Drop Precedence Level. The allowed range is 0 to 7.

dscp { <dscp_num> | { be | af11 | af12 | af13 | af21 | af22 | af23 | af31 | af32 | af33 | af41 | af42 | af43 | cs1 | cs2 | cs3 | cs4 | cs5 | cs6 | cs7 | ef | va } }: Specify one of the DSCP values.

<dscp_num: 0-63>: The allowed number is from 0 to 63.

be: Default PHB (DSCP 0) for best effort traffic.

af11 | af12 | af13 | af21 | af22 | af23 | af31 | af32 | af33 | af41 | af42 | af43: Assured Forwarding PHB AF 11 (DSCP 10), 12 (DSCP 12), 13 (DSCP 14), 21 (DSCP 18), 22 (DSCP 20), 23 (DSCP 22), 31 (DSCP 26), 32 (DSCP 28), 33 (DSCP 30), 41 (DSCP 34), 42 (DSCP 36).

cs1 | cs2 | cs3 | cs4 | cs5 | cs6 | cs7: Class selector PHB CS1 precedence 1 (DSCP 8), CS2 precedence 2 (DSCP 16), CS3 precedence 3 (DSCP 24), CS4 precedence 4 (DSCP 32), CS5 precedence 5 (DSCP 40), CS6 precedence 6 (DSCP 48), CS7 precedence 7 (DSCP 56).

ef: Expedited Forwarding PHB (DSCP 46).

va: Voice Admit PHB (DSCP 44).

Explanation: Configure the COS-DSCP mapping.

Example: The following example sets DPL to 4, DSCP to cs4.

```
# config t
(config)# qos map cos-dscp 4 dpl 4 dscp cs4
```

Negation: (config)# no qos map cos-dscp <cos> dpl <dpl>

Show: # show qos

```
# show qos [ { interface [ ( <port_type> [ <port> ] ) ] } | { maps [ dscp-cos ] [ dscp-ingress-translation ] [ dscp-classify ] [ cos-dscp ] [ dscp-egress-translation ] } | storm | { qce [ <qce> ] } }
```

3.9.33.2 (config)# qos map dscp-classify

Syntax: (config)# qos map dscp-classify { <dscp_num> | { be | af11 | af12 | af13 | af21 | af22 | af23 | af31 | af32 | af33 | af41 | af42 | af43 | cs1 | cs2 | cs3 | cs4 | cs5 | cs6 | cs7 | ef | va } }

Parameters:

dscp-classify { <dscp_num> | { be | af11 | af12 | af13 | af21 | af22 | af23 | af31 | af32 | af33 | af41 | af42 | af43 | cs1 | cs2 | cs3 | cs4 | cs5 | cs6 | cs7 | ef | va } }; Specify one of the DSCP values.

<dscp_num: 0-63>: The allowed number is from 0 to 63.

be: Default PHB (DSCP 0) for best effort traffic.

af11 | af12 | af13 | af21 | af22 | af23 | af31 | af32 | af33 | af41 | af42 | af43: Assured Forwarding PHB AF 11 (DSCP 10), 12 (DSCP 12), 13 (DSCP 14), 21 (DSCP 18), 22 (DSCP 20), 23 (DSCP 22), 31 (DSCP 26), 32 (DSCP 28), 33 (DSCP 30), 41 (DSCP 34), 42 (DSCP 36).

cs1 | cs2 | cs3 | cs4 | cs5 | cs6 | cs7: Class selector PHB CS1 precedence 1 (DSCP 8), CS2 precedence 2 (DSCP 16), CS3 precedence 3 (DSCP 24), CS4 precedence 4 (DSCP 32), CS5 precedence 5 (DSCP 40), CS6 precedence 6 (DSCP 48), CS7 precedence 7 (DSCP 56).

ef: Expedited Forwarding PHB (DSCP 46).

va: Voice Admit PHB (DSCP 44).

Explanation: Configure the DSCP Ingress classification.

Example: The following example sets DSCP Ingress classification to cs4.

```
# config t
(config)# qos map dscp-classify cs4
```

Negation: (config)# no qos map dscp-classify { <dscp_num> | { be | af11 | af12 | af13 | af21 | af22 | af23 | af31 | af32 | af33 | af41 | af42 | af43 | cs1 | cs2 | cs3 | cs4 | cs5 | cs6 | cs7 | ef | va } }

Show: # show qos

```
# show qos [ { interface [ ( <port_type> [ <port> ] ) ] } | { maps [ dscp-cos ] [ dscp-ingress-translation ] [dscp-classify] [ cos-dscp ] [ dscp-egress-translation ] } | storm | { qce [ <qce> ] } ]
```

3.9.33.3 (config)# qos map dscp-cos

Syntax: (config)# qos map dscp-cos { <dscp_num> | { be | af11 | af12 | af13 | af21 | af22 | af23 | af31 | af32 | af33 | af41 | af42 | af43 | cs1 | cs2 | cs3 | cs4 | cs5 | cs6 | cs7 | ef | va } } cos <cos> dpl <dpl>

Explanation: Configure the DSCP-based QoS Ingress classification.

Parameters:

dscp-cos { <dscp_num> | { be | af11 | af12 | af13 | af21 | af22 | af23 | af31 | af32 | af33 | af41 | af42 | af43 | cs1 | cs2 | cs3 | cs4 | cs5 | cs6 | cs7 | ef | va } }; Specify one of the DSCP values.

<dscp_num: 0-63>: The allowed number is from 0 to 63.

be: Default PHB (DSCP 0) for best effort traffic.

af11 | af12 | af13 | af21 | af22 | af23 | af31 | af32 | af33 | af41 | af42 | af43: Assured Forwarding PHB AF 11 (DSCP 10), 12 (DSCP 12), 13 (DSCP 14), 21 (DSCP 18), 22 (DSCP 20), 23 (DSCP 22), 31 (DSCP 26), 32 (DSCP 28), 33 (DSCP 30), 41 (DSCP 34), 42 (DSCP 36).

cs1 | cs2 | cs3 | cs4 | cs5 | cs6 | cs7: Class selector PHB CS1 precedence 1 (DSCP 8), CS2 precedence 2 (DSCP 16), CS3 precedence 3 (DSCP 24), CS4 precedence 4 (DSCP 32), CS5 precedence 5 (DSCP 40), CS6 precedence 6 (DSCP 48), CS7 precedence 7 (DSCP 56).

ef: Expedited Forwarding PHB (DSCP 46).

va: Voice Admit PHB (DSCP 44).

cos <cos>: Indicate the Class of Service level. The allowed range is 0 to 7. A CoS class of 0 has the lowest priority, while 7 has the highest priority.

dpl <dpl>: Specify the Drop Precedence Level. The allowed range is 0 to 7.

Negation: (config)# no qos map dscp-cos { <dscp_num> | { be | af11 | af12 | af13 | af21 | af22 | af23 | af31 | af32 | af33 | af41 | af42 | af43 | cs1 | cs2 | cs3 | cs4 | cs5 | cs6 | cs7 | ef | va } }

Show: # show qos

```
# show qos [ { interface [ ( <port_type> [ <port> ] ) ] } | { maps [ dscp-cos ] [ dscp-ingress-translation ] [ dscp-classify ] [ cos-dscp ] [ dscp-egress-translation ] } | storm | { qce [ <qce> ] } }
```

3.9.33.4 (config)# qos map dscp-egress-translation

Syntax: (config)# qos map dscp-egress-translation { <dscp_num> | { be | af11 | af12 | af13 | af21 | af22 | af23 | af31 | af32 | af33 | af41 | af42 | af43 | cs1 | cs2 | cs3 | cs4 | cs5 | cs6 | cs7 | ef | va } } to { <dscp_num_tr> | { be | af11 | af12 | af13 | af21 | af22 | af23 | af31 | af32 | af33 | af41 | af42 | af43 | cs1 | cs2 | cs3 | cs4 | cs5 | cs6 | cs7 | ef | va } }

Explanation: Configure the DSCP Egress Mapping Table.

Parameters:

dscp-egress-translation { <dscp_num> | { be | af11 | af12 | af13 | af21 | af22 | af23 | af31 | af32 | af33 | af41 | af42 | af43 | cs1 | cs2 | cs3 | cs4 | cs5 | cs6 | cs7 | ef | va } }: Specify one of the DSCP values.

<dscp_num: 0-63>: The allowed number is from 0 to 63.

be: Default PHB (DSCP 0) for best effort traffic.

af11 | af12 | af13 | af21 | af22 | af23 | af31 | af32 | af33 | af41 | af42 | af43: Assured Forwarding PHB AF 11 (DSCP 10), 12 (DSCP 12), 13 (DSCP 14), 21 (DSCP 18), 22 (DSCP 20), 23 (DSCP 22), 31 (DSCP 26), 32 (DSCP 28), 33 (DSCP 30), 41 (DSCP 34), 42 (DSCP 36).

cs1 | cs2 | cs3 | cs4 | cs5 | cs6 | cs7: Class selector PHB CS1 precedence 1 (DSCP 8), CS2 precedence 2 (DSCP 16), CS3 precedence 3 (DSCP 24), CS4 precedence 4 (DSCP 32), CS5 precedence 5 (DSCP 40), CS6 precedence 6 (DSCP 48), CS7 precedence 7 (DSCP 56).

ef: Expedited Forwarding PHB (DSCP 46).

va: Voice Admit PHB (DSCP 44).

Example: The following example maps cs4 to cs5.

```
# config t
(config)# qos map dscp-egress-translation cs4 to cs5
```

Negation: (config)# no qos map dscp-egress-translation { <dscp_num> | { be | af11 | af12 | af13 | af21 | af22 | af23 | af31 | af32 | af33 | af41 | af42 | af43 | cs1 | cs2 | cs3 | cs4 | cs5 | cs6 | cs7 | ef | va } } <dpl>

Show: # show qos

```
# show qos [ { interface [ ( <port_type> [ <port> ] ) ] } | { maps [ dscp-cos ] [ dscp-ingress-translation ] [ dscp-classify ] [ cos-dscp ] [ dscp-egress-translation ] } | storm | { qce [ <qce> ] } ]
```

3.9.33.5 (config)# qos map dscp-ingress-translation

Syntax: (config)# qos map dscp-ingress-translation { <dscp_num> | { be | af11 | af12 | af13 | af21 | af22 | af23 | af31 | af32 | af33 | af41 | af42 | af43 | cs1 | cs2 | cs3 | cs4 | cs5 | cs6 | cs7 | ef | va } } to { <dscp_num_tr> | { be | af11 | af12 | af13 | af21 | af22 | af23 | af31 | af32 | af33 | af41 | af42 | af43 | cs1 | cs2 | cs3 | cs4 | cs5 | cs6 | cs7 | ef | va } }

Explanation: Configure the DSCP Ingress Mapping Table.

Parameters:

dscp-ingress-translation { <dscp_num> | { be | af11 | af12 | af13 | af21 | af22 | af23 | af31 | af32 | af33 | af41 | af42 | af43 | cs1 | cs2 | cs3 | cs4 | cs5 | cs6 | cs7 | ef | va } }: Specify one of the DSCP values.

<dscp_num: 0-63>: The allowed number is from 0 to 63.

be: Default PHB (DSCP 0) for best effort traffic.

af11 | af12 | af13 | af21 | af22 | af23 | af31 | af32 | af33 | af41 | af42 | af43: Assured Forwarding PHB AF 11 (DSCP 10), 12 (DSCP 12), 13 (DSCP 14), 21 (DSCP 18), 22 (DSCP 20), 23 (DSCP 22), 31 (DSCP 26), 32 (DSCP 28), 33 (DSCP 30), 41 (DSCP 34), 42 (DSCP 36).

cs1 | cs2 | cs3 | cs4 | cs5 | cs6 | cs7: Class selector PHB CS1 precedence 1 (DSCP 8), CS2 precedence 2 (DSCP 16), CS3 precedence 3 (DSCP 24), CS4 precedence 4 (DSCP 32), CS5 precedence 5 (DSCP 40), CS6 precedence 6 (DSCP 48), CS7 precedence 7 (DSCP 56).

ef: Expedited Forwarding PHB (DSCP 46).

va: Voice Admit PHB (DSCP 44).

Example: The following example maps cs4 to cs5.

```
# config t
(config)# qos map dscp-ingress-translation cs4 to cs5
```

Negation: (config)# no qos map dscp-ingress-translation { <dscp_num> | { be | af11 | af12 | af13 | af21 | af22 | af23 | af31 | af32 | af33 | af41 | af42 | af43 | cs1 | cs2 | cs3 | cs4 | cs5 | cs6 | cs7 | ef | va } }

Show: # show qos

```
# show qos [ { interface [ ( <port_type> [ <port> ] ) ] } | { maps [ dscp-cos ] [ dscp-ingress-translation ] [ dscp-classify ] [ cos-dscp ] [ dscp-egress-translation ] } | storm | { qce [ <qce> ] } }
```

3.9.33.6 (config)# qos qce refresh

Syntax: (config)# qos qce refresh

Explanation: To refresh QCE.

Example: Refresh QCE.

```
# config t
(config)# qos qce refresh
```

3.9.33.7 (config)# qos qce update

Syntax: (config)# qos qce { [update] } <qce_id> [{ next <qce_id_next> } | last] [interface (<port_type> [<port_list>])] [smac { <smac> | <smac_24> | any }] [dmac { <dmac> | unicast | multicast | broadcast | any }] [tag { [type { untagged | tagged | c-tagged | s-tagged | any }] [vid { <ot_vid> | any }] [pcp { <ot_pcp> | any }] [dei { <ot_dei> | any }] } *1] [inner-tag { [type { untagged | tagged | c-tagged | s-tagged | any }] [vid { <it_vid> | any }] [pcp { <it_pcp> | any }] [dei { <it_dei> | any }] } *1] [frame-type { any | { etype [{ <etype_type> | any }] } | llc [dsap { <llc_dsap> | any }] [ssap { <llc_ssap> | any }] [control { <llc_control> | any }] } | { snap [{ <snap_data> | any }] } | { ipv4 [proto { <pr4> | tcp | udp | any }] [sip { <sip4> | any }] [dip { <dip4> | any }] [dscp { <dscp4> | { be | af11 | af12 | af13 | af21 | af22 | af23 | af31 | af32 | af33 | af41 | af42 | af43 | cs1 | cs2 | cs3 | cs4 | cs5 | cs6 | cs7 | ef | va } | any }] [fragment { yes | no | any }] [sport { <sp4> | any }] [dport { <dp4> | any }] } | { ipv6 [proto { <pr6> | tcp | udp | any }] [sip { <sip6> | any }] [dip { <dip6> | any }] [dscp { <dscp6> | { be | af11 | af12 | af13 | af21 | af22 | af23 | af31 | af32 | af33 | af41 | af42 | af43 | cs1 | cs2 | cs3 | cs4 | cs5 | cs6 | cs7 | ef | va } | any }] [sport { <sp6> | any }] [dport { <dp6> | any }] } }] [action [{ cos { <action_cos> | default } } [dpl { <action_dpl> | default }] [pcp-dei { <action_pcp> <action_dei> | default }] [dscp { <action_dscp_dscp> | { be | af11 | af12 | af13 | af21 | af22 | af23 | af31 | af32 | af33 | af41 | af42 | af43 | cs1 | cs2 | cs3 | cs4 | cs5 | cs6 | cs7 | ef | va } | default }] [policy { <action_policy> | default }] } *1]

Explanation: To update the QCE.

Parameters:

[update]: Update the QCE.

<qce_id>: Specify the QCE ID.

[{ next <qce_id_next> } | last]: Put this QCE next to the specified one or to the last one.

[interface (<port_type> [<port_list>])]: Specify port type and port number that apply to this updated QCE rule.

[smac { <smac> | <smac_24> | any }]: Set up the matched SMAC.

[dmac { <dmac> | unicast | multicast | broadcast | any }]: Set up the matedched DMAC.

[tag { [type { untagged | tagged | c-tagged | s-tagged | any }] }]: Set up the matched tag type.

[vid { <ot_vid> | any }]: Specify a specific VID or VID range or specify “any” to allow any VIDs.

[pcp { <ot_pcp> | any }]: Specify a specific PCP or PCP range or specify “any” to allow any PCP values.

[dei { <ot_dei> | any }]]: Specify a specific DEI or specify “any” to allow any DEI.

[frame-type { any | { etype [{ <etype_type> | any }] } | llc [dsap { <llc_dsap> | any }] [ssap { <llc_ssap> | any }] [control { <llc_control> | any }] } | { snap [{ <snap_data> | any }] } | { ipv4 [proto { <pr4> | tcp | udp | any }] [sip { <sip4> | any }] [dip { <dip4> | any }] [dscp { <dscp4> | { be | af11 | af12 | af13 | af21 | af22 | af23 | af31 | af32 | af33 | af41 | af42 | af43 | cs1 | cs2 | cs3 | cs4 | cs5 | cs6 | cs7 | ef | va } | any }] [fragment { yes | no | any }] [sport { <sp4> | any }] [dport { <dp4> | any }] } | { ipv6 [proto { <pr6> | tcp | udp | any }] [sip { <sip6> | any }] [dip { <dip6> | any }] [dscp { <dscp6> | { be | af11 | af12 | af13 | af21 | af22 | af23 | af31 | af32 | af33 | af41 | af42 | af43 | cs1 | cs2 | cs3 | cs4 | cs5 | cs6 | cs7 | ef | va } | any }] [sport { <sp6> | any }] [dport { <dp6> | any }] }]]: Specify the frame type that applies to this QCE rule.

any: By default, any is used which means that all types of frames are allowed.

etype: This option can only be used to filter Ethernet II formatted packets. (Options: Any, Specific – 600-ffff hex; Default: ffff). Note that 800 (IPv4) and 86DD (IPv6) are excluded. A detailed listing of Ethernet protocol types can be found in RFC 1060. A few of the more common types include 0800 (IP), 0806 (ARP), 8137 (IPX).

llc: LLC refers to Link Logical Control and further provides three options.

dsap: DSAP stands for Destination Service Access Point address. By default, any is used. Specify “any” or indicate a value (0x00 to 0xFF).

ssap: SSAP stands for Source Service Access Point address. By default, any is used. Specify “any” or indicate a value (0x00 - 0xFF).

control: Control field may contain command, response, or sequence information depending on whether the LLC frame type is Unnumbered, Supervisory, or Information. By default, any is used. Specify “any” or indicate a value (0x00 to 0xFF).

snap: SubNetwork Access Protocol can be distinguished by an OUI and a Protocol ID. (Options for PID: Any, Specific (0x00-0xffff); Default: Any) If the OUI is hexadecimal 000000, the protocol ID is the Ethernet type (EtherType) field value for the protocol running on top of SNAP. If the OUI is that of a particular organization, the protocol ID is a value assigned by that organization to the protocol running on top of SNAP. In other words, if value of the OUI field is 00-00-00, then value of the PID will be etherType (0x0600-0xffff), and if value of the OUI is other than 00-00-00, then valid value of the PID will be any value from 0x0000 to 0xffff.

ipv4:

proto: IPv4 frame type includes Any, TCP, UDP, Other. If “TCP” or “UDP” is specified, you might further define Sport (Source port number) and Dport (Destination port number).

sip: Specify source IP type. By default, any is used. Indicate self-defined source IP and submask format. The address and mask must be in the format x.y.z.w where x, y, z, and w are decimal numbers between 0 and 255. When the mask is converted to a 32-bit binary string and read from left to right, all bits following the first zero must also be zero

dscp: By default, any is used. Indicate a DSCP value or a range of DSCP value.

fragment: By default, any is used. Datagrams sometimes may be fragmented to ensure they can pass through a network device that uses a maximum transfer unit smaller than the original packet’s size.

ipv6:

proto: IPv6 protocol includes Any, TCP, UDP, Other. If “TCP” or “UDP” is specified, you may need to further define Sport (Source port number) and Dport (Destination port number).

sip: Specify source IP type. By default, any is used. You can also indicate self-defined source IP and submask format.

dscp: By default, any is used. You can also indicate a DSCP value or a range of DSCP value.

[action { [cos { <action_cos> | default }] }]: Specify the classification action taken on ingress frame if the parameters match the frame's content. If a frame matches the QCE, it will be put in the queue corresponding to the specified QoS class or placed in a queue based on basic classification rules.

[dpl { <action_dpl> | default }]: If a frame matches the QCE, the drop precedence level will be set to the specified value or left unchanged.

[pcp-dei { <action_pcp> <action_dei> | default }]: If a frame matches the QCE, the PCP or DEI value will be set to the specified one.

[dscp { <action_dscp_dscp> { be | af11 | af12 | af13 | af21 | af22 | af23 | af31 | af32 | af33 | af41 | af42 | af43 | cs1 | cs2 | cs3 | cs4 | cs5 | cs6 | cs7 | ef | va } | default }] [policy { <action_policy> | default }]*1]: If a frame matches the QCE, the DSCP value will be set to the specified one.

Negation: (config)# no qos qce <qce_id_range>

Show: # show qos

```
# show qos [ { interface [ ( <port_type> [ <port> ] ) ] } | { maps [ dscp-cos ] [ dscp-ingress-translation ] [ dscp-classify ] [ cos-dscp ] [ dscp-egress-translation ] } | storm | { qce [ <qce> ] } ]
```

3.9.33.8 (config)# qos storm

Syntax: (config)# qos storm { unicast | multicast | broadcast } { <rate> [kfps] | { 1024 kfps } }

Explanation: Configure broadcast storm control rate for QoS

Parameters:

{ unicast | multicast | broadcast } : Specify the storm type that you want to configure.

{ <rate> [kfps] | { 1024 kfps } } : User-define storm frame rate or set storm rate to 1024 kfps.

Example: The following example sets broadcast storm control for QoS to 1024 kfps.

```
# config t
(config)# qos storm broadcast 1024 kfps
```

Negation: (config)# no qos storm { unicast | multicast | broadcast }

Show: # show qos storm

3.9.34 (config)# radius-server

3.9.34.1 (config)# radius-server attribute 32

Syntax: (config)# radius-server attribute 32 <id>

Explanation: Configure Radius attribute 32 string.

Parameters:

<id>: Specify Radius server identifier. The allowed characters are 1 to 253.

Example: Set RADIUS attribute 32 string to "cabinet5aSW".

```
# config t
(config)# radius-server attribute 32 cabinet5aSW
```

Negation: (config)# no radius-server attribute 32

Show: # show radius-server [statistics]

3.9.34.2 (config)# radius-server attribute 4

Syntax: (config)# radius-server attribute 4 <ipv4>

Explanation: Configure NAS IPv4 address.

Parameters:

<ipv4>: Specify NAS IPv4 address.

Example: Set NAS IPv4 address to 100.1.1.25.

```
# config t
(config)# radius-server attribute 4 100.1.1.25
```

Negation: (config)# no radius-server attribute 4

Show: # show radius-server [statistics]

3.9.34.3 (config)# radius-server attribute 95

Syntax: (config)# radius-server attribute 95 <ipv6>

Explanation: Configure NAS IPv6 address.

Parameters:

<ipv6>: Specify NAS IPv6 address.

Negation: (config)# no radius-server attribute 95

Show: # show radius-server [statistics]

3.9.34.4 (config)# radius-server deadtime

Syntax: (config)# radius-server deadtime <minutes>

Explanation: Configure RADIUS server deadtime value. Deadtime is the period during which the switch will not send new requests to a server that has failed to respond to a previous request. This will stop the switch from continually trying to contact a server that it has already determined as dead.

Parameters:

<deadtime>: Specify RADIUS server deadtime value. The valid range is 1 to 1440 (minutes).

Example: Set RADIUS server to 60.

```
# config t
(config)# radius-server deadtime 60
```

Negation: (config)# no radius-server deadtime

Show: # show radius-server [statistics]

3.9.34.5 (config)# radius-server host

Syntax: (config)# radius-server host <host_name> [auth-port <auth_port>] [acct-port <acct_port>] [timeout <seconds>] [retransmit <retries>] [key { [unencrypted] <unencrypted_key> | encrypted <encrypted_key> }]

Explanation: This command is used to configure Radius server.

Parameters:

<host_name>: Specify the hostname or IP address for the radius server. The allowed characters are 1 to 255.

[auth-port <auth_port>]: Specify the UDP port to be used on the RADIUS server for authentication.

[acct-port <acct_port>]: Specify the UDP port to be used on the RADIUS server for accounting.

[timeout <seconds>]: Specify a timeout value. If timeout value is specified here, it will replace the global timeout value. If you prefer to use the global value, leave this field blank.

[retransmit <retries>]: Specify a value for retransmit retry. If retransmit value is specified here, it will replace the global retransmit value. If you prefer to use the global value, leave this field blank.

[key { [unencrypted] <unencrypted_key> | encrypted <encrypted_key> }]: Specify an unencrypted or encrypted secret key. If secret key is specified here, it will replace the global secret key. If you prefer to use the global value, leave this field blank.

Negation: (config)# no radius-server host <host_name> [auth-port <auth_port>] [acct-port <acct_port>]

Show: # show radius-server [statistics]

3.9.34.6 (config)# radius-server key

Syntax: (config)# radius-server key <key>

Explanation: Configure RADIUS server key value. This key is shared between the RADIUS sever and the switch.

Parameters:

<key>: Specify RADIUS server secret key value. The valid range is 1 to 63.

Example: Set RADIUS server secret key to 803321

```
# config t
(config)# radius-server key 803321
```

Negation: (config)# no radius-server key

3.9.34.7 (config)# radius-server retransmit

Syntax: (config)# radius-server retransmit <retries>

Explanation: Configure the number of times to retransmit request packets to an authentication server that does not respond. If the server does not respond after the last retransmit is sent, the switch considers the authentication server is dead.

Parameters:

<retries>: Specify RADIUS server retransmit value. The valid range is 1 to 1000.

Example: Set RADIUS server retransmit value to 5

```
# config t
(config)# radius-server retransmit 5
```

Negation: (config)# no radius-server retransmit

Show: # show radius-server [statistics]

3.9.34.8 (config)# radius-server timeout

Syntax: (config)# radius-server timeout <seconds>

Explanation: Configure the time the switch waits for a reply from an authentication server before it retransmits the request.

Parameters:

<seconds>: Specify RADIUS server timeout value. The valid range is 1 to 1000.

Example: Set RADIUS server timeout to 60

```
# config t
(config)# radius-server timeout 60
```

Negation: (config)# no radius-server timeout

Show: # show radius-server [statistics]

3.9.35 (config)# ring

3.9.35.1 (config)# ring <instance> chain

Syntax: (config)# ring <instance> chain [master] east interface <port_type> <east_port> [edge] west interface <port_type> <west_port> [edge]

Parameters:

<instance: 0-3>: Specify the ring instance number.

chain: This is a chain ring.

[master]: Set this ring to master ring.

east interface <port_type> <east_port> [edge]: Specify the east port type (Fast Ethernet or Gigabit Ethernet) and port number. If this port is the edge port, add “edge” after the port number.

west interface <port_type> <west_port> [edge]: Specify the west port type (Fast Ethernet or Gigabit Ethernet) and port number. If this port is the edge port, add “edge” after the port number.

Explanation: Create a chain ring instance.

Example: Create a chain instance 1.

```
# config t
(config)# ring 1 chain east interface FastEthernet 1/1 west interface
FastEthernet 1/2
```

Negation: (config)# no ring <instance>

Show: # show ring [<instances>]

3.9.35.2 (config)# ring <instance> ring

Syntax: (config)# ring <instance> ring [master] east interface <port_type> <east_port> west interface <port_type> <west_port>

Parameters:

<instance: 0-3>: Specify the ring instance number.

ring: This is a closed ring type.

[master]: Set this ring to master ring.

east interface <port_type> <east_port>: Specify the east port type (Fast Ethernet or Gigabit Ethernet) and port number.

west interface <port_type> <west_port>: Specify the west port type (Fast Ethernet or Gigabit Ethernet) and port number.

Explanation: Create a closed ring instance.

Example: Create a ring instance 2.

```
# config t
(config)# ring 2 ring east interface GigabitEthernet 1/3 west interface
GigabitEthernet 1/4
```

Negation: (config)# no ring <instance>

Show: # show ring [<instances>]

3.9.35.3 (config)# ring <instance> sub

Syntax: (config)# ring <instance> sub [master] east interface <port_type> <east_port>

Parameters:

<instance: 0-3>: Specify the ring instance number.

sub: This is a sub-ring type.

[master]: Set this ring to master ring.

east interface <port_type> <east_port>: Specify the east port type (Fast Ethernet or Gigabit Ethernet) and port number.

Explanation: Create a sub ring instance.

Example: Create a ring instance 3.

```
# config t
(config)# ring 3 ring east interface FastEthernet 1/1
```

Negation: (config)# no ring <instance>

Show: # show ring [<instances>]

3.9.36 (config)# rmon

3.9.36.1 (config)# rmon alarm

Syntax: (config)# rmon alarm <id> { ifInOctets | ifInUcastPkts | ifInNUcastPkts | ifInDiscards | ifInErrors | ifInUnknownProtos | ifOutOctets | ifOutUcastPkts | ifOutNUcastPkts | ifOutDiscards | ifOutErrors } <ifIndex> <interval> { absolute | delta } rising-threshold <rising_threshold> [<rising_event_id>] falling-threshold <falling_threshold> [<falling_event_id>] { [rising | falling | both] }

Explanation: Configure RMON alarm settings. RMON Alarm configuration defines specific criteria that will generate response events. It can be set to test data over any specified time interval and can monitor absolute or changing values. Alarms can also be set to respond to rising or falling thresholds.

Parameters:

<id>: Indicates the index of the entry. The range is from 1 to 65535.

<oid_str>: The object number of the MIB variable to be sampled. Only variables of the type ifEntry.n.n may be sampled. Possible variables are ifInOctets, ifInUcastPkts, ifInNUcastPkts, ifOutDiscards, ifErrors, ifInUnknownProtos, ifOutOctets, ifOutUcastPkts, ifOutNUcastPkts, ifOutDiscards, ifOutErrors.

<interval>: The polling interval for sampling and comparing the rising and falling threshold. The range is from 1 to 2³¹ (2147483647) seconds.

{ absolute | delta }: Test for absolute or relative change in the specified variable.

Absolute: The variable is compared to the thresholds at the end of the sampling period.

Delta: The last sample is subtracted from the current value and the difference is compared to the thresholds.

rising-threshold <rising_threshold>: If the current value is greater than the rising threshold and the last sample value is less than this threshold, then an alarm will be triggered. After a rising event has been generated, another such event will not be generated until the sampled value has fallen below the rising threshold, reaches the falling threshold, and again moves back up to the rising threshold. The threshold range is -2147483647 to 2147483647.

[<rising_event_id>]: Indicates the rising index of an event. The range is 1 - 65535.

falling-threshold <falling_threshold>: If the current value is less than the falling threshold, and the last sample value was greater than this threshold, then an alarm will be generated. After a falling event has been generated, another such event will not be generated until the sampled value has risen above the falling threshold, reaches the rising threshold, and again moves back down to the failing threshold. (Range: -2147483647 to 2147483647)

[<falling_event_id>]: Indicates the falling index of an event. The range is 0 - 65535.

{ [rising | falling | both] }: Specify a method that is used to sample the selected variable and calculate the value to be compared against the thresholds.

rising: Trigger alarm when the first value is larger than the rising threshold.

falling: Trigger alarm when the first value is less than the falling threshold.

both: Trigger alarm when the first value is larger than the rising threshold or less than the falling threshold.

Negation: (config)# no rmon alarm <id>

Show: # show rmon alarm [<id_list>]
show rmon history [<id_list>]
show rmon statistics [<id_list>]

3.9.36.2 (config)# rmon event

Syntax: (config)# rmon event <id> [log] [trap <community>] { [description <description>] }

Explanation: Configure RMON Event settings.

Parameters:

<id>: Specify an ID index. The range is 1 - 65535.

[log]: When the event is triggered, a RMON log entry will be generated.

[trap <community>]: A password-like community string sent with the trap. Although the community string can be set on this configuration page, it is recommended that it be defined on the SNMP trap configuration page prior to configuring it here. The allowed characters are 0 - 127.

{ [description <description>] }: Enter a descriptive comment for this entry.

Negation: (config)# no rmon event <id>

Show: # show rmon alarm [<id_list>]
show rmon history [<id_list>]

3.9.37 (config)# snmp-server

3.9.37.1 (config)# snmp-server

Syntax: (config)# snmp-server

Explanation: Enable SNMP server service.

Example: Enable SNMP server service.

```
# config t
(config)# snmp-server
```

Negation: (config)# no snmp-server

Show: # show snmp

3.9.37.2 (config)# snmp-server access

Syntax: (config)# snmp-server access <group_name> model { v1 | v2c | v3 | any } level { auth | noauth | priv } [read <view_name>] [write <write_name>]

Explanation: Configure SNMP access settings.

Parameters:

<group_name>: A string identifying the group name that this entry should belong to. The allowed string length is 1 to 32, and the allowed content is ASCII characters from 0x21 to 0x7E.

model { v1 | v2c | v3 | any }: Indicates the security model that this entry should belong to. Possible security models are:

any: Any security model accepted(v1|v2c|usm).

v1: Reserved for SNMPv1.

v2c: Reserved for SNMPv2c.

v3: User-based Security Model (USM) for SNMPv3.

level { auth | noauth | priv }: Indicates the security level that this entry should belong to. Possible security models are:

auth: Authentication and no privacy.

noauth: No authentication and no privacy.

priv: Authentication and privacy.

[read <view_name>]: The name of the MIB view defining the MIB objects for which this request may request the current values. The allowed string length is 1 to 32, and the allowed content is ASCII characters from 0x21 to 0x7E.

[write <write_name>]: The name of the MIB view defining the MIB objects for which this request may potentially set new values. The allowed string length is 1 to 32, and the allowed content is ASCII characters from 0x21 to 0x7E.

Negation: (config)# no snmp-server access <group_name> model { v1 | v2c | v3 | any } level { auth | noauth | priv }

Show: # show snmp access [<group_name> { v1 | v2c | v3 | any } { auth | noauth | priv }]

3.9.37.3 (config)# snmp-server community

Syntax: (config)# snmp-server community <v3_comm> [< ip-range <v_ipv4_addr> <v_ipv4_netmask> | ipv6-range <v_ipv6_addr> <v_ipv6_netmask>] { <v3_sec> | encrypted <v3_sec_enc> }

Explanation: Configure SNMP server community v3 value.

Parameters:

<v3_comm>: Specify SNMPv3 community string.

[ip-range <v_ipv4_addr> <v_ipv4_netmask> | ipv6-range <v_ipv6_addr> <v_ipv6_netmask>]: Specify IPv4 or IPv6 address and subnet mask address.

Negation: (config)# no snmp-server community <v3_comm> [{ ip-range <v_ipv4_addr> <v_ipv4_netmask> | ipv6-range <v_ipv6_subnet> }]

Show: # show snmp
show snmp community [<community>]

3.9.37.4 (config)# snmp-server contact

Syntax: (config)# snmp-server contact <v_line255>

Explanation: Configure system contact information.

Parameters:

<v_line255>: Specify system contact information. This could be a person's name, email address or other descriptions. The allowed string length is 0 – 255 and the allowed content is the ASCII characters from 32 – 126.

Example: Set system contact information to “admin@acme.com”

```
# config t
(config)# snmp-server contact admin@acme.com
```

Negation: (config)# no snmp-server contact

3.9.37.5 (config)# snmp-server engine-id local

Syntax: (config)# snmp-server engine-id local <engineID>

Explanation: Configure SNMP server v3 Engine ID value.

Parameters:

<engineID>: Indicates the SNMPv3 engine ID. The string must contain an even number (in hexadecimal format) with number of digits between 10 and 64, but all-zeros and all-F's are not allowed. Changes to the Engine ID will clear all original local users.

Negation: (config)# no snmp-server engine-id local

Show: # show snmp

3.9.37.6 (config)# snmp-server host

Syntax: (config)# snmp-server host <conf_name>

Explanation: Configure SNMP server hostname.

Parameters:

<conf_name: word 32>: Specify a host name. Once “Enter” is pressed, the CLI prompt changes to (config-snmps-host)#.

Example: Set SNMP server hostname to RemoteSnmp

```
# config t
(config)# snmp-server host RemoteSnmp
(config-snmps-host) #
```

Negation: (config)# snmp-server host <conf_name>

Show: # show snmp host [<conf_name>] [system] [switch] [power] [interface] [aaa]

3.9.37.6.1 (config-snmps-host)# host <v_ipv6_ucast>

Syntax: (config-snmps-host)# host <v_ipv6_ucast> [<udp_port>] [traps | informs]

Explanation: Indicates the SNMP trap destination address.

Parameters:

<v_ipv6_ucast>: Specify the IPv6 address. It allows a valid IP address in dotted decimal notation ('x.y.z.w'). Also allowed is a valid hostname. A valid hostname is a string drawn from the alphabet (A-Z; a-z), digits (0-9), dot (.) and dash (-). Spaces are not allowed. The first character must be an alpha character, and the first and last characters cannot be a dot or a dash.

[<udp_port>]: Indicates the SNMP trap destination port. SNMP Agent will send SNMP message via this port, the port range is 1~65535. The default SNMP trap port is 162.

[traps | informs]: Specify one of the options.

Negation: (config-snmps-host)# no host

3.9.37.6.2 (config-snmps-host)# host <v_ipv4_ucast>

Syntax: (config-snmps-host)# host { <v_ipv4_ucast> | <v_word45> } [<udp_port>] [traps | informs]

Explanation: Configure the SNMP trap destination IPv4 address.

Parameters:

{ <v_ipv4_ucast> | <v_word45> }: Indicates the SNMP trap destination address. It allows a valid IP address in dotted decimal notation ('x.y.z.w'). Also allowed is a valid hostname. A valid hostname is a string drawn from the alphabet (A-Z; a-z), digits (0-9), dot (.) and dash (-). Spaces are not allowed. The first character must be an alpha character, and the first and last characters cannot be a dot or a dash.

[<udp_port>]: Indicates the SNMP trap destination port. SNMP Agent will send SNMP message via this port, the port range is 1~65535. The default SNMP trap port is 162.

[traps | informs]: Specify one of the options.

Negation: (config-snmps-host)# no host

3.9.37.6.3 (config-snmps-host)# version

Syntax: (config-snmps-host)# version { v1 [<v1_comm>] | v2 [<v2_comm>] | v3 [probe | engineID <v_word10_to_32>] [<securtname>] }

Parameters:

{ v1 [<v1_comm>] | v2 [<v2_comm>] | v3 [probe | engineID <v_word10_to_32>] [<securtname>] }: Specify one of the SNMP versions.

v1 [v1_comm]: Support SNMPv1 and trap community access string when sending SNMP trap packet. The allowed string length is 0 to 255, and the allowed content is ASCII characters from 0x21 to 0x7E.

v2 [v2_comm]: Support SNMPv2c and trap community access string when sending SNMP trap packet. The allowed string length is 0 to 255, and the allowed content is ASCII characters from 0x21 to 0x7E.

v3 [probe | engineID <v_word10_to_32>] [<securtname>]: Support SNMPv3.

[probe | engineID <v_word10_to_32>]: Indicates the SNMP trap probe security engine ID or SNMP trap security engine ID. SNMPv3 sends traps and informs use USM for authentication and privacy. A unique engine ID for these traps and informs is needed. When "Trap Probe Security Engine ID" is enabled, the ID will be probed automatically. Otherwise, the ID specified in this field is used. The string must contain an even number (in hexadecimal format) with number of digits between 10 and 64, but all-zeros and all-'F's are not allowed.

[<securtname>]: Indicates the SNMP trap security name. SNMPv3 traps and informs use USM for authentication and privacy. A unique security name is needed when traps and informs are enabled.

Explanation: Configure SNMP version and its corresponding values.

Example: Support SNMPv2c version.

```
# config t
(config-snmps-host)# version v2 public
```

Negation: (config-snmps-host)# no version

3.9.37.6.4 (config-snmps-host)# informs retries

Syntax: (config-snmps-host)# informs retries <retries> timeout <timeout>

Explanation: Configure SNMP trap retry times and timeout.

Parameters:

<retries>: Indicates the SNMP trap inform retry times. The allowed range is 0 to 255.

<timeout>: Indicates the SNMP trap inform timeout. The allowed range is 0 to 2147.

Negation: (config-snmps-host)# no informs

3.9.37.6.5 (config-snmps-host)# shutdown

Syntax: (config-snmps-host)# shutdown

Explanation: Disable the SNMP trap mode.

Example: Disable the SNMP trap mode.

```
# config t
(config-snmps-host)# shutdown
```

Negation: (config-snmps-host)# no shutdown

3.9.37.7 (config)# snmp-server location

Syntax: (config)# snmp-server location <v_line255>

Parameters:

<v_line255>: Specify the descriptive location of this device. The allowed string length is 0 – 255.

Example: Set the location to “Cabinet A22”

```
# config t
(config)# snmp-server location Cabinet A22
```

Negation: (config)# no snmp-server location

3.9.37.8 (config)# snmp-server security-to-group

Syntax: (config)# snmp-server security-to-group model { v1 | v2c | v3 } name <security_name> group <group_name>

Explanation: Configure SNMPv3 Group settings.

Parameters:

{ v1 | v2c | v3 }: Indicates the security model that this entry should belong to.

<security_name>: A string identifying the security name that this entry should belong to. The allowed string length is 1 to 32, and the allowed content is ASCII characters from 0x21 to 0x7E.

<group_name>: A string identifying the group name that this entry should belong to. The allowed string length is 1 to 32, and the allowed content is ASCII characters from 0x21 to 0x7E.

Negation: (config)# no snmp-server security-to-group model { v1 | v2c | v3 } name <security_name>

Show: # show snmp security-to-group [{ v1 | v2c | v3 } <security_name>]

3.9.37.9 (config)# snmp-server trap

Syntax: (config)# snmp-server trap <source_name> [id <filter_id>] [<oid_subtree> { include | exclude }]

Explanation: Configure SNMP trap source. A trap is sent when the filter type matches the specified one.

Parameters:

<source_name>: Specify the source name of a trap. The allowed source names are listed below:

'coldStart', 'warmStart', 'linkDown', 'linkUp', 'authenticationFailure', 'entConfigChange', 'newRoot', 'topologyChange', 'lldpRemTablesChange', 'risingAlarm', 'fallingAlarm', 'alarmTrapStatus', 'ipTrapInterfacesLink', 'psecTrapGlobalsMain', 'psecTrapInterfaces'

[id <filter_id>]: Specify a trap source filter ID. The valid values are 0~127.

<oid_subtree>: Specify subset OID for this entry.

{ include | exclude }]: Specify the filter type of this entry.

include: An optional flag to indicate a trap is sent for the given trap source is matched.

exclude: An optional flag to indicate a trap is not sent for the given trap source is matched.

Negation: (config)# no snmp-server trap <source_name> [[id <filter_id>] | [<oid_subtree> { include | exclude }]]

Show: # show snmp trap [<source_name>]

3.9.37.10 (config)# snmp-server user

Syntax: (config)# snmp-server user <username> engine-id <engineID> [{ md5 { <md5_passwd> | { encrypted <md5_passwd_encrypt> } } | sha { <sha_passwd> | { encrypted <sha_passwd_encrypt> } } } [priv { des | aes } { <priv_passwd> | { encrypted <priv_passwd_encrypt> } }]]

Explanation: Configure SNMPv3 User settings.

Parameters:

<username: word 32>: A string identifying the user name that this entry should belong to. The allowed string length is 1 to 32, and the allowed content is ASCII characters from 0x21 to 0x7E.

engine-id <engineID>: An octet string identifying the engine ID that this entry should belong to. The string must contain an even number (in hexadecimal format) with number of digits between 10 and 64, but all-zeros and all-'F's are not allowed. The SNMPv3 architecture uses the User-based Security Model (USM) for message security and the View-based Access Control Model (VACM) for access control. For the USM entry, the usmUserEngineID and usmUserName are the entry's keys. In a simple agent, usmUserEngineID is always that agent's own snmpEngineID value. The value can also take the value of the snmpEngineID of a remote SNMP engine with which this user can communicate. In other words, if user engine ID equal system engine ID then it is local user; otherwise it is a remote user.

[{ md5 { <md5_passwd> | { encrypted <md5_passwd_encrypt> } } | sha { <sha_passwd> | { encrypted <sha_passwd_encrypt> } } }]: Indicates the authentication protocol that this entry should belong to. Possible authentication protocols are:

md5 <md5_passwd>: An optional flag to indicate that this user uses MD5 authentication protocol. A string identifying the authentication password phrase. For MD5 authentication protocol, the allowed string length is 8 to 32 characters. For SHA authentication protocol, the allowed string length is 8 to 40 characters. The allowed content is ASCII characters from 0x21 to 0x7E.

encrypted <md5_passwd_encrypt>: Specify the encrypted MD5 password.

sha <sha_passwd>: An optional flag to indicate that this user uses SHA authentication protocol. A string identifying the authentication password phrase. For MD5 authentication protocol, the allowed string length is 8 to 32 characters. For SHA authentication protocol, the allowed string length is 8 to 40 characters. The allowed content is ASCII characters from 0x21 to 0x7E.

encrypted <sha_passwd_encrypt>: Specify the encrypted SHA password.

[priv { des | aes } { <priv_passwd> | { encrypted <priv_passwd_encrypt> } }]: Indicates the privacy protocol that this entry should belong to. Possible privacy protocols are:

DES: An optional flag to indicate that this user uses DES authentication protocol.

AES: An optional flag to indicate that this user uses AES authentication protocol.

<priv_passwd>: A string identifying the privacy password phrase. The allowed string length is 8 to 32, and the allowed content is ASCII characters from 0x21 to 0x7E.

encrypted <priv_passwd_encrypt>: Specify the encrypted privacy password.

Negation: (config)# no snmp-server user <username> engine-id <engineID>

Show: #show snmp user [<username> <engineID>]

3.9.37.11 (config)# snmp-server view

Syntax: (config)# snmp-server view <view_name> <oid_subtree> { include | exclude }

Explanation: Configure SNMPv3 MIB view name.

Parameters:

<view_name>: A string identifying the view name that this entry should belong to. The allowed string length is 1 to 32, and the allowed content is ASCII characters from 0x21 to 0x7E.

<oid_subtree>: The OID defining the root of the subtree to add to the named view. The allowed OID length is 1 to 128.

{ include | exclude }: Indicates the view type that this entry should belong to. Possible view types are:

included: An optional flag to indicate that this view subtree should be included.

excluded: An optional flag to indicate that this view subtree should be excluded. In general, if a view entry's view type is 'excluded', there should be another view entry existing with view type as 'included' and its OID subtree should overstep the 'excluded' view entry.

Negation: (config)# no snmp-server view <view_name> <oid_subtree>

Show: # show snmp view [<view_name> <oid_subtree>]

3.9.38 (config)# spanning-tree

3.9.38.1 (config)# spanning-tree aggregation

Syntax: (config)# spanning-tree aggregation

Explanation: Enable aggregation mode of Spanning Tree.

Example: Enter aggregation mode.

```
# config t
(config)# spanning-tree aggregation
(config-stp-aggr)#
```

Show: # show spanning-tree

3.9.38.1.1 (config-stp-aggr)# spanning-tree

Syntax: (config-stp-aggr)# spanning-tree

Explanation: Enable Spanning Tree under aggregation mode.

Negation: (config-stp-aggr)# no spanning-tree

Show: # show spanning-tree

3.9.38.1.2 (config-stp-aggr)# spanning-tree auto-edge

Syntax: (config-stp-aggr)# spanning-tree auto-edge

Explanation: Enable auto edge function. When enabled, a port is automatically determined to be at the edge of the network when it receives no BPDUs.

Negation: (config-stp-aggr)# no spanning-tree auto-edge

Show: # show spanning-tree

3.9.38.1.3 (config-stp-aggr)# spanning-tree bpdu-guard

Syntax: (config-stp-aggr)# spanning-tree bpdu-guard

Explanation: Enable BPDU guard function. This feature protects ports from receiving BPDUs. It can prevent loops by shutting down a port when a BPDU is received instead of putting it into the spanning tree discarding state. If enabled, the port will disable itself upon receiving valid BPDU's.

Negation: (config-stp-aggr)# no spanning-tree bpdu-guard

Show: # show spanning-tree

3.9.38.1.4 (config-stp-aggr)# spanning-tree edge

Syntax: (config-stp-aggr)# spanning-tree edge

Explanation: If an interface is attached to end nodes, you can set it to “Edge”.

Negation: (config-stp-aggr)# no spanning-tree edge

Show: # show spanning-tree

3.9.38.1.5 (config-stp-aggr)# spanning-tree link-type

Syntax: (config-stp-aggr)# spanning-tree link-type { point-to-point | shared | auto }

Explanation: Configure the link type attached to an interface.

Parameters:

{ point-to-point | shared | auto }: Select the link type attached to an interface.

point-to-point: It is a point-to-point connection.

shared: It is a shared medium connection

auto: The switch automatically determines whether the interface is attached to a point-to-point link or shared medium.

Negation: (config-stp-aggr)# no spanning-tree link-type

Show: # show spanning-tree

3.9.38.1.6 (config-stp-aggr)# spanning-tree mst <instance> cost

Syntax: (config-stp-aggr)# spanning-tree mst <instance> cost { <cost> | auto }

Explanation: Configure MSTI and its’ path cost value.

Parameters:

mst <instance: 0-15>: Specify MST instance number. Specify “0” to denote CIST. Specify “1-15” to denote MSTI 1-15.

cost { <cost> | auto }: Specify a Path cost value that is used to determine the best path between devices. Valid values are 1 to 200000000. If “auto” mode is specified, the system automatically detects the speed and duplex mode to decide the path cost. Please note that path cost takes precedence over port priority.

Negation: (config-stp-aggr)# no spanning-tree mst <instance> cost

Show: # show spanning-tree

3.9.38.1.7 (config-stp-aggr)# spanning-tree mst <instance> port-priority

Syntax: (config-stp-aggr)# spanning-tree mst <instance> port-priority <prio>

Explanation: Configure MSTI and its' port priority.

Parameters:

mst <instance: 0-15>: Specify MST instance number. Specify "0" to denote CIST. Specify "1-15" to denote MSTI 1-15.

port-priority <prio>: Specify a port priority value.

Negation: (config-stp-aggr)# no spanning-tree mst <instance> port-priority

Show: # show spanning-tree

3.9.38.1.8 (config-stp-aggr)# spanning-tree restricted-role

Syntax: (config-stp-aggr)# spanning-tree restricted-role

Explanation: Enable restricted role function. If enabled, this causes the port not to be selected as Root Port for the CIST or any MSTI, even if it has the best spanning tree priority.

Negation: (config-stp-aggr)# no spanning-tree restricted-role

Show: # show spanning-tree

3.9.38.1.9 (config-stp-aggr)# spanning-tree restricted-tcn

Syntax: (config-stp-aggr)# spanning-tree restricted-tcn

Explanation: Enable restricted TCN function. If enabled, this causes the port not to propagate received topology change notifications and topology changes to other ports.

Negation: (config-stp-aggr)# no spanning-tree restricted-tcn

Show: # show spanning-tree

3.9.38.2 (config)# spanning-tree edge bpdu-filter

Syntax: (config)# spanning-tree edge bpdu-filter

Explanation: Enable edge BPDU filtering function. The purpose of Port BPDU Filtering is to prevent the switch from sending BPDU frames on ports that are connected to end devices.

Example: Enable edge BPDU filtering function.

```
# config t
(config)# spanning-tree edge bpdu-filter
```

Negation: (config)# no spanning-tree edge bpdu-filter

Show: # show spanning-tree

3.9.38.3 (config)# spanning-tree edge bpdu-guard

Syntax: (config)# spanning-tree edge bpdu-guard

Explanation: Enable edge BPDU guard function. Edge ports generally connect directly to PC, file servers or printers. Therefore, edge ports are configured to allow rapid transition. Under normal situations, edge ports should not receive configuration BPDUs. However, if they do, this probably is due to malicious attacks or mis-settings. When edge ports receive configuration BPDUs, they will be automatically set to non-edge ports and start a new spanning tree calculation process.

BPDU Guard is therefore used to prevent the device from suffering malicious attacks. With this function enabled, when edge ports receive configuration BPDUs, STP disables those affected edge ports. After a period of recovery time, those disabled ports are re-activated.

Example: Enable edge BPDU guard function.

```
# config t
(config)# spanning-tree edge bpdu-guard
```

Negation: (config)# no spanning-tree edge bpdu-guard

Show: # show spanning-tree

3.9.38.4 (config)# spanning-tree mode

Syntax: (config)# spanning-tree mode { stp | rstp | mstp }

Parameters:

{ stp | rstp | mstp }: Specify one of the STP protocol versions.

Explanation: Configure the desired STP protocol version.

Example: Set the spanning tree mode to MSTP.

```
# config t
(config)# spanning-tree mode mstp
```

Negation: (config)# no spanning-tree mode

Show: # show spanning-tree

3.9.38.5 (config)# spanning-tree mst <instance> priority <prio>

Syntax: (config)# spanning-tree mst <instance> priority <prio>

Parameters:

<instance: 0-7>: Specify an instance ID. "0" means CIST. "1-7" means MSTI 1-7.

<prio: 0-61440>: Specify a priority value.

Explanation: Specify an appropriate priority for a MSTI instance. Bridge priority is used in selecting the root device, root port, and designated port. The device with the highest priority becomes the root device. However, if all devices have the same priority, the device with the lowest MAC address will then become the root device. Note that lower numeric values indicate higher priority. The bridge priority plus the MSTI instance number, concatenated with the 6-byte MAC address of the switch forms a Bridge Identifier.

Example: Map MST Instance 1 to priority 61440.

```
# config t
(config)# spanning-tree mst 1 priority 61440
```

Negation: (config)# no spanning-tree mst <instance> priority

Show: # show spanning-tree

3.9.38.6 (config)# spanning-tree mst <instance> vlan <v_vlan_list>

Syntax: (config)# spanning-tree mst <instance> vlan <v_vlan_list>

Parameters:

<instance: 0-7>: Specify an instance ID. "0" means CIST. "1-7" means MSTI 1-7.

<v_vlan_list>: Specify a list of VLANs for the specified MST instance. Separate VLANs with a comma and use hyphen to denote a range of VLANs. (Example: 2,5,20-40)

Explanation: Specify VLANs mapped to a certain MSTI. Both a single VLAN and a range of VLANs are allowed.

Example: Map MST Instance 1 to VLAN 90 and VLAN 101-105.

```
# config t
(config)# spanning-tree mst 1 vlan 90,101-105
```

Negation: (config)# no spanning-tree mst <instance> vlan

3.9.38.7 (config)# spanning-tree mst forward-time

Syntax: (config)# spanning-tree mst forward-time <fwdtime>

Parameters:

<fwdtime: 4-30>: Specify forward delay value between 4 and 30 (seconds).

Explanation: For STP bridges, the Forward Delay is the time spent in each Listening and Learning state before the Forwarding state is entered. This delay occurs when a new bridge comes onto a network.

Example: Set the forward delay to 15 seconds.

```
# config t
(config)# spanning-tree mst forward-time 15
```

Negation: (config)# no spanning-tree mst forward-time

Show: # show spanning-tree

3.9.38.8 (config)# spanning-tree mst max-age

Syntax: (config)# spanning-tree mst max-age <maxage> [forward-time <fwdtime>]

Parameters:

<maxage: 6-40>: Specify the max age value. The valid range is from 6 to 40.

[forward-time <fwdtime>]: For STP bridges, the Forward Delay is the time spent in each Listening and Learning state before the Forwarding state is entered. This delay occurs when a new bridge comes onto a network. Valid values are 4-30 seconds.

Explanation: If another switch in the spanning tree does not send out a hello packet for a period of time, it is considered to be disconnected. Valid values are 6 to 40 seconds, and Max Age values must be smaller than or equal to (Forward Delay-1)*2.

Example: Set the max age to 20 seconds.

```
# config t
(config)# spanning-tree mst max-age 20
```

Negation: (config)# no spanning-tree mst max-age

Show: # show spanning-tree

3.9.38.9 (config)# spanning-tree mst max-hops

Syntax: (config)# spanning-tree mst max-hops <maxhops>

Parameters:

<maxhops>: Specify the maximum hop count value. The valid range is from 6 to 40.

Explanation: The maximum number of hops allowed for MST region before a BPDU is discarded. Each bridge decrements the hop count by one before passing on the BPDU. When the hop count reaches zero, the BPDU is discarded. The default hop count is 20. The allowed range is 6-40.

Example: Set the maximum hop count to 20.

```
# config t
(config)# spanning-tree mst max-hops 20
```

Negation: (config)# no spanning-tree mst max-hops

Show: # show spanning-tree

3.9.38.10 (config)# spanning-tree mst name

Syntax: (config)# spanning-tree mst name <name> revision <v_0_to_65535>

Parameters:

name <name>: Specify a name for this MSTI. By default, the switch's MAC address is used. The maximum length is 32 characters. In order to share spanning trees for MSTI, bridges must have the same configuration name and revision value.

revision <v_0_to_65535>: Specify a revision number for this MSTI. The allowed range is 0 – 65535.

Explanation: Configure a name and revision number for this MSTI.

Negation: (config)# no spanning-tree mst name

Show: # show spanning-tree

3.9.38.11 (config)# spanning-tree recovery interval

Syntax: (config)# spanning-tree recovery interval <interval>

Parameters:

<interval>: The time that has to pass before a port in the error-disabled state can be enabled. The allowed range is 30 – 86400 (seconds).

Explanation: When enabled, a port that is in the error-disabled state can automatically be enabled after a certain time.

Example: Set the spanning tree recovery interval to 50.

```
# config t
(config)# spanning-tree recovery interval 50
```

Negation: (config)# no spanning-tree recovery interval

Show: # show spanning-tree

3.9.38.12 (config)# spanning-tree transmit hold-count

Syntax: (config)# spanning-tree transmit hold-count <holdcount>

Parameters:

<holdcount:1-10>: Specify the transmit hold-count. The allowed transmit hold count is 1 to 10.

Explanation: The number of BPDU sent by a bridge port per second. When exceeded, transmission of the next BPDU will be delayed. By default, it is set to 6. The allowed transmit hold count is 1 to 10. Please note that increasing this value might have a significant impact on CPU utilization and decreasing this value might slow down convergence. It is recommended to remain Transmit Hold Count to the default setting.

Example: Set the spanning tree transmit hold-count to 6.

```
# config t
(config)# spanning-tree transmit hold-count 6
```

Negation: (config)# no spanning-tree transmit hold-count

Show: # show spanning-tree

3.9.39 (config)# switchport

3.9.39.1 (config)# switchport vlan mapping <group ID> <vlan_list> <translation_vlan>

Syntax: (config)# switchport vlan mapping <group ID> <vlan_list> <translation_vlan>

Explanation: VLAN Translation is especially useful for users who want to translate the original VLAN ID to a new VLAN ID so as to exchange data across different VLANs and improve VLAN scaling. VLAN translation replaces an incoming C-VLAN tag with an S-VLAN tag instead of adding an additional tag. When configuring VLAN Translation, both ends of the link normally must be able to replace tags appropriately. In other words, both ends must be configured to translate the C-VLAN tag to S-VLAN tag and S-VLAN tag to C-VLAN tag appropriately in a network. Note that only access ports support VLAN translation. It is not recommended to configure VLAN Translation on trunk ports.

Parameters:

<group ID: 1-20>: Indicate the Group ID that applies to this translation rule.

<vlan_list>: Indicate the VLAN ID that will be mapped to a new VID.

<translation_vlan>: Indicate the new VID to which VID of ingress frames will be changed.

Example: Map the group ID 5 with VLAN ID 100 to be translated to 201.

```
# config t
(config)# switchport vlan mapping 5 100 201
```

Negation: (config)# no switchport vlan mapping <group> <v_vlan_id_from>

3.9.39.2 (config)# switchport vlan mapping <group ID> { both | ingress | egress } < vid > <translation_vlan>

Syntax: (config)# switchport vlan mapping <group ID> { both | ingress | egress } < vid > <translation_vlan>

Explanation: VLAN Translation is especially useful for users who want to translate the original VLAN ID to a new VLAN ID so as to exchange data across different VLANs and improve VLAN scaling. VLAN translation replaces an incoming C-VLAN tag with an S-VLAN tag instead of adding an additional tag. When configuring VLAN Translation, both ends of the link normally must be able to replace tags appropriately. In other words, both ends must be configured to translate the C-VLAN tag to S-VLAN tag and S-VLAN tag to C-VLAN tag appropriately in a network. Note that only access ports support VLAN translation. It is not recommended to configure VLAN Translation on trunk ports.

Parameters:

<group ID: 1-28>: Indicate the Group ID that applies to this translation rule.

{ both | ingress | egress}: Indicate the direction of the VLAN translation. The direction can be 'ingress', 'egress' or 'both'. 'Ingress' VLAN translation takes place on the VLAN ID of frames entering the switch port. On the other hand, 'Egress' VLAN translation takes places on the VLAN ID of frames leaving or exiting the switch port. 'Both' means VLAN translation takes places on both directions mentioned above.

<vid>: Indicate the VLAN ID that will be mapped to a new VID.

<translation_vlan>: Indicate the new VID to which VID of ingress frames will be changed.

Negation: (config)# no switchport vlan mapping <group ID> { both | ingress | egress } < vid > <translation_vlan>

3.9.40 (config)# tacacs-server

3.9.40.1 (config)# tacacs-server timeout

Syntax: (config)# tacacs-server timeout <seconds>

Explanation: The time the switch waits for a reply from a TACACS+ server before it retransmits the request.

Parameters:

<seconds:1-1000: Specify a value for timeout. The allowed timeout range is between 1 and 1000 seconds.

Negation: (config)# no tacacs-server timeout

Show: # show tacacs-server

3.9.40.2 (config)# tacacs-server deadtime

Syntax: (config)# tacacs-server deadtime <minutes>

Explanation: Deadtime is the period during which the switch will not send new requests to a server that has failed to respond to a previous request. This will stop the switch from continually trying to contact a server that it has already determined as dead.

Parameters:

<minutes:1-1440>: Specify a value for tacacs-server deadtime. The allowed deadtime range is between 1 to 1440 minutes.

Negation: (config)# no tacacs-server deadtime

Show: # show tacacs-server

3.9.40.3 (config)# tacacs-server key

Syntax: (config)# tacacs-server key { [unencrypted] <unencrypted_key> | encrypted <encrypted_key> }

Explanation: Specify the secret key up to 63 characters. This is shared between a TACACS+ sever and the switch.

Parameters:

{ [unencrypted] <unencrypted_key> | encrypted <encrypted_key> }: Specify a shared secret key value (either unencrypted or encrypted).

Negation: (config)# no tacacs-server key

Show: # show tacacs-server

3.9.40.4 (config)# tacacs-server host

Syntax: (config)# tacacs-server host <host_name> [port <port>] [timeout <seconds>] [key { [unencrypted] <unencrypted_key> | encrypted <encrypted_key> }]

Explanation: Configure radius server settings.

Parameters:

<host_name>: Specify a hostname or IP address for the TACACS+ server.

[port <port>]: Specify the TCP port number to be used on a TACACS+ server for authentication.

[timeout <seconds>]: If timeout value is specified here, it will replace the global timeout value. If you prefer to use the global value, leave this field blank.

[key { [unencrypted] <unencrypted_key> | encrypted <encrypted_key> }]: If secret key is specified here, it will replace the global secret key. If you prefer to use the global value, leave this field blank.

Negation: (config)# no tacacs-server host <host_name> [port <port>]

Show: # show tacacs-server

3.9.41 (config)# upnp

3.9.41.1 (config)# upnp

Syntax: (config)# upnp

Explanation: Enable upnp operation.

Example: Enable upnp operation

```
# config t
(config)# upnp
(config)#
```

Negation: (config)# no upnp

Show: # show upnp

3.9.41.2 (config)# upnp advertising-duration

Syntax: (config)# upnp advertising-duration <v_100_to_86400>

Parameters:

<v_100_to_86400>: Specify the advertising duration. The allowed range is 100 to 86400 (seconds).

Explanation: This defines how often an UPnP advertisement is sent. The duration is carried in Simple Service Discover Protocol (SSDP) packets which informs a control point how often it should receive a SSDP advertisement message from the switch. By default, the advertising duration is set to 100 seconds. However, due to the unreliable nature of UDP, it is recommended to set to the shorter duration since the shorter the duration, the fresher is UPnP status.

Example: Set the upnp advertising duration to 150 seconds.

```
# config t
(config)# upnp advertising-duration 150
```

Negation: (config)# no upnp advertising-duration

Show: # show upnp

3.9.41.3 (config)# upnp static interface vlan

Syntax: (config)# upnp static interface vlan <v_vlan_id>

Explanation: Determine IP VLAN interface for UPnP applications.

Parameters:

<v_vlan_id>: Specify a specific IP VLAN interface. It will only be applied when IP addressing mode is static.

Negation: (config)# no upnp static interface vlan

Show: # show upnp

3.9.42 (config)# username

3.9.42.1 (config)# username { default-administrator | <input_username> } privilege <priv> password encrypted

Syntax: (config)# username { default-administrator | <input_username> } privilege <priv> password { unencrypted <unencyr_password> | encrypted <encyr_password> }

Explanation: By default, there is only one user, 'admin', assigned the highest privilege level of 15. Use this command to configure a new user account.

Parameters:

username { default-administrator | <input_username>}: Specify a new username. The allowed characters are 31.

privilege <priv: 0-15>: Specify the privilege level for this new user account. The allowed range is 1 to 15. If the privilege level value is 15, it can access all groups, i.e. that is granted the fully control of the device. But other values need to refer to each group privilege level. User's privilege should be same or greater than the group privilege level to have the access of that group. By default setting, most groups privilege level 5 has the read-only access and privilege level 10 has the read-write access. And the system maintenance (software upload, factory defaults and etc.) need user privilege level 15. Generally, the privilege level 15 can be used for an administrator account, privilege level 10 for a standard user account and privilege level 5 for a guest account.

password { unencrypted <unencyr_password> | encrypted <encyr_password> | none }: Specify the unencrypted or encrypted password for this new user account. Note: The ENCRYPTED password will be decoded by system internally. You cannot directly use it as same as the Plain Text and it is not human-readable text normally.

Example: Create the new user account with the following settings.

```
# config t
(config)# username mis4jack privilege 15 password encrypted jack30125
```

Negation: (config)# no username <username>

Show: > show users
show users

3.9.42.2 (config)# username<username>privilege<priv>password none

Syntax: (config)# username <username> privilege <priv> password none

Explanation: By default, there is only one user, 'admin', assigned the highest privilege level of 15. Use this command to configure a new user account without password

Parameters:

username <username: word31>: Specify a new username. The allowed characters are 31.

privilege <priv: 0-15>: Specify the privilege level for this new user account. The allowed range is 1 to 15. If the privilege level value is 15, it can access all groups, i.e. that is granted the fully control of the device. But other values need to refer to each group privilege level. User's privilege should be same or greater than the group privilege level to have the access of that group. By default setting, most groups privilege level 5 has the read-only access and privilege level 10 has the read-write access. And the system maintenance (software upload, factory defaults and etc.) need user privilege level 15. Generally, the privilege level 15 can be used for an administrator account, privilege level 10 for a standard user account and privilege level 5 for a guest account.

password none: No password for this user account.

Example: Create the new user account with the following settings.

```
# config t
(config)# username mis4jack privilege 15 password none
```

Negation: (config)# no username <username>

Show: > show users
show users

3.9.42.3 (config)# username<username>privilege<priv>password unencrypted

Syntax: (config)# username <username> privilege <priv> password unencrypted <password>

Explanation: By default, there is only one user, 'admin', assigned the highest privilege level of 15. Use this command to configure a new user account with unencrypted password.

Parameters:

username <username: word31>: Specify a new username. The allowed characters are 31.

privilege <priv: 0-15>: Specify the privilege level for this new user account. The allowed range is 1 to 15. If the privilege level value is 15, it can access all groups, i.e. that is granted the fully control of the device. But other values need to refer to each group privilege level. User's privilege should be same or greater than the group privilege level to have the access of that group. By default setting, most groups privilege level 5 has the read-only access and privilege level 10 has the read-write access. And the system maintenance (software upload, factory defaults and etc.) need user privilege level 15. Generally, the privilege level 15 can be used for an administrator account, privilege level 10 for a standard user account and privilege level 5 for a guest account.

password unencrypted <password: line31>: Specify the unencrypted password for this user account. The UNENCRYPTED (Plain Text) user password. Any printable characters including space is accepted.

Example: Create the new user account with the following settings.

```
# config t
(config)# username mis4jack privilege 15 password unencrypted jack30125
```

Negation: (config)# no username <username>

Show: > show users
show users

3.9.43 (config)# vlan

3.9.43.1 (config)# vlan

Syntax: (config)# vlan <vlist>

Explanation: Configure allowed VLANs.

Parameters:

<vlist>: This shows the allowed access VLANs. This setting only affects ports set in “Access” mode. Ports in other modes are members of all VLANs specified in “Allowed VLANs” field. By default, only VLAN 1 is specified. More allowed access VLANs can be entered by specifying the individual VLAN ID separated by comma. If you want to specify a range, separate it by a dash. For example, 1, 5,10,12-15,100. Once Enter is pressed, the prompt changes to (config-vlan)#

Example: Add VID 1,5,10,12-15,100 to the allowed VLAN list.

```
# config t
(config)# vlan 1,5,10,12-15,100
(config-vlan)#
```

Negation: (config)# no vlan { { ethertype s-custom-port } | <vlan_list> }

3.9.43.2 (config)# vlan ethertype s-custom-port

Syntax: (config)# vlan ethertype s-custom-port <etype>

Explanation: Configure ether type used for customer s-ports.

Parameters:

ethertype s-custom-port <etype>: Specify ether type used for customer s-ports. The valid range is 0x0600 to 0xffff.

Example: Set ether type for customer s-port to 0x88a8.

```
# config t
(config)# vlan ethertype s-custom-port 0x88a8
```

Negation: (config)# no vlan { { ethertype s-custom-port } | <vlan_list> }

3.9.43.3 (config)# vlan protocol

Syntax: (config)# vlan protocol { { eth2 { <etype> | arp | ip | ipx | at } } | { snap { <oui> | rfc-1042 | snap-8021h } <pid> } | { llc <dsap> <ssap> } } group <grp_id>

Explanation: The network devices required to support multiple protocols cannot be easily grouped into a common VLAN. This may require non-standard devices to pass traffic between different VLANs in order to encompass all the devices participating in a specific protocol. This kind of configuration deprives users of the basic benefits of VLANs, including security and easy accessibility.

To avoid these problems, you can configure this switch with protocol-based VLANs that divide the physical network into logical VLAN groups for each required protocol. When a frame is received at a port, its VLAN membership can then be determined based on the protocol type being used by the inbound packets.

Parameters:

protocol { { eth2 { <etype> | arp | ip | ipx | at } } | { snap { <oui> | rfc-1042 | snap-8021h } <pid> } | { llc <dsap> <ssap> } } : There are three frame types available for selection; these are “Ethernet”, “SNAP”, and “LLC”. The value field will need to be changed accordingly.

eth2 (Ethernet): Ether Type (etype) value. By default, it is set to 0x0800. The range allowed is 0x0600 to 0xffff.

SNAP: This includes OUI (Organizationally Unique Identifier) and PID (Protocol ID) values.

OUI: A value in the format of xx-xx-xx where each pair (xx) in the string is a hexadecimal value in the ranges of 0x00-0xff.

PID: If the OUI is hexadecimal 000000, the protocol ID is the Ethernet type field value for the protocol running on top of SNAP. If the OUI is that of a particular organization, the protocol ID is a value assigned by that organization to the protocol running on top of SNAP. In other words, if value of the OUI field is 00-00-00, then value of the PID will be etherType (0x0600-0xffff), and if value of the OUI is other than 00-00-00, then valid value of the PID will be any value from 0x0000 to 0xffff.

LLC (Logical Link Control): This includes DSAP (Destination Service Access Point) and SSAP (Source Service Access Point) values. By default, the value is 0xff. Valid range is 0x00 to 0xff.

group <grp_id>: Indicate the descriptive name for this entry. This field only allows 16 alphabet characters (a-z; A-Z) or integers (0-9).

Example: Set VLAN protocol to eth2 0x88a8.

```
# config t
(config)# vlan protocol eth2 0x88a8 group a12
```

Negation: (config)# no vlan protocol { { eth2 { <etype> | arp | ip | ipx | at } } | { snap { <oui> | rfc-1042 | snap-8021h } <pid> } | { llc <dsap> <ssap> } } group <grp_id>

Show: # show vlan protocol [eth2 { <etype> | arp | ip | ipx | at }] [snap { <oui> | rfc-1042 | snap-8021h } <pid>] [llc <dsap> <ssap>]

3.9.44 (config)# web privilege group

Syntax: (config)# web privilege group <group_name> level { [cro <cro>] [crw <crw>] [sro <sro>] [srw <srw>] }*1

Explanation: Assign web privilege level to the specified group.

Parameters:

group <group_name>: This name identifies the privilege group. Valid words are Aggregation' 'DHCP' 'Dhcp_Client' 'Diagnostics' 'EEE' 'ERPS' 'Green_Ethernet' 'IP2' 'IPMC_Snooping' 'LACP' 'LLDP' 'Loop_Protect' 'MAC_Table' 'MVR' 'Maintenance' 'Mirroring' 'NTP' 'POE' 'PTP' 'Ports' 'Private_VLANS' 'QoS' 'RPC' 'SMTP' 'Security' 'Smart_Config' 'Spanning_Tree' 'System' 'Timer' 'UPnP' 'VCL' 'VLAN_Translation' 'VLANS' 'XXRP' 'u-Ring'

level { [cro <cro: 0-15>] [crw <crw: 0-15>] [sro <sro: 0-15>] [srw <srw: 0-15>] }*1: Every group has an authorization Privilege level for the following sub groups:

cro (configuration read-only): The privilege level is 1 to 15.

crw (configuration/execute read-write): The privilege level is 1 to 15.

sro (status/statistics read-only): The privilege level is 1 to 15.

srw (status/statistics read-write): The privilege level is 1 to 15.

User Privilege should be the same or greater than the authorization Privilege level to have access to that group.

Example: Assign Aggregation group to crw (configuration/execute read-write) level 15.

```
# config t
(config)# web privilege group aggregation level crw 15
(config)# exit
# show web privilege group level
```

Group Name	Privilege Level			
	CRO	CRW	SRO	SRW
Aggregation	5	15	5	10
DHCP	5	10	5	10
Dhcp_Client	5	10	5	10
Diagnostics	5	10	5	10
EEE	5	10	5	10
ERPS	5	10	5	10
Green_Ethernet	5	10	5	10
IP2	5	10	5	10
IPMC_Snooping	5	10	5	10
LACP	5	10	5	10
LLDP	5	10	5	10
Loop_Protect	5	10	5	10
MAC_Table	5	10	5	10
Maintenance	15	15	15	15
Mirroring	5	10	5	10
MVR	5	10	5	10
NTP	5	10	5	10
Ports	5	10	1	10

```
-- more --, next page: Space, continue: g, quit: ^C
```

Negation: (config)# no web privilege group <group_name> level

Show: > show web privilege group <group_name> level
show web privilege group <group_name> level

3.10 Commands in Config Interface Mode

To enter Global Config Interface Mode, you need to type the following command under "(config)#".

```
# config terminal
(config)# interface GigabitEthernet 1/1
(config-if)#
```

The example above takes Port 1 for example. If you want to configure detailed settings under Gigabit Ethernet port 5, you need to change 1/1 to 1/5.

3.10.1 (config-if)# access-list

3.10.1.1 (config-if)# access-list action

Syntax: (config-if)# access-list action { permit|deny}

Explanation: Configure a specific port's action option.

Parameters:

{ permit|deny}: Permit or deny frames on a specific port.

Show: # show access-list [interface [(<port_type> [<v_port_type_list>])]]

3.10.1.2 (config-if)# access-list logging

Syntax: (config-if)# access-list logging

Explanation: Enable a specific port's logging function.

Show: # show access-list [interface [(<port_type> [<v_port_type_list>])]]

Negation: (config-if)# no access-list logging

3.10.1.3 (config-if)# access-list mirror

Syntax: (config-if)# access-list mirror

Explanation: Enable a specific port's frames to be mirrored to a destination port.

Show: # show access-list [interface [(<port_type> [<v_port_type_list>])]]

Negation: (config-if)# no access-list mirror

3.10.1.4 (config-if)# access-list policy

Syntax: (config-if)# access-list policy <policy_id>

Parameters:

<policy_id:0-255>: Specify a policy ID that applies to this specific port.

Explanation: Apply a policy ID to a specific port.

Show: # show access-list [interface [(<port_type> [<v_port_type_list>])]]

Negation: (config-if)# no access-list policy

3.10.1.5 (config-if)# access-list port-state

Syntax: (config-if)# access-list port-state

Explanation: Enable a specific port's port state.

Negation: (config-if)# no access-list port-state

3.10.1.6 (config-if)# access-list rate-limiter

Syntax: (config-if)# access-list rate-limiter <rate_limiter_id>

Parameters:

<rate_limiter_id:1-16>: Specify a rate limiter ID to a specific port.

Explanation: Apply a rate limiter ID to a specific port.

Negation: (config-if)# no access-list rate-limiter

3.10.1.7 (config-if)# access-list shutdown

Syntax: (config-if)# access-list shutdown

Explanation: Shutdown this port when specified rules are matched.

Negation: (config-if)# no access-list shutdown

3.10.1.8 (config-if)# access-list { redirect | port-copy }

Syntax: (config-if)# access-list { redirect | port-copy } interface { <port_type> <port_type_id> | (<port_type> [<port_type_list>]) }

Parameters:

{ redirect | port-copy }: Redirect or copy this port's frames to the specified port.

interface { <port_type> <port_type_id> | (<port_type> [<port_type_list>]) }: Specify the redirect or copy port type and port list.

Explanation: Redirect or copy this port's frames to the specified port.

Negation: (config-if)# no access-list { redirect | port-copy }

3.10.2 (config-if)# aggregation group

Syntax: (config-if)# aggregation group <v_uint> mode { [active | on | passive] }

Explanation: Add this specific interface to the specified aggregation group.

Parameters:

<unit>: Specify the aggregation group ID.

{ [active | on | passive] }: Configure the specified interface to active LACP, passive LACP or static aggregation.

Negation: (config-if)# no aggregation group

Show: # show aggregation [mode]

3.10.3 (config-if)# dot1x

3.10.3.1 (config-if)# dot1x port-control

Syntax: (config-if)# dot1x port-control { force-authorized | force-unauthorized | auto | single | multi | mac-based }

Parameters:

{ force-authorized | force-unauthorized | auto | single | multi | mac-based }: Specify one of the authentication modes on the selected interfaces. This setting works only when NAS is globally enabled. The following modes are available:

force-authorized: In this mode, the switch will send one EAPOL Success frame when the port link comes up, and any client on the port will be allowed network access without authentication.

force unauthorized: In this mode, the switch will send one EAPOL Failure frame when the port link comes up, and any client on the port will be disallowed network access.

auto (Port-Based 802.1X): This mode requires a dot1x-aware client to be authorized by the authentication server. Clients that are not dot1x-aware will be denied access.

single (802.1X): In Single 802.1X, at most one supplicant can get authenticated on the port at a time. Normal EAPOL frames are used in the communication between the supplicant and the switch. If more than one supplicant is connected to a port, the one that comes first when the port's link comes up will be the first one considered. If that supplicant doesn't provide valid credentials within a certain amount of time, another supplicant will get a chance. Once a supplicant is successfully authenticated, only that supplicant will be allowed access. This is the most secure of all the supported modes. In this mode, the "Port Security" module is used to secure a supplicant's MAC address once successfully authenticated.

multi (802.1X): In Multi 802.1X, one or more supplicants can get authenticated on the same port at the same time. Each supplicant is authenticated individually and secured in the MAC table using the "Port Security" module.

mac-based: Unlike port-based 802.1X, MAC-based authentication do not transmit or receive EAPOL frames. In MAC-based authentication, the switch acts as the supplicant on behalf of clients. The initial frame (any kind of frame) sent by a client is snooped by the switch, which in turn uses the client's MAC address as both username and password in the subsequent EAP exchange with the RADIUS server. The 6-byte MAC address is converted to a string on the following form "xx-xx-xx-xx-xx-xx", that is, a dash (-) is used as separator between the lower-cased hexadecimal digits. The switch only supports the MD5-Challenge authentication method, so the RADIUS server must be configured accordingly.

Example: Set Gigabit Ethernet port 1-10's admin state to "auto"

```
# config t
(config)# interface gigabitethernet 1/1-10
(config-if)# dot1x port-control auto
```

Negation: (config-if)# no dot1x port-control

3.10.3.2 (config-if)# dot1x guest-vlan

Syntax: (config-if)# dot1x guest-vlan

Explanation: Enable the guest VLAN on the selected interfaces.

Example: Enable guest VLAN on port 1-10.

```
# config t
(config)# interface gigabitethernet 1/1-10
(config-if)# dot1x guest-vlan
```

Negation: (config-if)# no dot1x guest-vlan

3.10.3.3 (config-if)# dot1x radius-qos

Syntax: (config-if)# dot1x radius-qos

Explanation: Enable RADIUS Assigned QoS on the selected interfaces.

Example: Enable RADIUS Assigned QoS on port 1-10.

```
# config t
(config)# interface gigabitethernet 1/1-10
(config-if)# dot1x radius-qos
```

Negation: (config-if)# no dot1x radius-qos

3.10.3.4 (config-if)# dot1x radius-vlan

Syntax: (config-if)# dot1x radius-vlan

Explanation: Enable RADIUS Assigned VLAN on the selected interfaces.

Example: Enable RADIUS Assigned VLAN on port 1-10.

```
# config t
(config)# interface gigabitethernet 1/1-10
(config-if)# dot1x radius-vlan
```

Negation: (config-if)# no dot1x radius-vlan

3.10.3.5 (config-if)# dot1x re-authenticate

Syntax: (config-if)# dot1x re-authenticate

Explanation: Schedules reauthentication to whenever the quiet-period of the port runs out (EAPOL-based authentication). For MAC-based authentication, reauthentication will be attempted immediately. This command only has effect for successfully authenticated clients on the port and will not cause the clients to get temporarily unauthorized.

Show: > show dot1x statistics { eapol | radius | all } [interface (<port_type> [<v_port_type_list>])]
show dot1x statistics { eapol | radius | all } [interface (<port_type> [<v_port_type_list>])]

3.10.4 (config-if)# duplex

Syntax: (config-if)# duplex { half | full | auto [half | full] }

Explanation: Configure port's duplex mode.

Parameters:

{ half | full | auto [half | full] }: Specify the duplex mode for this specific interface.

Example: Set port 1's duplex mode to auto.

```
# config t
(config)# interface gigabitethernet 1/1-10
(config-if)# duplex auto
```

Negation: (config-if)# no duplex

Show: > show interface (<port_type> [<v_port_type_list>]) status
show interface (<port_type> [<v_port_type_list>]) status

3.10.5 (config-if)# excessive-restart

Syntax: (config-if)# excessive-restart

Explanation: Restart backoff algorithm after 16 collisions (No excessive-restart means discard frames after 16 collisions.)

Negation: (config-if)# no excessive-restart

Show: > show interface (<port_type> [<v_port_type_list>]) status
show interface (<port_type> [<v_port_type_list>]) status

3.10.6 (config-if)# flowcontrol

Syntax: (config-if)# flowcontrol { on | off }

Explanation: Enable or disable flow control for this specific interface.

Parameters:

{ on | off }: Enable or disable flow control.

Negation: (config-if)# no flowcontrol

Show: > show interface (<port_type> [<v_port_type_list>]) status
show interface (<port_type> [<v_port_type_list>]) status

3.10.7 (config-if)# frame-length-check

Syntax: (config-if)# frame-length-check

Explanation: Configures if frames with incorrect frame length in the EtherType/Length field shall be dropped. An Ethernet frame contains a field EtherType which can be used to indicate the frame payload size (in bytes) for values of 1535 and below. If the EtherType/Length field is above 1535, it indicates that the field is used as an EtherType (indicating which protocol is encapsulated in the payload of the frame). If "frame length check" is enabled, frames with payload size less than 1536 bytes are dropped, if the EtherType/Length field doesn't match the actual payload length. If "frame length check" is disabled, frames are not dropped due to frame length mismatch. Note: No drop counters count frames dropped due to frame length mismatch.

Negation: (config-if)# no frame-length-size

3.10.8 (config-if)# green-ethernet

3.10.8.1 (config-if)# green-ethernet eee

Syntax: (config-if)# green-ethernet eee

Explanation: Enable EEE (Energy-Efficient Ethernet) on the selected interface.

Negation: (config-if)# no green-ethernet eee

Show: # show green-ethernet eee [interface (<port_type> [<port_list>])]

3.10.8.2 (config-if)# green-ethernet urgent-queues

Syntax: (config-if)# green-ethernet eee urgent-queues [<urgent_queue_range_list>]

Explanation: It is possible to minimize the latency for specific frames, by mapping the frames to a specific queue (done with QoS), and then mark the queue as an urgent queue. When an urgent queue gets data to be transmitted, the circuits will be powered up at once and the latency will be reduced to the wakeup time.

Queues set will activate transmission of frames as soon as data is available. Otherwise the queue will postpone transmission until a burst of frames can be transmitted.

Parameters:

[<urgent_queue_range_list>]: Specify urgent queue range. The allowed range is from 1 to 8.

Negation: (config-if)# no green-ethernet eee urgent-queues [<urgent_queue_range_list>]

3.10.8.3 (config-if)# green-ethernet energy-detect

Syntax: (config-if)# green-ethernet energy-detect

Explanation: Enable power saving function for this specific interface when there is no link partner.

Negation: (config-if)# no green-ethernet energy-detect

Show: # show green-ethernet energy-detect [interface (<port_type> [<port_list>])]

3.10.8.4 (config-if)# green-ethernet short-reach

Syntax: (config-if)# green-ethernet short-reach

Explanation: Enable power saving for ports which is connect to link partner with short cable.

Negation: (config-if)# no green-ethernet short-reach

Show: # show green-ethernet short-reach [interface (<port_type> [<port_list>])]

3.10.9 (config-if)# gvrp

Syntax: (config-if)# gvrp

Explanation: Enable GVRP function on the specified interfaces.

Negation: (config-if)# no gvrp

3.10.10 (config-if)# ip

3.10.10.1 (config-if)# ip arp inspection check-vlan

Syntax: (config-if)# ip arp inspection check-vlan

Explanation: Enable check vlan function.

Negation: (config-if)# no ip arp inspection check-vlan

3.10.10.2 (config-if)# ip arp inspection logging

Syntax: (config-if)# ip arp inspection logging { deny | permit | all }

Explanation: Enable log function on a specific interface.

Parameters:

{ deny | permit | all }; Specify one of the log types.

Deny: Log denied entries.

Permit: Log permitted entries.

All: Log all entries.

Negation: (config-if)# no ip arp inspection logging

3.10.10.3 (config-if)# ip arp inspection trust

Syntax: (config-if)# ip arp inspection trust

Explanation: Enable trust state on the selected interfaces.

Negation: (config-if)# no ip arp inspection trust

3.10.10.4 (config-if)# ip dhcp snooping trust

Syntax: (config-if)# ip dhcp snooping trust

Explanation: Set this interface to DHCP Snooping trusted port.

Negation: (config-if)# no ip dhcp snooping trust

Show: > show ip dhcp snooping [interface (<port_type> [<in_port_list>])]
show ip dhcp snooping [interface (<port_type> [<in_port_list>])]

3.10.10.5 (config-if)# ip igmp snooping filter

Syntax: (config-if)# ip igmp snooping filter <profile_name>

Explanation: Use this command to filter specific multicast traffic on a per port basis.

Parameters:

<profile_name>: Specify the configured multicast groups that are denied on a port. When a certain multicast group is selected on a port, IGMP join reports received on a port are dropped.

Negation: (config-if)# no ip igmp snooping filter

Show: > show ip igmp snooping [vlan <v_vlan_list>] [group-database [interface (<port_type> [<v_port_type_list>])] [sfm-information]] [detail]
show ip igmp snooping [vlan <v_vlan_list>] [group-database [interface (<port_type> [<v_port_type_list>])] [sfm-information]] [detail]

3.10.10.6 (config-if)# ip igmp snooping immediate-leave

Syntax: (config-if)# ip igmp snooping immediate-leave

Explanation: Enable fast leave function on a specific port. When a leave packet is received, the switch immediately removes it from a multicast service without sending an IGMP group-specific (GS) query to that interface.

Negation: (config-if)# no ip igmp snooping immediate-leave

Show: > show ip igmp snooping [vlan <v_vlan_list>] [group-database [interface (<port_type> [<v_port_type_list>])] [sfm-information]] [detail]
show ip igmp snooping [vlan <v_vlan_list>] [group-database [interface (<port_type> [<v_port_type_list>])] [sfm-information]] [detail]

3.10.10.7 (config-if)# ip igmp snooping max-groups

Syntax: (config-if)# ip igmp snooping max-groups <throttling>

Explanation: Specify the maximum number of multicast groups that a port can join at the same time.

Parameters:

<throttling>: This field limits the maximum number of multicast groups that a port can join at the same time. When the maximum number is reached on a port, any new IGMP join reports will be dropped. By default, unlimited is selected. The allowed range can be specified is 1 to 10.

Negation: (config-if)# no ip igmp snooping max-groups

Show: > show ip igmp snooping [vlan <v_vlan_list>] [group-database [interface (<port_type> [<v_port_type_list>])] [sfm-information]] [detail]
show ip igmp snooping [vlan <v_vlan_list>] [group-database [interface (<port_type> [<v_port_type_list>])] [sfm-information]] [detail]

3.10.10.8 (config-if)# ip igmp snooping mrouter

Syntax: (config-if)# ip igmp snooping mrouter

Explanation: Set this interface to Router port. If IGMP snooping cannot locate the IGMP querier, you can manually designate a port which is connected to a known IGMP querier (i.e., a multicast router/switch). This interface will then join all the current multicast groups supported by the attached router/switch to ensure that multicast traffic is passed to all appropriate interfaces within the switch.

Negation: (config-if)# no ip igmp snooping mrouter

Show: > show ip igmp snooping mrouter [detail]
show ip igmp snooping mrouter [detail]

3.10.10.9 (config-if)# ip verify source

Syntax: (config-if)# ip verify source

Explanation: Enable IP Source Guard on this interface

Negation: (config-if)# no ip verify source

Show: > show ip verify source [interface (<port_type> [<in_port_type_list>])]
show ip verify source [interface (<port_type> [<in_port_type_list>])]

3.10.10.10 (config-if)# ip verify source limit

Syntax: (config-if)# ip verify source limit <0-2>

Explanation: Specify the maximum number of dynamic clients that can be learned on a port. The available options are 0, 1, 2. If the port mode is enabled and the maximum number of dynamic clients is equal 0, the switch will only forward IP packets that are matched in static entries for a given port.

Parameters:

<0-2>: Specify the maximum number of dynamic clients that can be learned on a port.

Negation: (config-if)# no ip verify source limit

Show: > show ip verify source [interface (<port_type> [<in_port_type_list>])]
show ip verify source [interface (<port_type> [<in_port_type_list>])]

3.10.11 (config-if)# ipv6

3.10.11.1 (config-if)# ipv6 mld snooping filter

Syntax: (config-if)# ipv6 mld snooping filter <profile_name>

Explanation: Use this command to filter specific multicast traffic on a per port basis.

Parameters:

<profile_name>: Specify the configured multicast groups that are denied on a port. When a certain multicast group is selected on a port, IGMP join reports received on a port are dropped.

Negation: (config-if)# no ipv6 mld snooping filter

Show: > show ipv6 mld snooping [vlan <v_vlan_list>] [group-database [interface (<port_type> [<v_port_type_list>])] [sfm-information]] [detail]
show ipv6 mld snooping [vlan <v_vlan_list>] [group-database [interface (<port_type> [<v_port_type_list>])] [sfm-information]] [detail]

3.10.11.2 (config-if)# ipv6 mld snooping immediate-leave

Syntax: (config-if)# ipv6 igmp snooping immediate-leave

Explanation: Enable fast leave function on a specific port. When a leave packet is received, the switch immediately removes it from a multicast service without sending an IGMP group-specific (GS) query to that interface.

Negation: (config-if)# no ipv6 mld snooping immediate-leave

Show: > show ipv6 mld snooping [vlan <v_vlan_list>] [group-database [interface (<port_type> [<v_port_type_list>])] [sfm-information]] [detail]
show ipv6 mld snooping [vlan <v_vlan_list>] [group-database [interface (<port_type> [<v_port_type_list>])] [sfm-information]] [detail]

3.10.11.3 (config-if)# ipv6 mld snooping max-groups <throttling>

Syntax: (config-if)# ipv6 mld snooping max-groups <throttling>

Explanation: Specify the maximum number of multicast groups that a port can join at the same time.

Parameters:

<throttling>: This field limits the maximum number of multicast groups that a port can join at the same time. When the maximum number is reached on a port, any new IGMP join reports will be dropped. By default, unlimited is selected. The allowed range can be specified is 1 to 10.

Negation: (config-if)# no ipv6 mld snooping max-groups

Show: > show ipv6 mld snooping [vlan <v_vlan_list>] [group-database [interface (<port_type> [<v_port_type_list>])] [sfm-information]] [detail]
show ipv6 mld snooping [vlan <v_vlan_list>] [group-database [interface (<port_type> [<v_port_type_list>])] [sfm-information]] [detail]

3.10.11.4 (config-if)# ipv6 mld snooping mrouter

Syntax: (config-if)# ipv6 mld snooping mrouter

Explanation: Set this interface to Router port. If IGMP snooping cannot locate the IGMP querier, you can manually designate a port which is connected to a known IGMP querier (i.e., a multicast router/switch). This interface will then join all the current multicast groups supported by the attached router/switch to ensure that multicast traffic is passed to all appropriate interfaces within the switch.

Negation: (config-if)# no ipv6 mld snooping mrouter

Show: > show ipv6 mld snooping [vlan <v_vlan_list>] [group-database [interface (<port_type> [<v_port_type_list>])] [sfm-information]] [detail]
> show ipv6 mld snooping mrouter [detail]
show ipv6 mld snooping [vlan <v_vlan_list>] [group-database [interface (<port_type> [<v_port_type_list>])] [sfm-information]] [detail]
show ipv6 mld snooping mrouter [detail]

3.10.12 (config-if)# l2cp

Syntax: (configure-if)# l2cp { [peer [<l2cp_peer_list>]] [forward [<l2cp_forward_list>]] [discard [<l2cp_discard_list>]] }

Parameters:

[peer [<l2cp_peer_list>]]: Redirect to CPU to allow peering depending on ECE and protocol configuration. Specify 0-15 for BPDU addresses, 16 for select All bridge address, 17-32 for GARP addresses.

[forward [<l2cp_forward_list>]]: Allow forwarding depending on ECE and protocol configuration. Specify 0-15 for BPDU addresses, 16 for select All bridge address, 17-32 for GARP addresses.

[discard [<l2cp_discard_list>]]: Allow discarding depending on ECE and protocol configuration. Specify 0-15 for BPDU addresses, 16 for select All bridge address, 17-32 for GARP addresses.

Explanation: Configure the L2CP frame handling mode for the corresponding destination MAC address (DMAC). The MAC DA range for Bridge block of protocol is 01-80-C2-00-00-00 through 01-80-C2-00-00-0F (0-15) and for GARP block

of protocol is 01-80-C2-00-00-20 through 01-80-C2-00-00-2F (17-32).

Example: Enable L2CP on interface 1 and set 01-80-C2-00-00-00 to 01-80-C2-00-00-05 to Forward mode.

```
# config t
(config)# interface GigabitEthernet 1/1
(config-if)#l2cp forward 0-5
(config-if)#
```

3.10.13 (config-if)# lacp

3.10.13.1 (config-if)# lacp

Syntax: (config-if)# lacp

Explanation: Enable LACP on this interface.

Example: Enable LACP on Fast Ethernet 1.

Negation: (config-if)# no lacp

Show: # show lacp { internal | statistics | system-id | neighbour }

Clear: # clear lacp statistics

3.10.13.2 (config-if)# lacp port-priority

Syntax: (config-if)# lacp port-priority <v_1_to_65535>

Explanation: Configure a LACP key for this interface.

Parameters:

<v_1_to_65535>: Specify a LACP port priority for this interface. The lower number means greater priority. This priority value controls which ports will be active and which ones will be in a backup role.

Negation: (config-if)# no lacp port-priority <v_1_to_65535>

Show: # show lacp { internal | statistics | system-id | neighbour }

3.10.13.3 (config-if)# lacp timeout

Syntax: (config-if)# lacp timeout { fast | slow }

Explanation: Configure timeout mode.

Parameters:

{ fast | slow }: The Timeout controls the period between BPDU transmissions. Fast will transmit LACP packets each second, while Slow will wait for 30 seconds before sending a LACP packet.

Negation: (config-if)# no lacp timeout { fast | slow }

Show: # show lacp { internal | statistics | system-id | neighbour }

3.10.14 (config-if)# lldp

3.10.14.1 (config-if)# lldp cdp-aware

Syntax: (config-if)# lldp cdp-aware

Explanation: Configures if the interface shall be CDP aware (CDP discovery information is added to the LLDP neighbor table).

Example: Set Fast Ethernet interface 1 to CDP aware.

Negation: (config-if)# no lldp cdp-aware

Show: > show lldp neighbors [interface (<port_type> [<v_port_type_list>])]
show lldp neighbors [interface (<port_type> [<v_port_type_list>])]

3.10.14.2 (config-if)# lldp med media-vlan policy-list

Syntax: (config-if)# lldp med media-vlan policy-list <v_range_list>

Explanation: To apply MED Media-VLAN policy of LLDP on this interface.

Parameters:

<v_range_list>: Assign a policy to this interface.

Negation: (config-if)# no lldp med media-vlan policy-list <v_range_list>

Show: > show lldp med media-vlan-policy [<v_0_to_31>]
show lldp med media-vlan-policy [<v_0_to_31>]

3.10.14.3 (config-if)# lldp med transmit-tlv

Syntax: (config-if)# lldp med transmit-tlv [capabilities] [location] [network-policy]

Explanation: To configure LLDP-MED TLV Type for specific interface.

Parameters:

[capabilities]: Enable transmission of the optional capabilities TLV.

[location]: Enable transmission of the optional location TLV.

[network-policy]: Enable transmission of the optional network policy TLV.

Negation: (config-if)# no lldp med transmit-tlv [capabilities] [location] [network-policy]

Show: > show lldp med media-vlan-policy [<v_0_to_31>]
show lldp med media-vlan-policy [<v_0_to_31>]

3.10.14.4 (config-if)# lldp receive

Syntax: (config-if)# lldp receive

Explanation: The switch will analyze LLDP information received from neighbours.

Negation: (config-if)# no lldp receive

Show: > show lldp statistics [interface (<port_type> [<v_port_type_list>])]
show lldp statistics [interface (<port_type> [<v_port_type_list>])]

3.10.14.5 (config-if)# lldp tlv-select

Syntax: (config-if)# lldp tlv-select { management-address | port-description | system-capabilities | system-description | system-name }

Explanation: To configure LLDP-MED TLV attributes for specific interface.

Parameters:

{ management-address | port-description | system-capabilities | system-description | system-name }:
Specify a LLDP TLV attribute. LLDP uses several attributes to discover neighbour devices. These attributes contains type, length, and value descriptions and are referred to TLVs. Details such as port description, system name, system description, system capabilities, management address can be sent from this device.

Negation: (config-if)# no lldp tlv-select { management-address | port-description | system-capabilities | system-description | system-name }

Show: > show lldp neighbors [interface (<port_type> [<v_port_type_list>])]
show lldp neighbors [interface (<port_type> [<v_port_type_list>])]

3.10.14.6 (config-if)# lldp transmit

Syntax: (config-if)# lldp transmit

Explanation: To configure LLDP Tx only mode for specific interface

Negation: (config-if)# no lldp transmit

Show: # show lldp statistics [interface (<port_type> [<v_port_type_list>])]

3.10.14.7 (config-if)# lldp trap

Syntax: (config-if)# lldp trap

Explanation: Configures if an SNMP trap shall be sent when the LLDP neighbor table changes for the interface.

Negation: (config-if)# no lldp trap

Parameters:

{ [shutdown] [log] }:
When a loop is detected on a port, the loop protection will immediately take appropriate actions. Actions will be taken include "Shutdown Port", "Shutdown Port and Log" or "Log Only".

Negation: (config-if)# no loop-protect action

Show: # show loop-protect [interface (<port_type> [<plist>])]

3.10.15 (config-if)# loop-protect

3.10.15.1 (config-if)# loop-protect

Syntax: (config-if)# loop-protect

Explanation: Enable loop protection function on this interface.

Negation: (config-if)# no loop-protect

Show: # show loop-protect [interface (<port_type> [<plist>])]

3.10.15.2 (config-if)# loop-protect action

Syntax: (config-if)# loop-protect action { [shutdown] [log] }

Explanation: Configure the action taken when loops are detected on a port.

Parameters:

{ [shutdown] [log] }: When a loop is detected on a port, the loop protection will immediately take appropriate actions. Actions will be taken include “Shutdown Port”, “Shutdown Port and Log” or “Log Only”.

Negation: (config-if)# no loop-protect action

Show: # show loop-protect [interface (<port_type> [<plist>])]

3.10.15.3 (config-if)# loop-protect tx-mode

Syntax: (config-if)# loop-protect tx-mode

Explanation: Enable a port to actively generate loop protection PDUs.

Negation: (config-if)# no loop-protect tx-mode

Show: # show loop-protect [interface (<port_type> [<plist>])]

3.10.16 (config-if)# mac address-table learning

Syntax: (config)# mac address-table learning [secure]

Explanation: Set this interface to secure mode.

Parameters:

[secure]: Only static MAC entries listed in “Static MAC Table Configuration” are learned. Others will be dropped.

NOTE: Make sure that the link used for managing the switch is added to the Static Mac Table before changing to secure learning mode, otherwise the management link is lost and can only be restored by using another non-secure port or by connecting to the switch via the serial interface.

Negation: (config-if)# no mac address-table learning [secure]

Show: > show mac address-table [conf | static | aging-time | { { learning | count } [interface (<port_type> [<v_port_type_list>])] } | { address <v_mac_addr> [vlan <v_vlan_id>] } | vlan <v_vlan_id_1> | interface (<port_type> [<v_port_type_list_1>])]
show mac address-table [conf | static | aging-time | { { learning | count } [interface (<port_type> [<v_port_type_list>])] } | { address <v_mac_addr> [vlan <v_vlan_id>] } | vlan <v_vlan_id_1> | interface (<port_type> [<v_port_type_list_1>])]

Clear: # clear mac address-table

3.10.17 (config-if)# media-type

Syntax: (config-if)# media-type { rj45 | sfp | dual }

Explanation: Configure the media type supported for this specific interface.

Parameters:

{ rj45 | sfp | dual }: The options are RJ-45, SFP, or dual (both RJ-45 & SFP are supported.).

Negation: (config-if)# no media-type

3.10.18 (config-if)# mtu

Syntax: (config-if)# mtu <max_length>

Explanation: Configure the maximum transmission unit for this specific interface.

Parameters:

<max_length: 1518-1240>: Specify the MTU. The range is 1518 to 10240 bytes.

Negation: (config-if)# no mtu

Show: # show interface (<port_type> [<v_port_type_list>]) status

3.10.19 (config-if)# mvr

3.10.19.1 (config-if)# mvr immediate-leave

Syntax: (config-if)# mvr immediate-leave

Explanation: Enable immediate leave function. When enabled, the device immediately removes a port from a multicast stream as soon as it receives leave message for that group. This option only applies to an interface configured as MVR receivers.

Example: Enable immediate leave function on port 1.

Negation: (config-if)# no mvr immediate leave

3.10.19.2 (config-if)# mvr name

Syntax: (config-if)# mvr name <mvr_name> type { source | receiver }

Explanation: Configure port role of specific MVR profile for specific interface.

Parameters:

<mvr_name>: Specify a MVR name. The maximum length of the MVR name string is 16. Both alphabets and numbers are allowed for use.

{ source | receiver }: Specify MVR port role.

source: MVR source port.

receiver: MVR receiver port.

Negation: (config-if)# no mvr name <mvr_name> type

3.10.19.3 (config-if)# mvr vlan

Syntax: (config-if)# mvr vlan <v_vlan_list> type { source | receiver }

Explanation: Configure port role of a specific MVR VLAN ID for this specific interface.

Parameters:

<v_vlan_list>: MVR Multicast VLAN list

{ source | receiver }: Specify MVR port role.

source: MVR source port.

receiver: MVR receiver port.

Negation: (config-if)# no mvr immediate leave

3.10.20 (config-if)# poe

3.10.20.1 (config-if)# poe lldp

Syntax: (config-if)# poe lldp

Explanation: When enabled, PoE parameters received through LLDP are processed. When disabled, PoE parameters received through LLDP are ignored.

Negation: (config-if)# no poe lldp

3.10.20.2 (config-if)# poe mode

Syntax: (config-if)# poe mode { standard | plus }

Explanation: Configure PoE operating mode.

Parameters:

{ standard | plus }: Specify one of the options.

standard: Enable IEEE 802.3af (Class 4 PDs limited to 15.4W).

plus: Enable IEEE 802.3at (Class 4 PDs limited to 30W).

Negation: (config-if)# no poe mode

3.10.20.3 (config-if)# poe monitor

Syntax: (config-if)# poe monitor

Explanation: Enable PoE monitor function on the specified interface.

Negation: (config-if)# no poe monitor

3.10.20.4 (config-if)# poe monitor { [host <host_name>] [interval <interval>] [retry <retry>] [action { no-action | reboot | power-off }] [waiting-time <waiting_time>] }*1

Syntax: (config-if)# poe monitor { [host <host_name>] [interval <interval>] [retry <retry>] [action { no-action | reboot | power-off }] [waiting-time <waiting_time>] }*1

Explanation: Specify the monitored PD details including PD address, interval, retry, action and waiting time.

Parameters:

{ [host <host_name>] [interval <interval>] [retry <retry>] [action { no-action | reboot | power-off }] [waiting-time <waiting_time>] }*1: Specify the monitored PD details.

[host <host_name>]: Specify a hostname or IPv4/IPv6 address.

[interval <interval>]: Specify the interval between each ping checking. Valid range is 5 to 300 seconds.

[retry [retry]]: Specify the total cycles of IP checking. The allowed range is 1 to 10.

[action { no-action | reboot | power-off }]: If PDs fails to respond ping requests sent by the switch (PSE), then the switch (PSE) can take an appropriate action specified in this command.

no-action: The switch (PSE) will not take any actions on the PD.

reboot: The switch (PSE) reboots the PD after the PD failure check.

power-off: The switch (PSE) turns off the PD after the PD failure check.

[waiting-time] : Specify the waiting time in seconds. The allowed range is 30-300 seconds.

Negation: (config-if)# no poe monitor { [host] [interval] [retry] [action] [waiting-time] } * 1

3.10.20.5 (config-if)# poe priority

Syntax: (config-if)# poe priority { low | high | critical }

Explanation: When ports or attached PDs requested more power than the power supply can provide, ports are shut down based on their priority level. The switch will start from shutting down ports that have the low priority and the highest port number.

Parameters:

{ low | high | critical } : Specify port priority for this specific interface.

Negation: (config-if)# no poe priority

3.10.20.6 (config-if)# poe schedule

Syntax: (config-if)# poe schedule

Explanation: Enable PoE port scheduling function on this specific interface.

Negation: (config-if)# no poe schedule

3.10.20.7 (config-if)# poe schedule

Syntax: (config-if)# poe schedule { [mon] [tue] [wed] [thu] [fri] [sat] [sun] }*1 { [start-time <start_hour_var>] [end-time <end_hour_var>] }*1

Explanation: Configure PoE scheduling (starting and ending time).

Parameters:

{ [mon] [tue] [wed] [thu] [fri] [sat] [sun] }*1: Specify one of the options for this rule.

{ [start-time <start_hour_var>] [end-time <end_hour_var>] }*1: Specify starting and ending time of the PoE function.

Negation: (config-if)# no poe schedule { [mon] [tue] [wed] [thu] [fri] [sat] [sun] }*1

3.10.21 (config-if)# port-security

3.10.21.1 (config-if)# port-security

Syntax: (config-if)# port-security

Explanation: Enable the port security function on the selected ports.

Example: Enable Gigabit Ethernet port 1-10's port security function.

```
# config t
(config)# interface gigabitethernet 1/1-10
(config-if)# port-security
```

Negation: (config-if)# no port-security

Show: > show port-security switch [interface (<port_type> [<v_port_type_list>])]
show port-security switch [interface (<port_type> [<v_port_type_list>])]

3.10.21.2 (config-if)# port-security maximum

Syntax: (config-if)# port-security maximum [<v_0_to_1023>]

Explanation: The maximum number of MAC addresses that can be secured on this port. The number cannot exceed 1024. If the limit is exceeded, the corresponding action is taken.

Parameters:

[<v_0_to_1023>]: Specify a value between 0 and 1023

Example: Limit Gigabit Ethernet port 1-10's MAC addresses can be learnt to 5.

```
# config t
(config)# interface gigabitethernet 1/1-10
(config-if)# port-security maximum 5
```

Negation: (config-if)# no port-security maximum

Show: > show port-security [interface (<port_type> [<v_port_type_list>])]
show port-security [interface (<port_type> [<v_port_type_list>])]

- **3.9.40.7 (config-if)# port-security maximum-violation**

Syntax: (config-if)# port-security maximum-violation [<v_1_to_1023>]

Explanation: The maximum number of MAC addresses that can be marked as violating on this port. The number cannot exceed 1023. This value is only used when Violation mode is "Restrict".

Parameters:

[<v_1_to_1023>]: Specify a value between 1 and 1023

Negation: (config-if)# no port-security maximum-violation

Show: > show port-security [interface (<port_type> [<v_port_type_list>])]
show port-security [interface (<port_type> [<v_port_type_list>])]

- **3.9.40.8 (config-if)# port-security violation**

Syntax: (config-if)# port-security violation { protect | restrict | shutdown }

Explanation: If the limit is exceeded, the specified action will take effect.

Parameters:

{ protect | restrict | shutdown }: Specify one of the actions taken when the limit is exceeded.

protect: Do not allow more than the specified limit of MAC addresses to access on a port. No action is further taken.

restrict: If Limit is reached, subsequent MAC addresses on the port will be counted and marked as violating. Such MAC addresses are removed from the MAC table when the hold time expires.

shutdown: If Limit + 1 MAC addresses is seen on the port, shut down the port. This implies that all secured MAC addresses will be removed from the port, and no new addresses will be learned. Even if the link is physically disconnected and reconnected on the port (by disconnecting the cable), the port will remain shut down. There are three ways to re-open the port:

- * Boot the switch
- * Disable and re-enable Limit Control on the port or the switch
- * Click the "Reopen" button

Negation: (config-if)# no port-security violation

Show: > show port-security [interface (<port_type> [<v_port_type_list>])]
show port-security [interface (<port_type> [<v_port_type_list>])]

3.10.22 (config-if)# priority-flowcontrol prio

Syntax: (config-if)# priority-flowcontrol prio <prio>

Explanation: When PFC (802.1Qbb Priority Flow Control) is enabled on a port then flow control on a priority level is enabled. Through the Priority field, range (one or more) of priorities can be configured, for example: '0-3,7' which equals '0,1,2,3,7'. PFC is not supported through auto negotiation. PFC and Flowcontrol cannot both be enabled on the same port.

Parameters:

<prio>: Specify the private VLAN ID.

Negation: (config-if)# no priority-flowcontrol prio
(config-if)# no priority-flowcontrol prio <0~7>

3.10.23 (config-if)# pvlan

3.10.23.1 (config-if)# pvlan

Syntax: (config-if)# pvlan <pvlan_list>

Explanation: This command is used to configure private VLANs. New Private VLANs can be added and existing VLANs can be modified. Private VLANs are based on the source port mask and there are no connections to VLANs which means that VLAN IDs and Private VLAN IDs can be identical. A port must be a member of both a VLAN and a Private VLAN to be able to forward packets. By default, all ports are VLAN unaware and members of VLAN 1 and Private VLAN 1. A VLAN unaware port can only be a member of one VLAN, but it can be a member of multiple Private VLANs.

Parameters:

<pvlan_list>: Specify the private VLAN ID.

Negation: (config-if)# no pvlan <pvlan_list>

Show: # show pvlan <pvlan_list>

3.10.23.2 (config-if)# pvlan isolation

Syntax: (config-if)# pvlan isolation

Explanation: Enable Port Isolation function on this specific interface. Port Isolation is used to prevent communications between customer ports in a same Private VLAN. The port that is isolated from others cannot forward any unicast, multicast or broadcast traffic to any other ports in the same PVLAN.

Negation: (config-if)# no pvlan isolation

Show: # show pvlan isolation [interface (<port_type> [<plist>])]

3.10.24 (config-if)# qos

3.10.24.1 (config-if)# qos class

Syntax: (config-if)# qos class <cosid>

Explanation: Configure Class of Service ID on this selecte infterface.

Parameters:

<cosid>: Specify COS value (0-7).

Negation: (config-if)# no qos class

Show: # show qos

```
# show qos [ { interface [ ( <port_type> [ <port> ] ) ] } | wred | { maps [ dscp-cos ] [ dscp-ingress-translation ] [ dscp-classify ] [ cos-dscp ] [ dscp-egress-translation ] } | storm | { qce [ <qce> ] } ]
```

3.10.24.2 (config-if)# qos cos

Syntax: (config-if)# qos cos <cos>

Explanation: Configure CoS value on this selecte infterface.

Parameters:

<cos>: Specify COS value (1-7).

Negation: (config-if)# no qos cos

Show: # show qos

```
# show qos [ { interface [ ( <port_type> [ <port> ] ) ] } | wred | { maps [ dscp-cos ] [ dscp-ingress-translation ] [ dscp-classify ] [ cos-dscp ] [ dscp-egress-translation ] } | storm | { qce [ <qce> ] } ]
```

3.10.24.3 (config-if)# qos dei

Syntax: (config-if)# qos dei <dei>

Explanation: Configure DEI (Drop Eligible Indicator) value on this selecte infterface.

Parameters:

<dei>: Specify DEI for untagged frames.

Negation: (config-if)# no qos dei

Show: # show qos

```
# show qos [ { interface [ ( <port_type> [ <port> ] ) ] } | wred | { maps [ dscp-cos ] [ dscp-ingress-translation ] [ dscp-classify ] [ cos-dscp ] [ dscp-egress-translation ] } | storm | { qce [ <qce> ] } ]
```

3.10.24.4 (config-if)# qos dpl

Syntax: (config-if)# qos dpl <dpl>

Explanation: Configure DPL value on this selected interface.

Parameters:

<dpl>: Specify the default Drop Precedence Level

Negation: (config-if)# no qos dpl

Show: # show qos

```
# show qos [ { interface [ ( <port_type> [ <port> ] ) ] } | wred | { maps [ dscp-cos ] [ dscp-ingress-translation ] [ dscp-classify ] [ cos-dscp ] [ dscp-egress-translation ] } | storm | { qce [ <qce> ] } }
```

3.10.24.1 (config-if)# qos dscp-classify

Syntax: (config-if)# qos dscp-classify { zero | selected | any }

Explanation: Configure a classification method.

Parameters:

{ zero | selected | any }: Specify a classification method.

zero: Classify if incoming DSCP is 0.

selected: Classify only selected DSCP for which classification is enabled in DSCP Translation table

any: Classify all DSCP.

Negation: (config-if)# no qos dscp-classify

Show: # show qos

```
# show qos [ { interface [ ( <port_type> [ <port> ] ) ] } | { maps [ dscp-cos ] [ dscp-ingress-translation ] [ dscp-classify ] [ cos-dscp ] [ dscp-egress-translation ] } | storm | { qce [ <qce> ] } }
```

3.10.24.2 (config-if)# qos dscp-remark

Syntax: (config-if)# qos dscp-remark { rewrite | remap | remap-dp }

Explanation: Configure port egress rewriting of DSCP values.

Parameters:

{ rewrite | remap | remap-dp }: Specify an option.

rewrite: Rewrite DSCP field with classified DSCP value.

remap: Frame with DSCP from analyzer is remapped and remarked with the remapped DSCP value. Depending on the frame's DP level, the remapped DSCP value is either taken from the DSCP Translation table, Egress Remap DP0 or DP1 field.

remap-dp: Frame with DSCP from analyzer is remapped and remarked with the remapped DSCP value. The remapped DSCP value is always taken from the DSCP Translation table, Egress Remap DPO field.

Negation: (config-if)# no qos dscp-remark

Show: # show qos
show qos [{ interface [(<port_type> [<port>])] } | { maps [dscp-cos] [dscp-ingress-translation] [dscp-classify] [cos-dscp] [dscp-egress-translation] } | storm | { qce [<qce>] }]

3.10.24.3 (config-if)# qos dscp-translate

Syntax: (config-if)# qos dscp-translate

Explanation: Configure DSCP ingress translation of QoS for specific interface.

Negation: (config-if)# no qos dscp-translate

Show: # show qos
show qos [{ interface [(<port_type> [<port>])] } | { maps [dscp-cos] [dscp-ingress-translation] [dscp-classify] [cos-dscp] [dscp-egress-translation] } | storm | { qce [<qce>] }]

3.10.24.4 (config-if)# qos map cos-tag cos

Syntax: (config-if)# qos map cos-tag cos <cos> dpl <dpl> pcp <pcp> dei <dei>

Explanation: Configure (QoS class, DP level) to (PCP, DEI) Mapping of QoS for specific interface.

Parameters:

cos <cos: 0-7>: Specify a QoS class value.

dpl <dpl:0-1>: Specify a DPL value (0 or 1).

pcp <pcp: 0-7>: Specify a PCP (Priority Code Point) value.

dei <dei: 0-1>: Specify a DEI value (0 or 1).

Negation: (config-if)# no qos map cos-tag cos <cos> dpl <dpl>

Show: # show qos
show qos [{ interface [(<port_type> [<port>])] } | wred | { maps [dscp-cos] [dscp-ingress-translation] [dscp-classify] [cos-dscp] [dscp-egress-translation] } | storm | { qce [<qce>] }]

3.10.24.5 (config-if)# qos map tag-cos pcp

Syntax: (config-if)# qos map tag-cos pcp <pcp> dei <dei> cos <cos> dpl <dpl>

Explanation: Configure (PCP, DEI) to (QoS class, DP level) Mapping of QoS for specific interface.

Parameters:

pcp <pcp: 0-7>: Specify a PCP (Priority Code Point) value.

dei <dei: 0-1>: Specify a DEI value (0 or 1).

cos <cos: 0-7>: Specify a QoS class value.

dpl <dpl:0-1>: Specify a DPL value (0 or 1).

Negation: (config-if)# no qos map tag-cos pcp <pcp> dei <dei>

Show: # show qos

```
# show qos [ { interface [ ( <port_type> [ <port> ] ) ] } | wred | { maps [ dscp-cos ] [ dscp-ingress-translation ]
[ dscp-classify ] [ cos-dscp ] [ dscp-egress-translation ] } | storm | { qce [ <qce> ] } }
```

3.10.24.6 (config-if)# qos pcp

Syntax: (config-if)# qos pcp <pcp>

Explanation: Configure PCP value for specific interface.

Parameters:

pcp <pcp: 0-7>: Specify a PCP (Priority Code Point) value.

Negation: (config-if)# no qos pcp

Show: # show qos

```
# show qos [ { interface [ ( <port_type> [ <port> ] ) ] } | wred | { maps [ dscp-cos ] [ dscp-ingress-translation ]
[ dscp-classify ] [ cos-dscp ] [ dscp-egress-translation ] } | storm | { qce [ <qce> ] } }
```

3.10.24.7 (config-if)# qos policer

Syntax: (config-if)# qos policer <rate> [fps] [flowcontrol]

Explanation: Configure PCP value for specific interface.

Parameters:

<rate>: Indicate the rate for the policer. By default, 500kbps is used. The allowed range for kbps is 1-13128147.

[fps]: Rate is fps. By default, kbps is used.

[flowcontrol]: Enable Flow Control. If flow control is enabled and the port is in flow control mode, then pause frames are sent instead of discarding frames

Negation: (config-if)# no qos policer

Show: # show qos

```
# show qos [ { interface [ ( <port_type> [ <port> ] ) ] } | wred | { maps [ dscp-cos ] [ dscp-ingress-translation ]
[ dscp-classify ] [ cos-dscp ] [ dscp-egress-translation ] } | storm | { qce [ <qce> ] } }
```

3.10.24.8 (config-if)# qos queue-policer queue

Syntax: (config-if)# qos queue-policer queue <queue> <rate>

Explanation: Configure Ingress Queue Policers Rate of QoS for specific interface.

Parameters:

<queue: 0-7>: Specify a queue or a range.

<rate: 1-13128147>: Specify Policer rate in kbps or mbps. By default, kbps is used.

Negation: (config-if)# no qos queue-policer queue <queue>

Show: # show qos

```
# show qos [ { interface [ ( <port_type> [ <port> ] ) ] } | wred | { maps [ dscp-cos ] [ dscp-ingress-translation ]
[ dscp-classify ] [ cos-dscp ] [ dscp-egress-translation ] } | storm | { qce [ <qce> ] } ]
```

3.10.24.9 (config-if)# qos queue-shaper queue

Syntax: (config-if)# qos queue-shaper queue <queue> <rate> [kbps | mbps] [excess | credit] [rate-type { line | data }]

Explanation: Configure Egress Queue Policers Rate of QoS for specific interface.

Parameters:

<queue: 0-7>: Specify a queue or a range.

<Rate: 1-13107100>: Specify shaper rate.

[kbps | mbps]: Specify the rate in kbps or mbps. The default setting is in kbps.

[rate-type { line | data }]: Specify the rate type. This can be either "line" or "data" rate type.

Negation: (config-if)# no qos queue-shaper queue <queue>

Show: # show qos

```
# show qos [ { interface [ ( <port_type> [ <port> ] ) ] } | wred | { maps [ dscp-cos ] [ dscp-ingress-translation ]
[ dscp-classify ] [ cos-dscp ] [ dscp-egress-translation ] } | storm | { qce [ <qce> ] } ]
```

3.10.24.10 config-if)# qos shaper

Syntax: (config-if)# qos shaper <rate> [kbps | mbps] [rate-type { line | data }]

Explanation: Configure Egress Queue Policers Rate of QoS for specific interface.

Parameters:

<rate: 1-13107100>: Specify shaper rate in kbps or mbps.

Negation: (config-if)# no qos shaper

Show: # show qos
 # show qos [{ interface [(<port_type> [<port>])] } | wred | { maps [dscp-cos] [dscp-ingress-translation] [dscp-classify] [cos-dscp] [dscp-egress-translation] } | storm | { qce [<qce>] }]

3.10.24.11 (config)# qos storm

Syntax: (config)# qos storm { unicast | broadcast | unknown } <rate> [fps | kfps | kbps | mbps]

Explanation: Configure broadcast storm control rate for QoS

Parameters:

{ unicast | multicast | broadcast }: Specify the storm type that you want to configure.

<rate>: Specify QoS storm frame rate.

[fps | kfps | kbps | mbps]: Specify the unit for the QoS storm frame rate.

Example: The following example sets broadcast storm control for QoS to 1024 kfps.

```
# config t
(config)# qos storm broadcast 1024 kfps
```

Negation: (config)# no qos storm { unicast | multicast | broadcast }

Show: # show qos storm

3.10.24.12 (config-if)# qos tag-remark

Syntax: (config-if)# qos tag-remark { pcp <pcp> dei <dei> | mapped }

Explanation: Configure the appropriate remarking mode used by this port.

Parameters:

{ pcp <pcp> dei <dei> | mapped }: Specify a remarking mode.

pcp <pcp> dei <dei>: Specify PCP and DEI value.

mapped: Use the mapping of the classified QoS class values and DP levels to PCP/DEI values.

Negation: (config-if)# no qos tag-remark

Show: # show qos
 # show qos [{ interface [(<port_type> [<port>])] } | wred | { maps [dscp-cos] [dscp-ingress-translation] [dscp-classify] [cos-dscp] [dscp-egress-translation] } | storm | { qce [<qce>] }]

Show: # show qos
 # show qos [{ interface [(<port_type> [<port>])] } | wred | { maps [dscp-cos] [dscp-ingress-translation]
 [dscp-classify] [cos-dscp] [dscp-egress-translation] } | storm | { qce [<qce>] }]

3.10.25 (config-if)# rmon

3.10.25.1 (config-if)# rmon collection history

Syntax: (config-if)# rmon collection history <id> [buckets <buckets>] [interval <interval>]

Explanation: RMON History Configuration is to collect statistics on a physical interface to monitor network utilization, packet types, and errors. A RMON historical record can be used to monitor intermittent problems.

Parameters:

<id>: Specify an ID index. The range is 1~65535.

[buckets <buckets>]: The number of buckets requested for this entry. The allowed range is 1~65535.

[interval <interval>]: Indicates the polling interval. By default, 1800 seconds is specified. The allowed range is 1~3600 seconds.

Negation: (config-if)# no rmon collection history <id>

Show: # show rmon history [<id_list>]

3.10.25.2 (config-if)# rmon collection stats

Syntax: (config-if)# rmon collection stats <id>

Explanation: Configure RMON Statistics table using this command.

Parameters:

<id>: Specify an ID index. The range is 1~65535.

Negation: (config-if)# no rmon collection stats <id>

Show: # show rmon statistics [<id_list>]

3.10.26 (config-if)# shutdown

Syntax: (config-if)# shutdown

Explanation: Shutdown this specific interface.

Negation: (config-if)# no shutdown

Show: # show interface (<port_type> [<v_port_type_list>]) status

3.10.27 (config-if)# spanning-tree

3.10.27.1 (config-if)# spanning-tree

Syntax: (config-if)# spanning-tree

Explanation: Enable Spanning Tree on this interface.

Negation: (config-if)# no spanning-tree

Show: # show spanning-tree

3.10.27.2 (config-if)# spanning-tree auto-edge

Syntax: (config-if)# spanning-tree auto-edge

Explanation: Enable auto edge function on this interface. When enabled, a port is automatically determined to be at the edge of the network when it receives no BPDUs.

Negation: (config-if)# no spanning-tree auto-edge

Show: # show spanning-tree

3.10.27.3 (config-if)# spanning-tree bpdu-guard

Syntax: (config-if)# spanning-tree bpdu-guard

Explanation: Enable BPDU guard function on this interface. This feature protects ports from receiving BPDUs. It can prevent loops by shutting down a port when a BPDU is received instead of putting it into the spanning tree discarding state. If enabled, the port will disable itself upon receiving valid BPDU's.

Negation: (config-if)# no spanning-tree bpdu-guard

Show: # show spanning-tree

3.10.27.4 (config-if)# spanning-tree edge

Syntax: (config-if)# spanning-tree edge

Explanation: If an interface is attached to end nodes, you can set it to "Edge".

Negation: (config-if)# no spanning-tree edge

Show: # show spanning-tree

3.10.27.5 (config-if)# spanning-tree link-type

Syntax: (config-if)# spanning-tree link-type { point-to-point | shared | auto }

Explanation: Configure the link type attached to an interface.

Parameters:

{ point-to-point | shared | auto }: Select the link type attached to an interface.

point-to-point: It is a point-to-point connection.

shared: It is a shared medium connection

auto: The switch automatically determines whether the interface is attached to a point-to-point link or shared medium.

Negation: (config-if)# no spanning-tree link-type

Show: # show spanning-tree

3.10.27.6 (config-if)# spanning-tree mst <instance> cost

Syntax: (config-if)# spanning-tree mst <instance> cost { <cost> | auto }

Explanation: Configure MSTI and its' path cost value.

Parameters:

mst <instance: 0-15>: Specify MST instance number. Specify "0" to denote CIST. Specify "1-15" to denote MSTI 1-15.

cost { <cost> | auto }: Specify a Path cost value that is used to determine the best path between devices. Valid values are 1 to 200000000. If "auto" mode is specified, the system automatically detects the speed and duplex mode to decide the path cost. Please note that path cost takes precedence over port priority.

Negation: (config-if)# no spanning-tree mst <instance> cost

Show: # show spanning-tree

3.10.27.7 (config-if)# spanning-tree mst <instance> port-priority

Syntax: (config-if)# spanning-tree mst <instance> port-priority <prio>

Explanation: Configure MSTI and its' port priority.

Parameters:

mst <instance: 0-15>: Specify MST instance number. Specify "0" to denote CIST. Specify "1-15" to denote MSTI 1-15.

port-priority <prio>: Specify a port priority value.

Negation: (config-if)# no spanning-tree mst <instance> port-priority

Show: # show spanning-tree

3.10.27.8 (config-if)# spanning-tree restricted-role

Syntax: (config-if)# spanning-tree restricted-role

Explanation: Enable restricted role function. If enabled, this causes the port not to be selected as Root Port for the CIST or any MSTI, even if it has the best spanning tree priority.

Negation: (config-if)# no spanning-tree restricted-role

Show: # show spanning-tree

3.10.27.9 (config-if)# spanning-tree restricted-tcn

Syntax: (config-if)# spanning-tree restricted-tcn

Explanation: Enable restricted TCN function. If enabled, this causes the port not to propagate received topology change notifications and topology changes to other ports.

Negation: (config-if)# no spanning-tree restricted-tcn

Show: # show spanning-tree

3.10.28 (config-if)# speed

Syntax: (config-if)# speed { 10 | 100 | 1000 | 2500 | 5g | 10g | 25g | auto { [10] [100] [1000] [2500] [5g] [10g] [no-hdx] | [no-fdx] } }

Explanation: Configure port speed for this specific interface.

Negation: (config-if)# no speed

Show: # show interface (<port_type> [<v_port_type_list>]) status

3.10.29 (config-if)# switchport

3.10.29.1 (config-if)# switchport access vlan

Syntax: (config-if)# switchport access vlan <pvid>

Explanation: Configure access VLAN ID for this interface.

Parameters:

```
# config t
(config)# interface FastEthernet 1/1
(config-if)# switchport access vlan 10
(config-if)#
```

Negation: (config-if)# no switchport access vlan

Show: # show vlan status

3.10.29.2 (config-if)# switchport forbidden vlan

Syntax: (config-if)# switchport forbidden vlan { add | remove } <vlan_list>

Explanation: Add or remove a port from the forbidden VLAN list.

Parameters:

{ add | remove }: Add or remove this specific interface from the forbidden VLAN list.

<vlan_list>: Specify the VLAN ID.

Negation: (config-if)# no switchport access vlan

Show: > show switchport forbidden [{ vlan <vid> } | { name <name> }]
show switchport forbidden [{ vlan <vid> } | { name <name> }]

3.10.29.3 (config-if)# switchport hybrid acceptable-frame-type

Syntax: (config-if)# switchport hybrid acceptable-frame-type { all | tagged | untagged }

Explanation: Configure the accepted frame types. Available options include “all” (accept all frames), “tagged” (accept only tagged frames), “untagged” (accept only untagged frames). This parameter affects VLAN ingress processing. If the port only accepts tagged frames, untagged frames received on the port are discarded. By default, frame type is set to All.

Parameters:

{ all | tagged | untagged }: Specify the frame type for this interface. Available options include “all” (accept all frames), “tagged” (accept only tagged frames), “untagged” (accept only untagged frames).

Negation: (config-if)# no switchport hybrid acceptable-frame-type

Show: # show vlan status

3.10.29.4 (config-if)# switchport hybrid allowed vlan

Syntax: (config-if)# switchport hybrid allowed vlan { all | none | [add | remove | except] <vlan_list> }

Explanation: Configure allowed VLANs when this interface is in hybrid mode.

Parameters:

{ all | none | [add | remove | except] <vlan_list> }: Specify one of the options.

all: All VLANs.

none: No VLANs.

add: Add VLANs to the current list.

remove: Remove VLANs from the current list

except: All VLANs except the following specified in <vlan_list>.

<vlan_list>: Specify the VLAN list.

Negation: (config-if)# no switchport hybrid allowed vlan

Show: # show vlan status

3.10.29.5 (config-if)# switchport hybrid egress-tag

Syntax: (config-if)# switchport hybrid egress-tag { none | all [except-native] }

Explanation: Determines egress tagging of a port.

Parameters:

{ none | all [except-native] }: Determines egress tagging of a port.

none: All VLANs are untagged.

all: All VLANs are tagged.

all [except-native]: All VLANs except the configured PVID will be tagged.

Negation: (config-if)# no switchport hybrid egress-tag

Show: # show vlan status

3.10.29.6 (config-if)# switchport hybrid ingress-filtering

Syntax: (config-if)# switchport hybrid ingress-filtering

Explanation: Enable ingress filtering function on this specific interface. If Ingress Filtering is enabled and the ingress port is not a member of a VLAN, the frame from the ingress port is discarded. By default, ingress filtering is disabled.

Negation: (config-if)# no switchport hybrid ingress-filtering

Show: # show vlan status

3.10.29.7 (config-if)# switchport hybrid native vlan

Syntax: (config-if)# switchport hybrid native vlan <pvid>

Explanation: Configures the VLAN identifier in Hybrid mode for the port. The allowed values are from 1 through 4095. The default value is 1.

Parameters:

<pvid>: Specify the port VLAN ID for this specific interface.

Negation: (config-if)# no switchport hybrid native vlan

Show: # show vlan status

3.10.29.8 (config-if)# switchport hybrid port-type

Syntax: (config-if)# switchport hybrid port-type { unaware | c-port | s-port | s-custom-port }

Explanation: Configures the port type in Hybrid mode for the port.

Parameters:

{ unaware | c-port | s-port | s-custom-port }: There are four port types available. Each port type's ingress and egress action is described in the following table.

Action Port Type	Ingress Action	Egress Action
Unaware	When a tagged frame is received on a port, 1. If the tagged frame with TPID=0x8100, it becomes a double-tag frame and is forwarded. 2. If the TPID of tagged frame is not 0x8100 (ex. 0x88A8), it will be discarded.	The TPID of frame transmitted by Unaware port will be set to 0x8100. The final status of the frame after egressing are also affected by egress rule.
	When an untagged frame is received on a port, a tag (PVID) is attached and then forwarded.	
C-port	When a tagged frame is received on a port, 1. If a tagged frame with TPID=0x8100, it is forwarded. 2. If the TPID of tagged frame is not 0x8100 (ex. 0x88A8), it will be discarded.	The TPID of frame transmitted by C-port will be set to 0x8100.
	When an untagged frame is received on a port, a tag (PVID) is attached and then forwarded.	
S-port	When a tagged frame is received on a port, 1. If a tagged frame with TPID=0x88A8, it is forwarded. 2. If the TPID of tagged frame is not 0x88A8 (ex. 0x8810), it will be discarded.	The TPID of frame transmitted by S-port will be set to 0x88A8
	When an untagged frame is received on a port, a tag (PVID) is attached and then forwarded.	
S-custom port	When a tagged frame is received on a port, 1. If a tagged frame with TPID=0x88A8, it is forwarded. 2. If the TPID of tagged frame is not 0x88A8 (ex. 0x8810), it will be discarded.	The TPID of frame transmitted by S-custom-port will be set to a self-customized value, which can be set by the user using the column of Ethertype for Custom S-ports.
	When an untagged frame is received on a port, a tag (PVID) is attached and then forwarded.	

Negation: (config-if)# no switchport hybrid port-type

Show: # show vlan status

3.10.29.9 (config-if)# switchport mode

Syntax: (config-if)# switchport mode { access | trunk | hybrid }

Explanation: Configure VLAN mode for this specific interface.

Parameters:

{ access | trunk | hybrid }: Specify the VLAN mode.

Negation: (config-if)# no switchport mode

Show: # show vlan status

3.10.29.10 (config-if)# switchport trunk allowed vlan

Syntax: (config-if)# switchport trunk allowed vlan { all | none | [add | remove | except] <vlan_list> }

Explanation: Configure allowed VLANs when this interface is in trunk mode.

Parameters:

{ all | none | [add | remove | except] <vlan_list> }: Specify one of the options.

all: All VLANs.

none: No VLANs.

add: Add VLANs to the current list.

remove: Remove VLANs from the current list

except: All VLANs except the following specified in <vlan_list>.

<vlan_list>: Specify the VLAN list.

Negation: (config-if)# no switchport trunk allowed vlan

Show: # show vlan status

3.10.29.11 (config-if)# switchport trunk native vlan

Syntax: (config-if)# switchport trunk native vlan <pvid>

Explanation: Configure native VLAN ID in trunk mode for this specific interface.

Parameters:

<pvid>: Specify the port VLAN ID for this specific interface.

Negation: (config-if)# no switchport trunk native vlan

Show: # show running-config

3.10.29.12 (config-if)# switchport trunk vlan tag native

Syntax: (config-if)# switchport trunk vlan tag native

Explanation: Configure this specific interface to tag native VLAN traffic.

Negation: (config-if)# no switchport trunk vlan tag native

3.10.29.13 (config-if)# switchport vlan ip-subnet id

Syntax: (config-if)# switchport vlan ip-subnet id <vce_id> <ipv4> vlan <vid>

Explanation: IP Subnet-based VLAN configuration is to map untagged ingress frames to a specific VLAN if the source address is found in the IP subnet-to-VLAN mapping table. When IP subnet-based VLAN classification is enabled, the source address of untagged ingress frames are checked against the IP subnet-to-VLAN mapping table. If an entry is found for that subnet, these frames are assigned to the VLAN indicated in the entry. If no IP subnet is matched, the untagged frames are classified as belonging to the receiving port's VLAN ID (PVID).

Parameters:

<vce_id>: Specify index of the entry. Valid range is 1~128.

<ipv4>: Specify IP address and subnet mask. The format is xx.xx.xx.xx/mm.mm.mm.mm.

<vid>: Indicate the VLAN ID.

Negation: (config-if)# no switchport vlan ip-subnet id <vce_id_list>

Show: # show vlan ip-subnet [id <subnet_id>]

3.10.29.14 (config-if)# switchport vlan mac

Syntax: (config-if)# switchport vlan mac <mac_addr> vlan <vid>

Explanation: This command is to set up VLANs based on source MAC addresses. When ingress untagged frames are received by a port, source MAC address is processed to decide which VLAN these untagged frames belong. When source MAC addresses does not match the rules created, untagged frames are assigned to the receiving port's native VLAN ID (PVID).

Parameters:

<mac_addr>: Indicate the source MAC address. Please note that the source MAC address can only map to one VLAN ID.

vlan <vid>: Map this MAC address to the associated VLAN ID.

Negation: (config-if)# no switchport vlan mac <mac_addr> vlan <vid>

Show: # show vlan mac [address <mac_addr>]

3.10.29.15 (config-if)# switchport vlan mapping

Syntax: (config-if)# switchport vlan mapping <group>

Explanation: Configure group VLAN mapping table for this specific interface.

Parameters:

<group: 1-20>: Indicate the Group ID that applies to this rule.

Negation: (config-if)# no switchport vlan mapping

3.10.29.16 (config-if)# switchport vlan protocol group

Syntax: (config-if)# switchport vlan protocol group <grp_id> vlan <vid>

Explanation: Configure VLAN protocol group for this specific interface.

Parameters:

<grp_id: word 16>: Indicate the descriptive name for this entry. This field only allows 16 alphabet characters (a-z; A-Z) or integers (0-9).

<vid>: Specify the VLAN ID that applies to this rule.

Negation: (config-if)# no switchport vlan protocol group <grp_id> vlan <vid>

Show: # show vlan protocol [eth2 { <etype> | arp | ip | ipx | at }] [snap { <oui> | rfc-1042 | snap-8021h } <pid>] [llc <dsap> <ssap>]

3.10.30 (config-if)# vcl

Syntax: (config-if)# vcl { dmacdip | smacsip }

Explanation: Configure VCL matching based on destination MAC/IP or source MAC/IP.

Parameters:

{ dmacdip | smacsip } : VCL matching based on destination MAC/IP or source MAC/IP.

Negation: (config)# no vcl { dmacdip | smacsip }

Show: # show running-config interface (<port_type> [<list>])

3.11 Commands in Config Interface VLAN Mode

To enter Config Interface VLAN Mode, you need to type the following command under "(config)#":

```
# config terminal
(config)# interface vlan 1
(config-if-vlan)#
```

NOTE: VLAN ID used in the above example can be changed to the one applicable to your actual settings.

3.11.1 (config-if-vlan)# ip

3.11.1.1 (config-if-vlan)# ip address

Syntax: (config-if-vlan)# ip address { { <address> <netmask> } | { dhcp [fallback <fallback_address> <fallback_netmask> [timeout <fallback_timeout>]] } }

Explanation: Configure IPv4 address for this VLAN interface.

Parameters:

<address> <netmask>: Specify IPv4 address and subnet mask.

dhcp [fallback <fallback_address> <fallback_netmask> [timeout <fallback_timeout>]]: Use DHCP server to automatically assign IP address.

fallback <fallback_address> <fallback_netmask>: specify Fallback IP address and subnet mask.

timeout <fallback_timeout>: Specify Fallback timeout value.

Negation: (config-if-vlan)# no ip address

Show: > show ip interface brief
show ip interface brief

3.11.1.2 (config-if-vlan)# ip dhcp server

Syntax: (config-if-vlan)# ip dhcp server

Explanation: Enable DHCP server on this specific VLAN.

Negation: (config-if-vlan)# no ip dhcp server

Show: > show ip dhcp server
show ip dhcp server

3.11.1.3 (config-if-vlan)# ip igmp snooping

Syntax: (config-if-vlan)# ip igmp snooping

Explanation: Enable IGMP Snooping on this specific VLAN.

Negation: (config-if-vlan)# no ip igmp snooping

Show: > show ip statistics [system] [interface vlan <v_vlan_list>] [icmp] [icmp-msg <type>]
show ip statistics [system] [interface vlan <v_vlan_list>] [icmp] [icmp-msg <type>]

3.11.1.4 (config-if-vlan)# ip igmp snooping compatibility

Syntax: (config-if-vlan)# ip igmp snooping compatibility { auto | v1 | v2 | v3 }

Explanation: Configure IGMP Snooping version used for this specific VLAN.

Parameters:

{ auto | v1 | v2 | v3 }: Specify one of the IGMP Snooping options.

auto: Compatible with Version 1, Version 2, and Version 3.

v1: Compatible with IGMP version 1.

v2: Compatible with IGMP version 2.

v3: Compatible with IGMP version 3.

Negation: (config-if-vlan)# no ip igmp snooping compatibility

3.11.1.5 (config-if-vlan)# ip igmp snooping last-member-query-interval

Syntax: (config-if-vlan)# ip igmp snooping last-member-query-interval <ipmc_lmqi>

Explanation: LMQI stands for Last Member Query Interval and is to configure the maximum time to wait for IGMP/MLD report memberships on a receiver port before removing the port from multicast group membership. The allowed range is 0~31744 tenths of a second.

Parameters:

<ipmc_lmqi: 0-31744>: Specify LMQI (Last Member Query Interval) value.

Negation: (config-if-vlan)# no ip igmp snooping last-member-query-interval

3.11.1.6 (config-if-vlan)# ip igmp snooping priority

Syntax: (config-if-vlan)# ip igmp snooping priority <cos_priority>

Explanation: Specify the priority for transmitting IGMP/MLD control frames. By default, priority is set to 0. Allowed priority values is 0 -7.

Parameters:

<cos_priority: 0-7>: Specify COS for this specific VLAN. The valid range is 0 to 7.

Negation: (config-if-vlan)# no ip igmp snooping priority

3.11.1.7 (config-if-vlan)# ip igmp snooping querier address

Syntax: (config-if-vlan)# ip igmp snooping querier address <v_ipv4_ucast>

Explanation: Specify IGMP Snooping querier IP address.

Parameters:

<v_ipv4_ucast>: Specify IGMP Snooping querier unicast IP address.

Negation: (config-if-vlan)# no ip igmp snooping querier address

3.11.1.8 (config-if-vlan)# ip igmp snooping querier election

Syntax: (config-if-vlan)# ip igmp snooping querier election

Explanation: Enable IGMP Snooping querier election function.

Negation: (config-if-vlan)# no ip igmp snooping querier election

3.11.1.9 (config-if-vlan)# ip igmp snooping query-interval

Syntax: (config-if-vlan)# ip igmp snooping query-interval <ipmc_qi>

Explanation: Specify IPMC Query interval value.

Parameters:

<ipmc_qi: 1-31744>: Specify IPMC Query interval value. The valid value is 1~31744.

Negation: (config-if-vlan)# no ip igmp snooping query-interval

3.11.1.10 (config-if-vlan)# ip igmp snooping query-max-response-time

Syntax: (config-if-vlan)# ip igmp snooping query-max-response-time <ipmc_qri>

Explanation: Specify IPMC Query Response time value.

Parameters:

<ipmc_qri>: Specify IPMC Query Response time value. The valid value is 1~31744.

Negation: (config-if-vlan)# no ip igmp snooping query-max-response-time

3.11.1.11 (config-if-vlan)# ip igmp snooping robustness-variable

Syntax: (config-if-vlan)# ip igmp snooping robustness-variable <ipmc_rv>

Explanation: The robustness variable (RV) allows tuning for the expected packet loss on a subnet. If a subnet is susceptible to packet loss, this value can be increased. The RV value must not be zero and should not be one. The value should be 2 or greater. By default, it is set to 2.

Parameters:

<ipmc_rv: 1-255>: Specify IPMC Robustness Variable value. The valid value is 1~255.

Negation: (config-if-vlan)# no ip igmp snooping robustness-variable

3.11.1.12 (config-if-vlan)# ip igmp snooping unsolicited-report-interval

Syntax: (config-if-vlan)# ip igmp snooping unsolicited-report-interval <ipmc_uri>

Explanation: The Unsolicited Report Interval is the amount of time that the upstream interface should transmit unsolicited IGMP reports when report suppression/proxy reporting is enabled. The allowed range for URI is 0 -31744 seconds.

Parameters:

<ipmc_uri: 0-31744>: Specify Unsolicited Report Interval value. The valid value is 0~31744.

Negation: (config-if-vlan)# no ip igmp snooping unsolicited-report-interval

3.11.2 (config-if-vlan)# ipv6

3.11.2.1 (config-if-vlan)# ipv6 address

Syntax: (config-if-vlan)# ipv6 address <subnet>

Explanation: Configure IPv6 address for this VLAN interface.

Parameters:

<subnet>: Specify IPv6 address in X:X:X:X/<0-128> format.

Negation: (config-if-vlan)# no ipv6 address [<ipv6_subnet>]

Show: > show ip interface brief
> show ipv6 interface [vlan <v_vlan_list> { brief | statistics }]
show ip interface brief
show ipv6 interface [vlan <v_vlan_list> { brief | statistics }]

3.11.2.2 (config-if-vlan)# ipv6 address {autoconfig | dhcp | rapid-commit}}

Syntax: (config-if-vlan)# ipv6 address {autoconfig | dhcp | rapid-commit}

Explanation: Configure how IPv6 address is obtained .

Parameters:

{autoconfig | dhcp | rapid-commit}: Manual configure IPv6 address or use DHCP server to obtain IPv6 address. Or configure DHCPv6 to support rapid commit option (DHCPv6 option 14). When rapid commit is enabled, the server recognizes the Rapid Commit option in Solicit messages sent from the DHCPv6 client. The server and client then use a two-message exchange (Solicit and Reply) to configure clients, rather than the default four-message exchange (Solicit, Advertise, Request, and Reply). The two-message exchange provides faster client configuration, and is beneficial in environments in which networks are under a heavy load.

Negation: (config-if-vlan)# no ipv6 address {autoconfig | dhcp | rapid-commit}

Show: > show ipv6 interface [vlan <v_vlan_list> { brief | statistics }]
show ipv6 dhcp-client [interface vlan <v_vlan_list>]
#show ipv6 interface [vlan <v_vlan_list> { brief | statistics }]

3.11.2.3 (config-if-vlan)# ipv6 mld snooping

Syntax: (config-if-vlan)# ipv6 mld snooping

Explanation: Enable MLD (Multicast Listener Discovery) Snooping on this specific VLAN.

Negation: (config-if-vlan)# no ipv6 mld snooping

Show: > show ipv6 statistics [system] [interface vlan <v_vlan_list>] [icmp] [icmp-msg <type>]
show ipv6 statistics [system] [interface vlan <v_vlan_list>] [icmp] [icmp-msg <type>]

3.11.2.4 (config-if-vlan)# ipv6 mld snooping compatibility

Syntax: (config-if-vlan)# ipv6 mld snooping compatibility { auto | v1 | v2 }

Explanation: Configure MLD Snooping version used for this specific VLAN.

Parameters:

{ auto | v1 | v2 | v3 }: Specify one of the MLD Snooping options.

auto: Compatible with Version 1, Version 2.

v1: Compatible with MLD version 1.

v2: Compatible with MLD version 2.

Negation: (config-if-vlan)# no ipv6 mld snooping compatibility

3.11.2.5 (config-if-vlan)# ipv6 mld snooping last-member-query-interval

Syntax: (config-if-vlan)# ipv6 mld snooping last-member-query-interval <ipmc_lmqi>

Explanation: LMQI stands for Last Member Query Interval and is to configure the maximum time to wait for IGMP/MLD report memberships on a receiver port before removing the port from multicast group membership. The allowed range is 0~31744 tenths of a second.

Parameters:

<ipmc_lmqi: 0-31744>: Specify LMQI (Last Member Query Interval) value.

Negation: (config-if-vlan)# no ipv6 mld snooping last-member-query-interval

3.11.2.6 (config-if-vlan)# ipv6 mld snooping priority <cos_priority>

Syntax: (config-if-vlan)# ipv6 mld snooping priority <cos_priority>

Explanation: Specify the priority for transmitting IGMP/MLD control frames. By default, priority is set to 0. Allowed priority values is 0 -7.

Parameters:

<cos_priority: 0-7>: Specify COS for this specific VLAN. The valid range is 0 to 7.

Negation: (config-if-vlan)# no ipv6 mld snooping priority

3.11.2.7 (config-if-vlan)# ipv6 mld snooping querier election

Syntax: (config-if-vlan)# ipv6 mld snooping querier election

Explanation: Enable MLD Snooping querier election function.

Negation: (config-if-vlan)# no ipv6 mld snooping querier election

3.11.2.8 (config-if-vlan)# ipv6 mld snooping query-interval <ipmc_qi>

Syntax: (config-if-vlan)# ipv6 mld snooping query-interval <ipmc_qi>

Explanation: Specify MLD Query interval value.

Parameters:

<ipmc_qi: 1-31744>: Specify IPMC Query interval value. The valid value is 1~31744.

Negation: (config-if-vlan)# no ipv6 mld snooping query-interval

3.11.2.9 (config-if-vlan)# ipv6 mld snooping query-max-response-time <ipmc_qri>

Syntax: (config-if-vlan)# ipv6 mld snooping query-max-response-time <ipmc_qri>

Explanation: Specify MLD Query Response time value.

Parameters:

<ipmc_qri>: Specify MLD Query Response time value. The valid value is 1~31744.

Negation: (config-if-vlan)# no ipv6 mld snooping query-max-response-time

3.11.2.10 (config-if-vlan)# ipv6 mld snooping robustness-variable <ipmc_rv>

Syntax: (config-if-vlan)# ipv6 mld snooping robustness-variable <ipmc_rv>

Explanation: The robustness variable (RV) allows tuning for the expected packet loss on a subnet. If a subnet is susceptible to packet loss, this value can be increased. The RV value must not be zero and should not be one. The value should be 2 or greater. By default, it is set to 2.

Parameters:

<ipmc_rv: 1-255>: Specify IPMC Robustness Variable value. The valid value is 1~255.

Negation: (config-if-vlan)# no ipv6 mld snooping robustness-variable

3.11.2.11 (config-if-vlan)# ipv6 mld snooping unsolicited-report-interval <ipmc_uri>

Syntax: (config-if-vlan)# ipv6 mld snooping unsolicited-report-interval <ipmc_uri>

Explanation: The Unsolicited Report Interval is the amount of time that the upstream interface should transmit unsolicited IGMP reports when report suppression/proxy reporting is enabled. The allowed range for URI is 0 -31744 seconds.

Parameters:

<ipmc_uri: 0-31744>: Specify Unsolicited Report Interval value. The valid value is 0~31744.

Negation: (config-if-vlan)# no ipv6 mld snooping unsolicited-report-interval

CHAPTER 4. WEB OPERATION & CONFIGURATION

4.1 Introduction

Web-based management provides easy-to-use and straightforward graphic interface for users to configure the device quickly. The web-based management of this device supports various web browsers such as Internet Explorer (Version 9.0 or above is recommended), Firefox or Google Chrome. To access the web management interface for the first time or after returning the device back to factory defaults, enter the default IP address of the IGS in the browser's location bar. See below for explanations.

4.1.1 Login

To enter the web based management for the first time or after returning the device back to factory defaults, input the default IP address “10.1.1.1” in your web browser. Then, a standard login prompt will appear depending on the type of browser used. The example below is with Firefox browser.

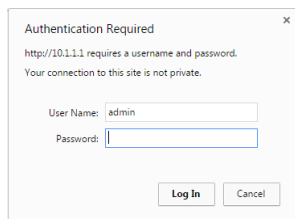

Enter the factory default username “admin” with “no password”. After successfully entering the web based management, the Port State page will appear.



Web Home Page

4.1.2 Port Status

The initial page, when logged in, displays a graphical overview of the port status for the electrical and optical ports. The "Green" colored port indicates a LAN connection with a speed of 100M. The "Amber" colored port indicates a connection speed of 1000M.

The status display can be reached by using the left side menu, and return to **Ports>State**.

4.1.3 Refresh

To update the screen, click the "Refresh" button. For automatic updating of the screen, the "Auto-refresh" tick box may be ticked. The screen will be auto refreshed every 3 seconds.

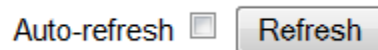

Unless connected directly on a local LAN, we recommend not using the auto-refresh function as it does generate a bit of traffic.

4.1.4 Help System

The device has an online "help" system to aid the engineer when setting the parameters of the device. Each functional setting page is accompanied by a specific "help" for that functional page. The user can display this help "pop up" at any time by clicking the "help" icon.



4.1.5 Logout

After completing configuration, we recommend logging out of the web GUI. This is easily accomplished by clicking the logout icon.



After clicking the logout icon, a confirmation screen will be displayed. Click "OK" to finish logging out or click "Cancel" to return to the web configuration GUI.

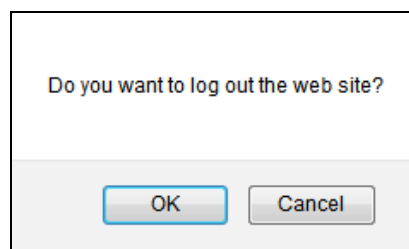

For the remainder of this section, each menu item will be explained one by one, in order as they descend down the menu screen, starting with the "System" menu.

4.2 System

The configuration under the "System" menu includes device settings such as IP address, time server, etc.

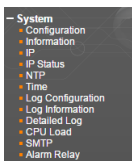

4.2.1 System Configuration

The configuration information entered here will be reported in the standard SNMP MIB2 for 'sysContact' (OID 1.3.6.1.2.1.1.4), 'sysName' (OID 1.3.6.1.2.1.1.5) and 'sysLocation' (OID 1.3.6.1.2.1.1.6). Remember to click the "Save" button after entering the configuration information.

System Contact: Indicate the descriptive contact information. This could be a person's name, email address or other descriptions. The allowed string length is 0~255 and the allowed content is the ASCII characters from 32~126.

System Name: Indicate the hostname for this device. Alphabets (A-Z; a-z), digits (0-9) and minus sign (-) can be used. However, space characters are not allowed. The first character must be an alphabet character. The first and last character must not be a minus sign. The allowed string length is 0~255.

System Location: Indicate the location of this device. The allowed string length is 0~255.

4.2.2 System Information

The system information screen will display the configuration information, the hardware MAC address and version, the system time, the system "uptime" and the software version and build date.

System Information	
System	
Contact Name	
Location	
Hardware	
MAC Address	00-02-ab-80-8a-1a
Hardware Version	V1.2
Series Number	Undefined
Time	
System Date	1970-01-01T00:38:33+00:00
System Uptime	0d 00:38:33
Software	
Software Version	Ver 1.01
Software Date	2022-09-15T08:57:19+08:00

4.2.3 System IP

Setup the IP configuration, interface and routes.

IP Configuration

Domain Name	No Domain Name
Mode	Host
DNS Server 0	No DNS server
DNS Server 1	No DNS server
DNS Server 2	No DNS server
DNS Server 3	No DNS server
DNS Proxy	<input type="checkbox"/>

IP Interfaces

Delete	VLAN	Enable	DHCPv4				IPv4				DHC					
			Type	IfMac	ASCII	HEX	Hostname	Fallback	Current Lease	Renewal		Restart	Address	Mask Length	Enable	Rai Com
<input type="checkbox"/>	1	<input type="checkbox"/>	Auto	Port 1					0		Renewal	Restart	10.1.1.1	8	<input type="checkbox"/>	

IP Routes

Delete	Network	Mask Length	Gateway	Distance(IPv4) / Next Hop VLAN(IPv6)
<input type="button" value="Add Route"/>				

IP Configuration

Domain Name: This setting controls the DNS name resolution done by the switch. The following modes are supported:

No Domain Name: No DNS server will be used.

Configured Domain Name: Explicitly provide the IP address of the DNS Server in dotted decimal notation.

From any DHCP interfaces: The first DNS server offered from a DHCP lease to a DHCP-enabled interface will be used.

From this DHCP interface: Specify from which DHCP-enabled interface a provided DNS server should be preferred.

Mode: This pull-down menu configures whether the IP stack should act as a Host or a Router. In Host mode, IP traffic between interfaces will not be routed. In Router mode traffic is routed between all interfaces. When configuring this device for multiple VLANs, the Router mode should be chosen. Router mode is the default mode.

DNS Server: This setting controls the DNS name resolution done by the switch. There are four servers available for configuration, and the index of the server presents the preference (less index has higher priority) in doing DNS name resolution. The following modes are supported:

No DNS server: No DNS server will be used.

Configured IPv4: Explicitly provide the valid IPv4 unicast address of the DNS Server in dotted decimal notation. Make sure the configured DNS server could be reachable (e.g. via PING) for activating DNS service.

Configured IPv6: Explicitly provide the valid IPv6 unicast (except linklocal) address of the DNS Server. Make sure the configured DNS server could be reachable (e.g. via PING6) for activating DNS service.

From any DHCPv4 interfaces: The first DNS server offered from a DHCPv4 lease to a DHCPv4-enabled interface will be used.

From this DHCPv4 interface: Specify from which DHCPv4-enabled interface a provided DNS server should be preferred.

From any DHCPv6 interfaces: The first DNS server offered from a DHCPv6 lease to a DHCPv6-enabled interface will be used.

From this DHCPv6 interface: Specify from which DHCPv6-enabled interface a provided DNS server should be preferred.

DNS Proxy: When DNS proxy is enabled, the system will relay DNS requests to the currently configured DNS server, and reply as a DNS resolver to the client devices on the network.

IP Interface

Click Add Interface button to add a new IP interface. A maximum of 128 interfaces is supported.

VLAN: This is the VLAN associated with the IP interface. Only ports in this VLAN will be able to access the IP interface. This field is only available for input when creating a new interface.

DHCPv4 Enable: When this checkbox is enabled, the system will configure the IPv4 address and mask of the interface using the DHCP protocol. The DHCP client will announce the configured System Name as hostname to provide DNS lookup.

DHCPv4 Clinet Identifier Type: The type of IPv4 DHCP Clinet ID. When Auto is selected, the field uses the configured system name. If the system name is also empty, the field uses the product name and the latest three bytes of system MAC addresses as the hostname.

DHCPv4 Clinet Identifier IfMac: The interface name of DHCP client identifier. When DHCPv4 client is enabled and the client identifier type is 'ifmac', the configured interface's hardware MAC address will be used in the DHCP option 61 field.

DHCPv4 Clinet Identifier ASCII: The ASCII string of DHCP client identifier. When DHCPv4 client is enabled and the client identifier type is 'ascii', the ASCII string will be used in the DHCP option 61 field.

NOTE: System will convert the ID to lower case and replace spaces by dashes.

DHCPv4 Clinet Identifier HEX: The hexadecimal string of DHCP client identifier. When DHCPv4 client is enabled and the client identifier type 'hex', the hexadecimal value will be used in the DHCP option 61 field.

DHCPv4 Hostname: The hostname of DHCP client. If DHCPv4 client is enabled, the configured hostname will be used in the DHCP option 12 field. When this value is empty string, the field uses the configured system name. If the system name is also empty, the field uses the product name plus the latest three bytes of system MAC addresses as the hostname.

NOTE: System will convert the name to lower case and replace spaces by dashes.

DHCPv4 Fallback: The number of seconds for trying to obtain a DHCP lease. After this period expires, a configured IPv4 address will be used as IPv4 interface address. A value of zero disables fallback mechanism. The DHCP will keep retrying until a valid lease is obtained when fallback is disabled. The transmission delay is a randomization value that up to a maximum of 64 seconds. Legal values are 0 or 65 to 4294967295 seconds.

IPv4 Current Lease: For DHCP interfaces with an active lease, this column shows the current interface address, as provided by the DHCP server.

IPv4 Address: The IPv4 address of the interface is entered in dotted decimal notation. If DHCP is enabled, this field is not used. The field may also be left blank if IPv4 operation on the interface is not desired.

IPv4 Mask Length: The IPv4 network mask is entered by a number of bits (prefix length). Valid values are between 0 and 30 bits for a IPv4 address. If DHCP is enabled, this field is not used. The field may also be left blank if IPv4 operation on the interface is not desired.

DHCPv6 Enable: When this checkbox is enabled, the system will configure the IPv6 address and mask of the interface using the DHCP protocol.

Rapid Commit: If this option is enabled, the DHCPv6 client terminates the waiting process as soon as a Reply message with a Rapid Commit option is received. This option is only manageable when DHCPv6 client is enabled.

IPv6 Current Lease: For DHCP interfaces with an active lease, this column shows the current interface address, as provided by the DHCP server.

IPv6 Address: A IPv6 address is a 128-bit record represented as eight fields of up to four hexadecimal digits with a colon separating each field (:). For example, fe80::215:c5ff:fe03:4dc7. The symbol :: is a special syntax that can be used as a shorthand way of representing multiple 16-bit groups of contiguous zeros; but it can appear only once. It can also represent a legally valid IPv4 address. For example, ::192.1.2.34. The field may be left blank if IPv6 operation on the interface is not desired.

IPv6 Mask Length: The IPv6 network mask is entered by a number of bits (prefix length). Valid values are between 1 and 128 bits for an IPv6 address. The field may be left blank if IPv6 operation on the interface is not desired.

IP Routes

Route Network: The IP route is the destination IP network or host address of this route. Valid format is dotted decimal notation or a valid IPv6 notation. A default route can use the value 0.0.0.0 or for IPv6 use the :: notation.

Route Mask: The route mask is a destination IP network or host mask, in number of bits (prefix length). It defines how much of a network address that must match, in order to qualify for this route. Valid values are between 0 and 32 bits respectively 128 for IPv6 routes. Only a default route will have a mask length of 0 (as it will match anything).

Gateway: This is the IP address of the gateway. Valid format is dotted decimal notation or a valid IPv6 notation. Gateway and Network must be of the same type.

Next Hop VLAN (Only for IPv6): The VLAN ID of the specific IPv6 interface associated with the gateway. The given VID ranging from 1 to 4095 will be effective only when the corresponding IPv6 interface is valid. If the IPv6 gateway

address is link-local, it must specify the next hop VLAN for the gateway. If the IPv6 gateway address is not link-local, the device will ignore the next hop VLAN for the gateway.

Distance (Only for IPv4): The distance value of route entry is used to provide the priority information of the routing protocols to routers. When there are two or more different routing protocols are involved and have the same destination, the distance value can be used to select the best path.

4.2.4 System IP Status

Display the status of IP interfaces and routes.

IP Interfaces Auto-refresh Refresh

Interface	Type	Address	Status
VLAN 1	LINK	00-02-ab-35-02-b7	<UP BROADCAST MULTICAST>
VLAN 1	IPv4	10.1.1.1/24	
VLAN 1	IPv6	fe80::202:abff:fe35:2b7/64	
VLAN 10	LINK	00-02-ab-35-02-b7	<BROADCAST MULTICAST>
VLAN 10	IPv4	172.16.1.90/24	

IP Routes

IPv4

Network	Gateway	Status
10.1.1.0/24	VLAN 1	<UP>

IPv6

Network	Gateway	Status
fe80::/64	VLAN 1	<UP>

Neighbor cache

IPv4

IP Address	Link Address
10.1.1.169	VLAN 1:00-e0-4c-36-15-4b

IPv6

IP Address	Link Address
------------	--------------

Please refer to “System IP” for the configuration of the interfaces and routes. This page is informational only.

4.2.5 System NTP

Setup the Network Time Protocol configuration, to synchronize the device’s clock to network time.

NTP Configuration

Mode	Enabled
Server 1	59.124.196.83
Server 2	168.95.1.12
Server 3	210.68.16.24
Server 4	
Server 5	

Save Reset

Mode: Configure the NTP mode operation. Possible modes are:

Enabled: Enable NTP client mode operation.

Disabled: Disable NTP client mode operation.

Server #: Enter the IPv4 or IPv6 address of an NTP server. IPv6 address is in 128-bit records represented as eight fields of up to four hexadecimal digits with a colon separating each field (:). For example, 'fe80::215:c5ff:fe03:4dc7'. The symbol '::' is a special syntax that can be used as a shorthand way of representing multiple 16-bit groups of contiguous zeros; but it can appear only once. NTP servers can also be represented by a legally valid IPv4 address. For example, '::192.1.2.34'. The NTP servers are tried in numeric order. If 'Server 1' is unavailable, the NTP client will try to contact 'Server 2'.

4.2.6 System Time

Setup the device time.

Time Zone Configuration

Time Zone Configuration	
Time Zone	(UTC) Coordinated Universal Time
Hours	0
Minutes	0
Acronym	<input type="text" value=""/> (0 - 16 characters)

Daylight Saving Time Configuration

Daylight Saving Time Mode

Daylight Saving Time	Recurring
----------------------	-----------

Start Time settings	
Week	2
Day	Sun
Month	Mar
Hours	2
Minutes	0
End Time settings	
Week	1
Day	Sun
Month	Nov
Hours	2
Minutes	0
Offset settings	
Offset	60 (1 - 1440) Minutes

The setting example above is for Eastern Standard Time in the United States. Daylight savings time starts on the second Sunday in March at 2:00AM. Daylight savings ends on the first Sunday in November at 2:00AM. The daylight savings time offset is 60 minutes (1 hour).

Time Zone Configuration

Time Zone: Lists various Time Zones worldwide. Select appropriate Time Zone from the drop down and click Save to set.

Acronym: Set the acronym of the time zone.

Daylight Saving Time Configuration

Daylight Saving Time: This is used to set the clock forward or backward according to the configurations set below for a defined Daylight Saving Time duration. Select "Disable" to disable the Daylight Saving Time configuration. Select "Recurring" and configure the Daylight Saving Time duration to repeat the configuration every year. Select "Non-Recurring" and configure the Daylight Saving Time duration for single time configuration. (Default is Disabled)

Recurring & Non-Recurring Configurations:

Start time settings: Select the starting week, day, month, year, hours, and minutes.

End time settings: Select the ending week, day, month, year, hours, and minutes.

Offset settings: Enter the number of minutes to add during Daylight Saving Time. The allowed range is 1 to 1440.

4.2.7 System Log Configuration

Configure System Log on this page.

The screenshot shows a web configuration interface titled "System Log Configuration". It contains three dropdown menus: "Server Mode" set to "Disabled", "Server Address" (empty), and "Syslog Level" set to "Informational". Below the dropdowns are two buttons: "Save" and "Reset".

Server Mode: This sets the server mode operation. When the mode of operation is enabled, the syslog message will send out to syslog server (at the server address). The syslog protocol is based on UDP communication and received on UDP port 514. Syslog server will not send acknowledgments back to the sender since UDP is a connectionless protocol and it does not provide acknowledgments. The syslog packet will always send out, even if the syslog server does not exist. When the mode of operation is disabled, no syslog packets are sent out.

Server Address: This sets the IPv4 host address of syslog server. If the switch provides DNS feature, it also can be a host name.

Syslog Level: This sets what kind of messages will send to system log server. Possible levels are:

Error: Send the specific message when the severity code is less or equal than Error (3).

Warning: Send the specific message when the severity code is less or equal than Warning (4).

Notice: Send the specific message when the severity code is less or equal than Notice (5).

Informational: Send the specific message when the severity code is less or equal than Informational (6).

4.2.8 System Log Information

Displays the collected log information.

System Log Information Auto-refresh Refresh Clear |<< << >> >>|

Level: Clear Level:

The total number of entries is 22 for the given level.

Start from ID with entries per page.

ID	Level	Time	Message
1	Informational	1970-01-01T00:00:16+00:00	SYS-BOOTING: Switch just made a cold boot.
2	Notice	1970-01-01T00:00:16+00:00	LINK-UPDOWN: IP Interface VLAN 1 changed state to down.
3	Notice	1970-01-01T00:00:16+00:00	LINK-UPDOWN: IP Interface VLAN 1 changed state to down.
4	Notice	1970-01-01T00:00:16+00:00	LINK-UPDOWN: IP Interface VLAN 10 changed state to down.
5	Notice	1970-01-01T00:02:22+00:00	LINK-UPDOWN: Interface GigabitEthernet 1/11, changed state to up.
6	Notice	1970-01-01T00:02:29+00:00	LINK-UPDOWN: IP Interface VLAN 1 changed state to up.
7	Notice	1970-01-01T00:02:49+00:00	LINK-UPDOWN: Interface GigabitEthernet 1/11, changed state to down.
8	Notice	1970-01-01T00:02:50+00:00	LINK-UPDOWN: IP Interface VLAN 1 changed state to down.
9	Notice	1970-01-01T00:02:59+00:00	LINK-UPDOWN: Interface GigabitEthernet 1/11, changed state to up.
10	Notice	1970-01-01T00:03:05+00:00	LINK-UPDOWN: IP Interface VLAN 1 changed state to up.
11	Notice	1970-01-01T00:03:10+00:00	LINK-UPDOWN: Interface GigabitEthernet 1/11, changed state to down.
12	Notice	1970-01-01T00:03:11+00:00	LINK-UPDOWN: IP Interface VLAN 1 changed state to down.
13	Notice	1970-01-01T00:03:14+00:00	LINK-UPDOWN: Interface GigabitEthernet 1/11, changed state to up.
14	Notice	1970-01-01T00:03:20+00:00	LINK-UPDOWN: IP Interface VLAN 1 changed state to up.
15	Notice	1970-01-01T00:03:21+00:00	LINK-UPDOWN: Interface GigabitEthernet 1/11, changed state to down.
16	Notice	1970-01-01T00:03:23+00:00	LINK-UPDOWN: IP Interface VLAN 1 changed state to down.
17	Notice	1970-01-01T00:03:28+00:00	LINK-UPDOWN: Interface GigabitEthernet 1/8, changed state to up.
18	Notice	1970-01-01T00:03:35+00:00	LINK-UPDOWN: IP Interface VLAN 1 changed state to up.
19	Notice	1970-01-01T00:03:55+00:00	LINK-UPDOWN: Interface GigabitEthernet 1/8, changed state to down.
20	Notice	1970-01-01T00:03:56+00:00	LINK-UPDOWN: IP Interface VLAN 1 changed state to down.

Level: Use this pull down to display all messages or messages of type info, warning or error.

Clear Level: Use this pull down to clear selected message types from the log.

Browsing buttons: Use these buttons to quickly go to the beginning or end of the log or to page through the log.

4.2.9 System Detailed Log

Displays individual log records.

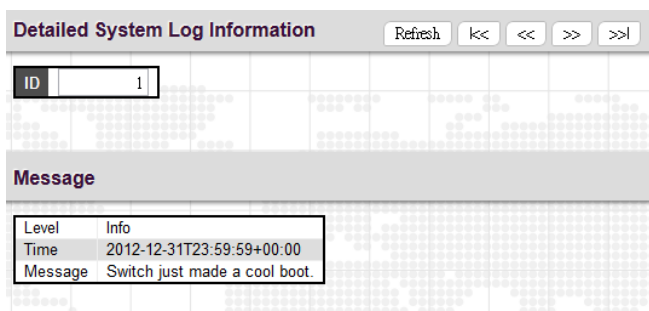

View each log, by ID number.

4.2.10 System CPU Load

This page displays the CPU load, using an SVG graph.

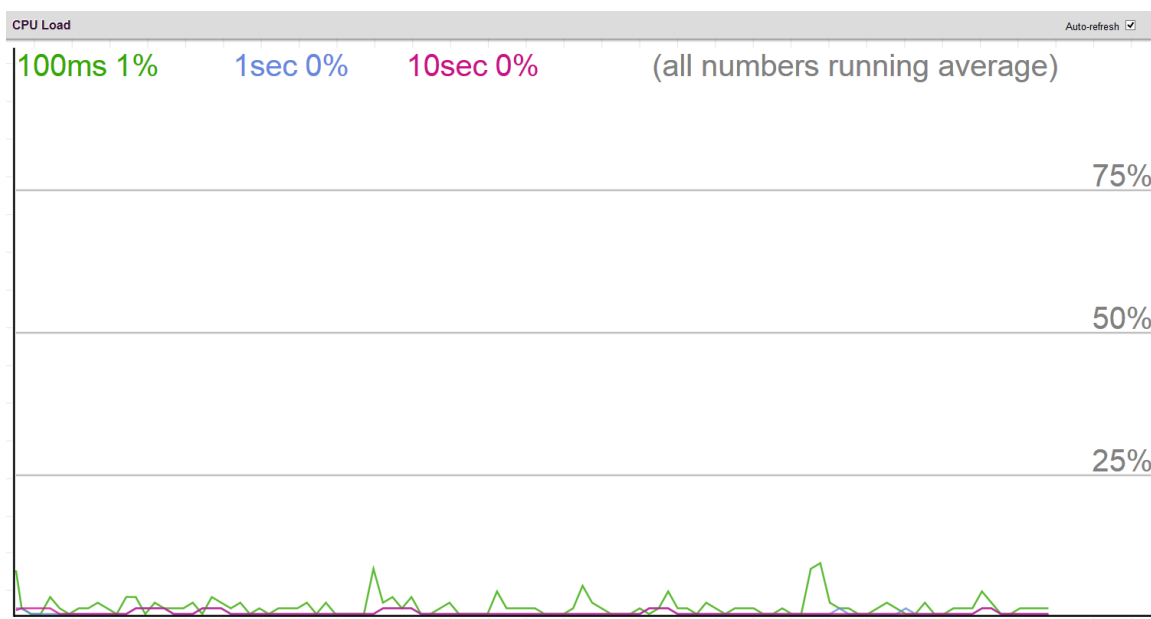

The load is measured as averaged over the last 100ms, 1sec and 10 seconds intervals. The last 120 samples are graphed, and the last numbers are displayed as text as well. In order to display the SVG graph, your browser must support the SVG format. Automatic refresh occurs every 3 seconds.

4.2.11 Alarm Relay

Alarm Relay Configuration

Alarm Relay Mode: Disabled

Alarm Relay Event

System	<input checked="" type="radio"/> none	<input type="radio"/> DI(Low)	<input type="radio"/> DI(High)
Power	<input type="checkbox"/> * Power1 Status		
	<input type="checkbox"/> Power2 Status		
Interface	<input type="checkbox"/> * Link down	<input checked="" type="radio"/> none	<input type="radio"/> specific
	<input type="checkbox"/> PoE	<input checked="" type="radio"/> none	<input type="radio"/> specific
		<input type="radio"/> all ports	<input type="radio"/> all ports

Save Reset

Alarm Relay Mode: Enable or disable alarm relay function.

Alarm Relay Event

System: Indicates System alarm relay. Possible options are:

DI (Low): Select the checkbox to enable DI (Low) alarm relay function.

DI (High): Select the checkbox to enable DI (High) alarm relay function.

Power: Indicates the Power group's alarm relay. Possible options are:

Power 1 Status: Select the checkbox to enable Power 1 status alarm relay function. Once power 1 fails, the alarm relay contacts are open and Fault LED indicator is on in amber. Clear the checkbox to disable Power 1 status alarm relay.

Power 2 Status: Select the checkbox to enable Power 2 status alarm relay function. Once power 2 fails, the alarm relay contacts are open and Fault LED indicator is on in amber. Clear the checkbox to disable Power 2 status alarm relay.

Interface: Indicates the Interface group's alarm relay. Possible options are:

Link Down: none/specific/all ports Link down alarm relay. Once link down occurs on the selected interfaces, the alarm relay contacts are open, Fault LED indicator is on in amber. Clear the checkbox to disable alarm relay function.

When the "specific" radio button is selected, a popup graphic with port checkboxes allows selection specific ports.

NOTE: For more information about alarm relay circuit on the terminal block, please see [Alarm Relay](#) section.

4.3 Green Ethernet

The configuration pages under the “Green Ethernet” menu include a number of power saving techniques.

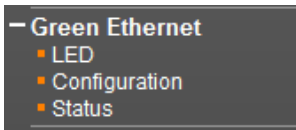

4.3.1 Green Ethernet LED

Configure the LED light intensity to reduce power consumption.

LED Power Reduction Configuration

LED Intensity Timers

Delete	Start Time	End Time	Intensity
<input type="checkbox"/>	08:00	18:00	50 %
<input type="checkbox"/>	18:00	08:00	10 %

Add Time

Maintenance

On time at link change	On at errors
10 Sec.	<input checked="" type="checkbox"/>

Save Reset

The LED light intensity may be adjusted in a percentage of intensity during programmable time periods. In the above setting example, the LED intensity has been adjusted to 50% during daylight hours and reduced to only 10% intensity during night hours.

The maintenance checkbox will bring LED intensity to 100% for 10 seconds in the event of any error (such as link down).

4.3.2 Green Ethernet Configuration

Configure EEE (Energy-Efficient Ethernet) as well as Ethernet power savings on copper ports.

Port	ActiPHY	PerfectReach	EEE	EEE Urgent Queues									
				1	2	3	4	5	6	7	8		
*	<input type="checkbox"/>	<input type="checkbox"/>	<input type="checkbox"/>	<input type="checkbox"/>	<input type="checkbox"/>	<input type="checkbox"/>	<input type="checkbox"/>	<input type="checkbox"/>	<input type="checkbox"/>	<input type="checkbox"/>	<input type="checkbox"/>	<input type="checkbox"/>	<input type="checkbox"/>
1	<input type="checkbox"/>	<input type="checkbox"/>	<input type="checkbox"/>	<input type="checkbox"/>	<input type="checkbox"/>	<input type="checkbox"/>	<input type="checkbox"/>	<input type="checkbox"/>	<input type="checkbox"/>	<input type="checkbox"/>	<input type="checkbox"/>	<input type="checkbox"/>	<input type="checkbox"/>
2	<input type="checkbox"/>	<input type="checkbox"/>	<input type="checkbox"/>	<input type="checkbox"/>	<input type="checkbox"/>	<input type="checkbox"/>	<input type="checkbox"/>	<input type="checkbox"/>	<input type="checkbox"/>	<input type="checkbox"/>	<input type="checkbox"/>	<input type="checkbox"/>	<input type="checkbox"/>
3	<input type="checkbox"/>	<input type="checkbox"/>	<input type="checkbox"/>	<input type="checkbox"/>	<input type="checkbox"/>	<input type="checkbox"/>	<input type="checkbox"/>	<input type="checkbox"/>	<input type="checkbox"/>	<input type="checkbox"/>	<input type="checkbox"/>	<input type="checkbox"/>	<input type="checkbox"/>
4	<input type="checkbox"/>	<input type="checkbox"/>	<input type="checkbox"/>	<input type="checkbox"/>	<input type="checkbox"/>	<input type="checkbox"/>	<input type="checkbox"/>	<input type="checkbox"/>	<input type="checkbox"/>	<input type="checkbox"/>	<input type="checkbox"/>	<input type="checkbox"/>	<input type="checkbox"/>
5	<input type="checkbox"/>	<input type="checkbox"/>	<input type="checkbox"/>	<input type="checkbox"/>	<input type="checkbox"/>	<input type="checkbox"/>	<input type="checkbox"/>	<input type="checkbox"/>	<input type="checkbox"/>	<input type="checkbox"/>	<input type="checkbox"/>	<input type="checkbox"/>	<input type="checkbox"/>
6	<input type="checkbox"/>	<input type="checkbox"/>	<input type="checkbox"/>	<input type="checkbox"/>	<input type="checkbox"/>	<input type="checkbox"/>	<input type="checkbox"/>	<input type="checkbox"/>	<input type="checkbox"/>	<input type="checkbox"/>	<input type="checkbox"/>	<input type="checkbox"/>	<input type="checkbox"/>
7	<input type="checkbox"/>	<input type="checkbox"/>	<input type="checkbox"/>	<input type="checkbox"/>	<input type="checkbox"/>	<input type="checkbox"/>	<input type="checkbox"/>	<input type="checkbox"/>	<input type="checkbox"/>	<input type="checkbox"/>	<input type="checkbox"/>	<input type="checkbox"/>	<input type="checkbox"/>
8	<input type="checkbox"/>	<input type="checkbox"/>	<input type="checkbox"/>	<input type="checkbox"/>	<input type="checkbox"/>	<input type="checkbox"/>	<input type="checkbox"/>	<input type="checkbox"/>	<input type="checkbox"/>	<input type="checkbox"/>	<input type="checkbox"/>	<input type="checkbox"/>	<input type="checkbox"/>
9	<input type="checkbox"/>	<input type="checkbox"/>	<input type="checkbox"/>	<input type="checkbox"/>	<input type="checkbox"/>	<input type="checkbox"/>	<input type="checkbox"/>	<input type="checkbox"/>	<input type="checkbox"/>	<input type="checkbox"/>	<input type="checkbox"/>	<input type="checkbox"/>	<input type="checkbox"/>
10	<input type="checkbox"/>	<input type="checkbox"/>	<input type="checkbox"/>	<input type="checkbox"/>	<input type="checkbox"/>	<input type="checkbox"/>	<input type="checkbox"/>	<input type="checkbox"/>	<input type="checkbox"/>	<input type="checkbox"/>	<input type="checkbox"/>	<input type="checkbox"/>	<input type="checkbox"/>
11	<input type="checkbox"/>	<input type="checkbox"/>	<input type="checkbox"/>	<input type="checkbox"/>	<input type="checkbox"/>	<input type="checkbox"/>	<input type="checkbox"/>	<input type="checkbox"/>	<input type="checkbox"/>	<input type="checkbox"/>	<input type="checkbox"/>	<input type="checkbox"/>	<input type="checkbox"/>
12	<input type="checkbox"/>	<input type="checkbox"/>	<input type="checkbox"/>	<input type="checkbox"/>	<input type="checkbox"/>	<input type="checkbox"/>	<input type="checkbox"/>	<input type="checkbox"/>	<input type="checkbox"/>	<input type="checkbox"/>	<input type="checkbox"/>	<input type="checkbox"/>	<input type="checkbox"/>
13	<input type="checkbox"/>	<input type="checkbox"/>	<input type="checkbox"/>	<input type="checkbox"/>	<input type="checkbox"/>	<input type="checkbox"/>	<input type="checkbox"/>	<input type="checkbox"/>	<input type="checkbox"/>	<input type="checkbox"/>	<input type="checkbox"/>	<input type="checkbox"/>	<input type="checkbox"/>
14	<input type="checkbox"/>	<input type="checkbox"/>	<input type="checkbox"/>	<input type="checkbox"/>	<input type="checkbox"/>	<input type="checkbox"/>	<input type="checkbox"/>	<input type="checkbox"/>	<input type="checkbox"/>	<input type="checkbox"/>	<input type="checkbox"/>	<input type="checkbox"/>	<input type="checkbox"/>
15	<input type="checkbox"/>	<input type="checkbox"/>	<input type="checkbox"/>	<input type="checkbox"/>	<input type="checkbox"/>	<input type="checkbox"/>	<input type="checkbox"/>	<input type="checkbox"/>	<input type="checkbox"/>	<input type="checkbox"/>	<input type="checkbox"/>	<input type="checkbox"/>	<input type="checkbox"/>
16	<input type="checkbox"/>	<input type="checkbox"/>	<input type="checkbox"/>	<input type="checkbox"/>	<input type="checkbox"/>	<input type="checkbox"/>	<input type="checkbox"/>	<input type="checkbox"/>	<input type="checkbox"/>	<input type="checkbox"/>	<input type="checkbox"/>	<input type="checkbox"/>	<input type="checkbox"/>
17	<input type="checkbox"/>	<input type="checkbox"/>	<input type="checkbox"/>	<input type="checkbox"/>	<input type="checkbox"/>	<input type="checkbox"/>	<input type="checkbox"/>	<input type="checkbox"/>	<input type="checkbox"/>	<input type="checkbox"/>	<input type="checkbox"/>	<input type="checkbox"/>	<input type="checkbox"/>
18	<input type="checkbox"/>	<input type="checkbox"/>	<input type="checkbox"/>	<input type="checkbox"/>	<input type="checkbox"/>	<input type="checkbox"/>	<input type="checkbox"/>	<input type="checkbox"/>	<input type="checkbox"/>	<input type="checkbox"/>	<input type="checkbox"/>	<input type="checkbox"/>	<input type="checkbox"/>
19	<input type="checkbox"/>	<input type="checkbox"/>	<input type="checkbox"/>	<input type="checkbox"/>	<input type="checkbox"/>	<input type="checkbox"/>	<input type="checkbox"/>	<input type="checkbox"/>	<input type="checkbox"/>	<input type="checkbox"/>	<input type="checkbox"/>	<input type="checkbox"/>	<input type="checkbox"/>
20	<input type="checkbox"/>	<input type="checkbox"/>	<input type="checkbox"/>	<input type="checkbox"/>	<input type="checkbox"/>	<input type="checkbox"/>	<input type="checkbox"/>	<input type="checkbox"/>	<input type="checkbox"/>	<input type="checkbox"/>	<input type="checkbox"/>	<input type="checkbox"/>	<input type="checkbox"/>

Port Power Savings Configuration

Optimize EEE for: Enables/disables the EEE function for this switch. The two options are:

Power: The EEE function is enabled. This is the default setting.

Legacy: EEE is not enabled.

Port Configuration

ActiPHY™: ActiPHY™ works by lowering the power for a port when there is no link. The port is power up for short moment in order to determine if an Ethernet cable is inserted. For ports with no cable connection, the PHY remains powered down to save energy.

PerfectReach™: PerfectReach™ is another power saving mechanism. PerfectReach™ works by determining the cable length and lowering the Ethernet transmit power for ports with short cables.

EEE (Energy-Efficient Ethernet): EEE is a power saving option that reduces the power usage when there is low or no traffic utilization. EEE was developed through the IEEE802.3az task force of the Institute of Electrical and Electronic Engineers (IEEE). EEE works by powering down circuits when there is no traffic. When a port gets data to be transmitted all circuits are powered up. The time it takes to power up the circuits is called wakeup time. The default wakeup time is 17 us for 1Gbit links and 30 us for other link speeds. EEE devices must agree upon the value of the wakeup time in order to make sure that both the receiving and transmitting device has all circuits powered up when traffic is transmitted. The devices can exchange wakeup time information using the LLDP (Link Layer Discovery Protocol) protocol. EEE works for ports in auto-negotiation mode, where the port is negotiated to either 1G or 100

Mbit full duplex mode. For ports that are not EEE-capable the corresponding EEE checkboxes are grayed out and thus impossible to enable EEE for.

When a port is powered down for saving power, outgoing traffic is stored in a buffer until the port is powered up again. Because there are some overhead in turning the port down and up, more power can be saved if the traffic can be buffered up until a large burst of traffic can be transmitted. Buffering traffic will give some latency in the traffic. For traffic that should not be held back, urgent queues may be assigned to reduce latency yet still result in overall power saving.

EEE Urgent Queues: It is possible to minimize the latency for specific frames, by mapping the frames to a specific queue (done with QoS), and then mark the queue as an urgent queue. When an urgent queue gets data to be transmitted, the circuits will be powered up at once and the latency will be reduced to the wakeup time.

Queues set will activate transmission of frames as soon as data is available. Otherwise the queue will postpone transmission until a burst of frames can be transmitted.

4.3.3 Green Ethernet Status

Display the energy saving status for all ports.

Port Power Savings Status								Auto-refresh <input type="checkbox"/>	Refresh
Port	Link	EEE Cap	EEE Ena	LP EEE Cap	EEE In power save	ActiPhy Savings	PerfectReach Savings		
1	●	✓	✗	✗	✗	✗	✗	✗	
2	●	✓	✗	✗	✗	✗	✗	✗	
3	●	✓	✗	✗	✗	✗	✗	✗	
4	●	✓	✗	✗	✗	✗	✗	✗	
5	●	✓	✗	✗	✗	✗	✗	✗	
6	●	✓	✗	✗	✗	✗	✗	✗	
7	●	✓	✗	✗	✗	✗	✗	✗	
8	●	✓	✗	✓	✗	✗	✗	✗	
9	●	✓	✗	✗	✗	✗	✗	✗	
10	●	✓	✗	✗	✗	✗	✗	✗	
11	●	✓	✗	✗	✗	✗	✗	✗	
12	●	✓	✗	✗	✗	✗	✗	✗	
13	●	✓	✗	✗	✗	✗	✗	✗	
14	●	✓	✗	✗	✗	✗	✗	✗	
15	●	✓	✗	✗	✗	✗	✗	✗	
16	●	✓	✗	✗	✗	✗	✗	✗	
17	●	✗	✗	✗	✗	✗	✗	✗	
18	●	✗	✗	✗	✗	✗	✗	✗	
19	●	✗	✗	✗	✗	✗	✗	✗	
20	●	✗	✗	✗	✗	✗	✗	✗	

4.4 Ports

Configurations related to the fiber and electrical ports are performed under the Ports menu.

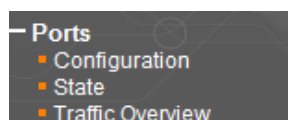

4.4.1 Ports Configuration

This page displays current port configurations and allows some configuration here.

Port Configuration																				Display the progress of ongoing downloads (Ctrl+J)		
Port	Link	Warning	Current	Speed	Adv Duplex		Adv speed				Flow Control			PFC		Maximum Frame Size	Excessive Collision Mode	Frame Length Check	FEC Mode			
				Configured	Fdx	Hdx	10M	100M	1G	2.5G	5G	10G	Enable	Curr Rx	Curr Tx					Enable	Priority	
-				<->	<input checked="" type="checkbox"/>	<input checked="" type="checkbox"/>	<input checked="" type="checkbox"/>	<input checked="" type="checkbox"/>	<input checked="" type="checkbox"/>	<input checked="" type="checkbox"/>	<input type="checkbox"/>	<input type="checkbox"/>	<input type="checkbox"/>	<input type="checkbox"/>	<input type="checkbox"/>	0-7	10240	<->	<input type="checkbox"/>	<->		
1	●	●	Down	Automatic	<input checked="" type="checkbox"/>	<input checked="" type="checkbox"/>	<input checked="" type="checkbox"/>	<input checked="" type="checkbox"/>	<input checked="" type="checkbox"/>	<input checked="" type="checkbox"/>	<input type="checkbox"/>	<input type="checkbox"/>	<input type="checkbox"/>	<input type="checkbox"/>	<input checked="" type="checkbox"/>	<input checked="" type="checkbox"/>	<input type="checkbox"/>	0-7	10240	Discard	<input type="checkbox"/>	
2	●	●	Down	Automatic	<input checked="" type="checkbox"/>	<input checked="" type="checkbox"/>	<input checked="" type="checkbox"/>	<input checked="" type="checkbox"/>	<input checked="" type="checkbox"/>	<input checked="" type="checkbox"/>	<input type="checkbox"/>	<input type="checkbox"/>	<input type="checkbox"/>	<input type="checkbox"/>	<input checked="" type="checkbox"/>	<input checked="" type="checkbox"/>	<input type="checkbox"/>	0-7	10240	Discard	<input type="checkbox"/>	
3	●	●	Down	Automatic	<input checked="" type="checkbox"/>	<input checked="" type="checkbox"/>	<input checked="" type="checkbox"/>	<input checked="" type="checkbox"/>	<input checked="" type="checkbox"/>	<input checked="" type="checkbox"/>	<input type="checkbox"/>	<input type="checkbox"/>	<input type="checkbox"/>	<input type="checkbox"/>	<input checked="" type="checkbox"/>	<input checked="" type="checkbox"/>	<input type="checkbox"/>	0-7	10240	Discard	<input type="checkbox"/>	
4	●	●	Down	Automatic	<input checked="" type="checkbox"/>	<input checked="" type="checkbox"/>	<input checked="" type="checkbox"/>	<input checked="" type="checkbox"/>	<input checked="" type="checkbox"/>	<input checked="" type="checkbox"/>	<input type="checkbox"/>	<input type="checkbox"/>	<input type="checkbox"/>	<input type="checkbox"/>	<input checked="" type="checkbox"/>	<input checked="" type="checkbox"/>	<input type="checkbox"/>	0-7	10240	Discard	<input type="checkbox"/>	
5	●	●	Down	Automatic	<input checked="" type="checkbox"/>	<input checked="" type="checkbox"/>	<input checked="" type="checkbox"/>	<input checked="" type="checkbox"/>	<input checked="" type="checkbox"/>	<input checked="" type="checkbox"/>	<input type="checkbox"/>	<input type="checkbox"/>	<input type="checkbox"/>	<input type="checkbox"/>	<input checked="" type="checkbox"/>	<input checked="" type="checkbox"/>	<input type="checkbox"/>	0-7	10240	Discard	<input type="checkbox"/>	
6	●	●	Down	Automatic	<input checked="" type="checkbox"/>	<input checked="" type="checkbox"/>	<input checked="" type="checkbox"/>	<input checked="" type="checkbox"/>	<input checked="" type="checkbox"/>	<input checked="" type="checkbox"/>	<input type="checkbox"/>	<input type="checkbox"/>	<input type="checkbox"/>	<input type="checkbox"/>	<input checked="" type="checkbox"/>	<input checked="" type="checkbox"/>	<input type="checkbox"/>	0-7	10240	Discard	<input type="checkbox"/>	
7	●	●	Down	Automatic	<input checked="" type="checkbox"/>	<input checked="" type="checkbox"/>	<input checked="" type="checkbox"/>	<input checked="" type="checkbox"/>	<input checked="" type="checkbox"/>	<input checked="" type="checkbox"/>	<input type="checkbox"/>	<input type="checkbox"/>	<input type="checkbox"/>	<input type="checkbox"/>	<input checked="" type="checkbox"/>	<input checked="" type="checkbox"/>	<input type="checkbox"/>	0-7	10240	Discard	<input type="checkbox"/>	
8	●	●	100fdx	Automatic	<input checked="" type="checkbox"/>	<input checked="" type="checkbox"/>	<input checked="" type="checkbox"/>	<input checked="" type="checkbox"/>	<input checked="" type="checkbox"/>	<input checked="" type="checkbox"/>	<input type="checkbox"/>	<input type="checkbox"/>	<input type="checkbox"/>	<input type="checkbox"/>	<input checked="" type="checkbox"/>	<input checked="" type="checkbox"/>	<input type="checkbox"/>	0-7	10240	Discard	<input type="checkbox"/>	
9	●	●	Down	Automatic	<input checked="" type="checkbox"/>	<input checked="" type="checkbox"/>	<input checked="" type="checkbox"/>	<input checked="" type="checkbox"/>	<input checked="" type="checkbox"/>	<input checked="" type="checkbox"/>	<input type="checkbox"/>	<input type="checkbox"/>	<input type="checkbox"/>	<input type="checkbox"/>	<input checked="" type="checkbox"/>	<input checked="" type="checkbox"/>	<input type="checkbox"/>	0-7	10240	Discard	<input type="checkbox"/>	
10	●	●	Down	Automatic	<input checked="" type="checkbox"/>	<input checked="" type="checkbox"/>	<input checked="" type="checkbox"/>	<input checked="" type="checkbox"/>	<input checked="" type="checkbox"/>	<input checked="" type="checkbox"/>	<input type="checkbox"/>	<input type="checkbox"/>	<input type="checkbox"/>	<input type="checkbox"/>	<input checked="" type="checkbox"/>	<input checked="" type="checkbox"/>	<input type="checkbox"/>	0-7	10240	Discard	<input type="checkbox"/>	
11	●	●	Down	Automatic	<input checked="" type="checkbox"/>	<input checked="" type="checkbox"/>	<input checked="" type="checkbox"/>	<input checked="" type="checkbox"/>	<input checked="" type="checkbox"/>	<input checked="" type="checkbox"/>	<input type="checkbox"/>	<input type="checkbox"/>	<input type="checkbox"/>	<input type="checkbox"/>	<input checked="" type="checkbox"/>	<input checked="" type="checkbox"/>	<input type="checkbox"/>	0-7	10240	Discard	<input type="checkbox"/>	
12	●	●	Down	Automatic	<input checked="" type="checkbox"/>	<input checked="" type="checkbox"/>	<input checked="" type="checkbox"/>	<input checked="" type="checkbox"/>	<input checked="" type="checkbox"/>	<input checked="" type="checkbox"/>	<input type="checkbox"/>	<input type="checkbox"/>	<input type="checkbox"/>	<input type="checkbox"/>	<input checked="" type="checkbox"/>	<input checked="" type="checkbox"/>	<input type="checkbox"/>	0-7	10240	Discard	<input type="checkbox"/>	
13	●	●	Down	Automatic	<input checked="" type="checkbox"/>	<input checked="" type="checkbox"/>	<input checked="" type="checkbox"/>	<input checked="" type="checkbox"/>	<input checked="" type="checkbox"/>	<input checked="" type="checkbox"/>	<input type="checkbox"/>	<input type="checkbox"/>	<input type="checkbox"/>	<input type="checkbox"/>	<input checked="" type="checkbox"/>	<input checked="" type="checkbox"/>	<input type="checkbox"/>	0-7	10240	Discard	<input type="checkbox"/>	
14	●	●	Down	Automatic	<input checked="" type="checkbox"/>	<input checked="" type="checkbox"/>	<input checked="" type="checkbox"/>	<input checked="" type="checkbox"/>	<input checked="" type="checkbox"/>	<input checked="" type="checkbox"/>	<input type="checkbox"/>	<input type="checkbox"/>	<input type="checkbox"/>	<input type="checkbox"/>	<input checked="" type="checkbox"/>	<input checked="" type="checkbox"/>	<input type="checkbox"/>	0-7	10240	Discard	<input type="checkbox"/>	
15	●	●	Down	Automatic	<input checked="" type="checkbox"/>	<input checked="" type="checkbox"/>	<input checked="" type="checkbox"/>	<input checked="" type="checkbox"/>	<input checked="" type="checkbox"/>	<input checked="" type="checkbox"/>	<input type="checkbox"/>	<input type="checkbox"/>	<input type="checkbox"/>	<input type="checkbox"/>	<input checked="" type="checkbox"/>	<input checked="" type="checkbox"/>	<input type="checkbox"/>	0-7	10240	Discard	<input type="checkbox"/>	
16	●	●	Down	Automatic	<input checked="" type="checkbox"/>	<input checked="" type="checkbox"/>	<input checked="" type="checkbox"/>	<input checked="" type="checkbox"/>	<input checked="" type="checkbox"/>	<input checked="" type="checkbox"/>	<input type="checkbox"/>	<input type="checkbox"/>	<input type="checkbox"/>	<input type="checkbox"/>	<input checked="" type="checkbox"/>	<input checked="" type="checkbox"/>	<input type="checkbox"/>	0-7	10240	Discard	<input type="checkbox"/>	
17	●	●	Down	10Gbps FDX	<input checked="" type="checkbox"/>	<input type="checkbox"/>	<input type="checkbox"/>	<input type="checkbox"/>	<input type="checkbox"/>	<input checked="" type="checkbox"/>	<input type="checkbox"/>	<input type="checkbox"/>	<input type="checkbox"/>	<input type="checkbox"/>	<input checked="" type="checkbox"/>	<input checked="" type="checkbox"/>	<input type="checkbox"/>	0-7	10240		<input type="checkbox"/>	auto
18	●	●	Down	10Gbps FDX	<input checked="" type="checkbox"/>	<input type="checkbox"/>	<input type="checkbox"/>	<input type="checkbox"/>	<input type="checkbox"/>	<input checked="" type="checkbox"/>	<input type="checkbox"/>	<input type="checkbox"/>	<input type="checkbox"/>	<input type="checkbox"/>	<input checked="" type="checkbox"/>	<input checked="" type="checkbox"/>	<input type="checkbox"/>	0-7	10240		<input type="checkbox"/>	auto
19	●	●	Down	10Gbps FDX	<input checked="" type="checkbox"/>	<input type="checkbox"/>	<input type="checkbox"/>	<input type="checkbox"/>	<input type="checkbox"/>	<input checked="" type="checkbox"/>	<input type="checkbox"/>	<input type="checkbox"/>	<input type="checkbox"/>	<input type="checkbox"/>	<input checked="" type="checkbox"/>	<input checked="" type="checkbox"/>	<input type="checkbox"/>	0-7	10240		<input type="checkbox"/>	auto
20	●	●	Down	10Gbps FDX	<input checked="" type="checkbox"/>	<input type="checkbox"/>	<input type="checkbox"/>	<input type="checkbox"/>	<input type="checkbox"/>	<input checked="" type="checkbox"/>	<input type="checkbox"/>	<input type="checkbox"/>	<input type="checkbox"/>	<input type="checkbox"/>	<input checked="" type="checkbox"/>	<input checked="" type="checkbox"/>	<input type="checkbox"/>	0-7	10240		<input type="checkbox"/>	auto

Port: This device is managed Gigabit switches with 20 ports. Each logical port number is displayed in a row. The "*" settings will apply actions on all ports.

Link: The current link state for each port is displayed graphically. Green indicates the link is up and red indicates that it is down.

Current Speed: This column provides the current link speed (Auto nego, 10, 100, 1G) and duplex (fdx=Full Duplex, hdx=Half Duplex) of each port.

Configured Speed: This pull down selects any available link speed for the given switch port. Only speed items supported by the specific port are shown.



Possible copper port settings are:

Disabled: Disables the switch port operation.

Automatic: The port auto-negotiates speed with the link partner and selects the highest speed that is compatible with the link partner and negotiates the duplex mode.

10Mbps HDX: Forces the port to 10Mbps half duplex mode.

10Mbps FDX: Forces the port to 10Mbps full duplex mode.

100Mbps HDX: Forces the port to 100Mbps half duplex mode.

100Mbps FDX: Forces the port to 100Mbps full duplex mode.

1Gbps FDX: Forces the port to 1Gbps full duplex mode.

Possible fiber port settings are:

1Gbps FDX: Forces the fiber optic port to 1Gbps full duplex.

10Gbps FDX: Forces the fiber optic port to 10Gbps full duplex mode.

Cable Type: AutoSFP interface in "auto" mode. Automatic SerDes tuning for optical and DAC-3m cables.

DAC-1m: SFP interface in "DAC-1m" mode. Manual SerDes tuning specifically for DAC-1m cables.

DAC-2m: SFP interface in "DAC-2m" mode. Manual SerDes tuning specifically for DAC-2m cables.

DAC-3m: SFP interface in "DAC-3m" mode. Manual SerDes tuning specifically for DAC-3m cables.

DAC-5m: SFP interface in "DAC-5m" mode. Manual SerDes tuning specifically for DAC-5m cables.

Adv Duplex: When duplex is set to Auto (i.e. Auto Negotiation), the port will advertise the specified duplex either FDX or HDX to the link partner. By default, the port will advertise all the supported duplexes if the Duplex is Auto.

Adv Speed: When speed is set to Auto (i.e. Auto Negotiation), the port will advertise the specified speeds either 10M, 100M, 1G or 10G to the link partner. By default, the port will advertise all the supported speeds if the speed is Auto.

Flow Control: The Current Rx column indicates whether pause frames on the port are obeyed, and the Current Tx column indicates whether pause frames on the port are transmitted. The Rx and Tx settings are determined by the result of the last Auto-Negotiation. Check the configured column to use flow control. This setting is also related to the setting for Configured Link Speed.

PFC: When PFC (802.1Qbb Priority Flow Control) is enabled on a port then flow control on a priority level is enabled. Through the Priority field, range (one or more) of priorities can be configured, for example: '0-3,7' which equals '0,1,2,3,7'. PFC is not supported through auto negotiation. PFC and Flowcontrol cannot both be enabled on the same port.

Maximum Frame Size: Enter the maximum frame size allowed for the switch port, including FCS. This switch supports up to 1518~10240 bytes.

Excessive Collision Mode: This setting configures the port transmit collision behavior to either "Discard" (Discard frame after 16 collisions - default) or to "Restart" (Restart backoff algorithm after 16 collisions).

Frame Length Check: An Ethernet frame contains a field EtherType which can be used to indicate the frame payload size (in bytes) for values of 1535 and below. If the EtherType/Length field is above 1535, it indicates that the field is used as an EtherType (indicating which protocol is encapsulated in the payload of the frame). When "frame length check" is enabled, frames with payload size less than 1536 bytes are dropped, if the EtherType/Length field doesn't match the actually payload length. When "frame length check" is disabled, frames are not dropped due to frame length mismatch. Note: No drop counters count frames dropped due to frame length mismatch.

4.4.2 Ports State

Display an overview graphic of the switch.

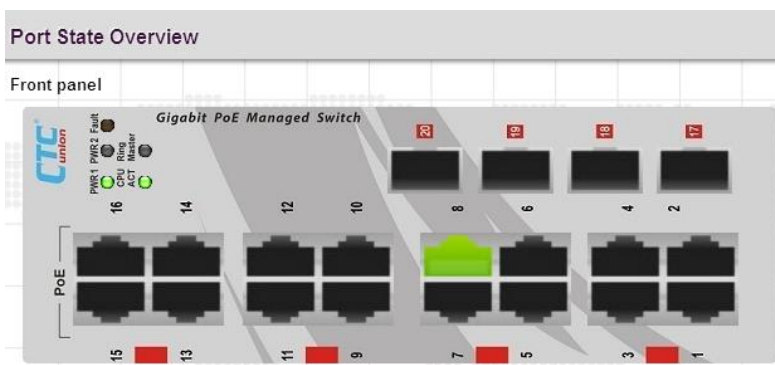

This is the same graphic overview shown when first logging into the switch for management. When "Auto-refresh" is checked, the display will be updated every 3 seconds. "Green" colored ports indicate a linked state of RJ-45 ports; while, "Amber" colored ports indicate a 1G linked state of SFP fiber ports and "Blue" colored ports indicate 10G linked state of SFP fiber ports. "Black" ports have no link and "Gray" ports mean ports are disabled.

4.4.3 Ports Traffic Overview

Displays a comprehensive overview of traffic on all ports.

Port	Packets		Bytes		Errors		Drops		Filtered
	Received	Transmitted	Received	Transmitted	Received	Transmitted	Received	Transmitted	Received
1	0	0	0	0	0	0	0	0	0
2	0	0	0	0	0	0	0	0	0
3	0	0	0	0	0	0	0	0	0
4	0	0	0	0	0	0	0	0	0
5	0	0	0	0	0	0	0	0	0
6	0	0	0	0	0	0	0	0	0
7	0	0	0	0	0	0	0	0	0
8	1795	5503	308222	1416388	0	0	0	0	29
9	0	0	0	0	0	0	0	0	0
10	0	0	0	0	0	0	0	0	0
11	26	51	2814	5355	0	0	0	0	14
12	0	0	0	0	0	0	0	0	0
13	0	0	0	0	0	0	0	0	0
14	0	0	0	0	0	0	0	0	0
15	0	0	0	0	0	0	0	0	0
16	0	0	0	0	0	0	0	0	0
17	0	0	0	0	0	0	0	0	0
18	0	0	0	0	0	0	0	0	0
19	0	0	0	0	0	0	0	0	0
20	0	0	0	0	0	0	0	0	0

The displayed counters are:

Port: The logical port (1~20) for the data contained in the same row.

Packets: The number of received and transmitted packets per port.

Bytes: The number of received and transmitted bytes per port.

Errors: The number of frames received in error and the number of incomplete transmissions per port.

Drops: The number of frames discarded due to ingress or egress congestion.

Filtered: The number of received frames filtered by the forwarding process.

The counter display can be updated by clicking the "Refresh" button. When "Auto-refresh" is checked, the display will be updated every 3 seconds. Clicking the "Clear" button will zero all counters and start counting again.

4.5 Security

Under the security heading are three major icons, switch, access management, network and RADIUS.



4.5.1 Switch

4.5.1.1 Users

This page provides an overview of the current users. Currently the only way to login as another user on the web server is to close and reopen the browser.

User Name	Privilege Level
admin	15

Add New User

By default, there is only one user, 'admin', assigned the highest privilege level of 15.

Click the entries in User Name column to edit the existing users. Or click the "Add New User" button to insert a new user entry.

Add User

User Name: Enter the new user name.

Password: Enter the password for this user account.

Password (again): Retype the password for this user account.

Privilege Level: Select the appropriate privilege level for this user account. The allowed range is 1 to 15. If the privilege level value is 15, it can access all groups, i.e. that is granted the fully control of the device. But other values need to refer to each group privilege level. User's privilege should be same or greater than the group privilege level to have the access of that group. By default setting, most groups privilege level 5 has the read-only access and privilege level 10 has the read-write access. And the system maintenance (software upload, factory defaults and etc.) need user privilege level 15. Generally, the privilege level 15 can be used for an administrator account, privilege level 10 for a standard user account and privilege level 5 for a guest account.

4.5.1.2 Privilege Levels

This page provides an overview of the privilege levels.

Group Name	Privilege Levels			
	Configuration Read-only	Configuration/Execute Read/write	Status/Statistics Read-only	Status/Statistics Read/write
Aggregation	5	10	5	10
Alarm	5	10	5	10
CFM	5	10	5	10
DDMI	5	10	5	10
Debug	15	15	15	15
DHCP	5	10	5	10
DHCPv6_Client	5	10	5	10
Diagnostics	5	10	5	10
ERPS	5	10	5	10
Firmware	5	10	5	10
Green_Ethernet	5	10	5	10
IP	5	10	5	10
IPMC_Snooping	5	10	5	10
LACP	5	10	5	10
LLDP	5	10	5	10
Loop_Protect	5	10	5	10
MAC_Table	5	10	5	10
Miscellaneous	15	15	15	15
MVR	5	10	5	10
NTP	5	10	5	10

POE	5 ▼	10 ▼	5 ▼	10 ▼
Ports	5 ▼	10 ▼	1 ▼	10 ▼
Private_VLANs	5 ▼	10 ▼	5 ▼	10 ▼
QoS	5 ▼	10 ▼	5 ▼	10 ▼
RMirror	5 ▼	10 ▼	5 ▼	10 ▼
Security(access)	10 ▼	10 ▼	5 ▼	10 ▼
Security(network)	5 ▼	10 ▼	5 ▼	10 ▼
Spanning_Tree	5 ▼	10 ▼	5 ▼	10 ▼
System	5 ▼	10 ▼	1 ▼	10 ▼
u-Ring	5 ▼	10 ▼	5 ▼	10 ▼
uFDMA_AIL	5 ▼	10 ▼	5 ▼	10 ▼
uFDMA_CIL	5 ▼	10 ▼	5 ▼	10 ▼
UPnP	5 ▼	10 ▼	5 ▼	10 ▼
VCL	5 ▼	10 ▼	5 ▼	10 ▼
VLAN_Translation	5 ▼	10 ▼	5 ▼	10 ▼
VLANs	5 ▼	10 ▼	5 ▼	10 ▼
XXRP	5 ▼	10 ▼	5 ▼	10 ▼

Save Reset

Group Name: This name identifies the privilege group. In most cases, a privilege level group consists of a single module (e.g. LACP or QoS), but a few of them contains more than one. The following description defines these privilege level groups in details:

System: Contact, Name, Location, Timezone, Daylight Saving Time, Log.

Security: Authentication, System Access Management, Port (contains Dot1x port, MAC based and the MAC Address Limit), ACL, HTTPS, SSH, ARP Inspection, IP source guard.

IP: Everything except 'ping'.

Port: Everything except 'Cable Diagnostics'.

Diagnostics: 'ping' and 'Cable Diagnostics'.

Maintenance: CLI- System Reboot, System Restore Default, System Password, Configuration Save, Configuration Load and Firmware Load. Web- Users, Privilege Levels and everything in Maintenance.

Privilege Levels: Every group has an authorization Privilege level for the following sub groups:

configuration read-only

configuration/execute read-write

status/statistics read-only

status/statistics read-write (e.g. for clearing of statistics)

Please note that User Privilege should be the same or greater than the authorization Privilege level so as to have access to that group.

4.5.1.3 Auth Method

This page allows you to configure how users are authenticated when they log into the switch via one of the management client interfaces.

Authentication Method Configuration

Client	Methods		
console	local	no	no
telnet	local	no	no
ssh	local	no	no
http	local	no	no

Command Authorization Method Configuration

Client	Method	Cmd Lvl	Cfg Cmd
console	no	0	<input type="checkbox"/>
telnet	no	0	<input type="checkbox"/>
ssh	no	0	<input type="checkbox"/>

Accounting Method Configuration

Client	Method	Cmd Lvl	Exec
console	no		<input type="checkbox"/>
telnet	no		<input type="checkbox"/>
ssh	no		<input type="checkbox"/>

Save Reset

Authentication Method Configuration

Client: The management client for which the configuration below applies.

Methods: Method can be set to one of the following values:

no: Authentication is disabled and login is not possible.

local: Use the local user database on the switch for authentication.

radius: Use remote RADIUS server(s) for authentication.

tacacs+: Use remote TACACS+ server(s) for authentication.

NOTE: Methods that involve remote servers will time out if the remote servers are offline. In this case the next method is tried. Each method is tried from left to right and continues until a method either approves or rejects a user. If a remote server is used for primary authentication it is recommended to configure secondary authentication as 'local'. This will enable the management client to login via the local user database if none of the configured authentication servers are alive.

Command Authentication Method Configuration

Client: The management client for which the configuration below applies.

Methods: Method can be set to one of the following values:

no: Authentication is disabled and login is not possible.

local: Use the local user database on the switch for authentication.

radius: Use remote RADIUS server(s) for authentication.

tacacs+: Use remote TACACS+ server(s) for authentication.

Cmd Lvl: Authorize all commands with a privilege level higher than or equal to this level.

Cfg cmd: Authorize configuration commands.

Accounting Method Configuration

Client: The management client for which the configuration below applies.

Methods: Method can be set to one of the following values:

no: Authentication is disabled and login is not possible.

local: Use the local user database on the switch for authentication.

radius: Use remote RADIUS server(s) for authentication.

tacacs+: Use remote TACACS+ server(s) for authentication.

Cmd Lvl: Authorize all commands with a privilege level higher than or equal to this level.

Exec: Enable Exec (login) accounting.

4.5.1.4 SSH

Configure SSH on this page.

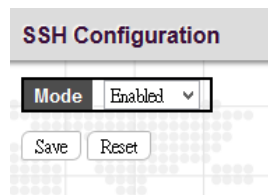

Mode: Indicates the SSH mode operation. Possible modes are:

Enabled: Enable SSH mode operation. By default, SSH mode operation is enabled.

Disabled: Disable SSH mode operation.

NOTE: SSH is preferred to Telnet, unless the management network is trusted. Telnet passes authentication credentials in plain text, making those credentials susceptible to packet capture and analysis. SSH provides a secure authentication method. The SSH in this device uses version 2 of SSH protocol.

4.5.1.5 HTTPS

Configure HTTPS on this page.

The screenshot shows two web forms. The first form, titled "HTTPS Configuration", has two dropdown menus: "Mode" set to "Disabled" and "Automatic Redirect" set to "Disabled". Below these are "Save" and "Reset" buttons. The second form, titled "HTTPS Certificate Update", has two "Choose File" buttons for "Certificate File" and "Private Key File", both showing "No file chosen". There is a text input field for "Pass Phrase" and a "Certificate Status" field displaying "Switch secure HTTP certificate is presented". At the bottom are "Upload", "Reset", and "Generate Certificate" buttons.

HTTPS Configuration

Mode: Indicates the HTTPS operation mode. When the current connection is HTTPS and HTTPS mode operation is disabled, web browser will automatically redirect to an HTTP connection. Possible modes are:

Enabled: Enable HTTPS mode operation.

Disabled: Disable HTTPS mode operation.

Automatic Redirect: Indicates the HTTPS redirect mode operation. It applies only if HTTPS mode "Enabled" is selected. Automatically redirects HTTP of web browser to an HTTPS connection when both HTTPS mode and Automatic Redirect are enabled. Possible modes are:

Enabled: Enable HTTPS redirect mode operation.

Disabled: Disable HTTPS redirect mode operation.

HTTPS Certificate Update

Certificate File: Select a HTTPS certificate to upload

Private Key File: Select a private key file to upload.

Pass Phrase: If your uploaded certificate is protected by a pass phrase, enter the pass phrase here. The allowed string length is 0 to 60.

Certificate Status: This field shows the current status of the uploaded certificate.

4.5.2 Access Management

4.5.2.1 Access Management Configuration

Configure the access management table on this page. The maximum number of entries is 16. If the application's type matches any one of the access management entries, it will be allowed access to the switch.

Access Management Configuration

Mode:

Delete	VLAN ID	Start IP Address	End IP Address	HTTP/HTTPS	SNMP	TELNET/SSH
<input type="button" value="Delete"/>	1	192.168.0.49	192.168.0.49	<input checked="" type="checkbox"/>	<input checked="" type="checkbox"/>	<input checked="" type="checkbox"/>

Mode: Indicates the access management mode operation. Possible modes are:

Enabled: Enable access management mode operation.

Disabled: Disable access management mode operation.

VLAN ID: Indicates the VLAN ID for the access management entry.

Start IP address: Indicates the start IP address for the access management entry.

End IP address: Indicates the end IP address for the access management entry.

HTTP/HTTPS: Checked indicates that the matched host can access the switch from HTTP/HTTPS interface.

SNMP: Checked indicates that the matched host can access the switch from SNMP.

TELNET/SSH: Indicates that the matched host can access the switch from TELNET/SSH interface.

Click the button to insert a new entry to the list.

Click the button to remove a newly-inserted entry or select the checkbox to remove a saved entry during the next save.

Click the button to save settings or changes.

Click the button to restore changed settings to the default settings.

4.5.2.2 Access Management Statistics

This page provides statistics for access management.

Access Management Statistics			
Interface	Received Packets	Allowed Packets	Discarded Packets
HTTP	0	0	0
HTTPS	0	0	0
SNMP	0	0	0
TELNET	0	0	0
SSH	0	0	0

Interface: The interface type through which any remote host can access the switch.

Received Packets: The number of received packets from the interface when access management mode is enabled.

Allowed Packets: The number of allowed packets from the interface when access management mode is enabled.

Discarded Packets: The number of discarded packets from the interface when access management mode is enabled.

4.5.2.3 SNMP

4.5.2.3.1 SNMP System Configuration

SNMP System Configuration	
Mode	Enabled
Engine ID	80001294030002ab062020
<input type="button" value="Save"/> <input type="button" value="Reset"/>	

SNMP System Configuration

Mode: Indicates the SNMP mode operation. Possible modes are:

Enabled: Enable SNMP mode (SNMPv1, v2c, v3) operation .

Disabled: Disable SNMP mode operation.

Engine ID: Indicates the SNMPv3 engine ID. The string must contain an even number (in hexadecimal format) with number of digits between 10 and 64, but all-zeros and all-'F's are not allowed. Changes to the Engine ID will clear all original local users.

4.5.2.3.2 Trap Configuration

4.5.2.3.2.1 Trap Destinations

Configure SNMP trap on this page.

SNMP Trap Configuration	
Trap Config Name	<input type="text"/>
Trap Mode	Disabled
Trap Version	SNMP v2c
Trap Community	public
Trap Destination Address	<input type="text"/>
Trap Destination Port	162
Trap Inform Mode	Disabled
Trap Inform Timeout (seconds)	3
Trap Inform Retry Times	5
Trap Security Engine ID	80001294030002ab062020
Trap Security Name	None
<input type="button" value="Save"/> <input type="button" value="Reset"/>	

Trap Config Name: Indicates a configuration name for this trap. The allowed string length is 1 to 32 and the allowed content is ASCII characters from 33 to 126.

Trap Mode: Indicates the SNMP trap mode operation. Possible modes are:

Enabled: Enable SNMP trap mode operation.

Disabled: Disable SNMP trap mode operation.

Trap Version: Indicates the SNMP trap supported version. Possible versions are:

SNMP v1: Set SNMP trap supported version 1.

SNMP v2c: Set SNMP trap supported version 2c.

SNMP v3: Set SNMP trap supported version 3.

Trap Community: Indicates the community access string when sending SNMP trap packet. The allowed string length is 0 to 255, and the allowed content is ASCII characters from 0x21 to 0x7E.

Trap Destination Address: Indicates the SNMP trap destination address. It allows a valid IP address in dotted decimal notation ('x.y.z.w'). Also allowed is a valid hostname. A valid hostname is a string drawn from the alphabet (A-Za-z), digits (0-9), dot (.) and dash (-). Spaces are not allowed. The first character must be an alpha character, and the first and last characters cannot be a dot or a dash.

Trap Destination Address: Indicates the SNMP trap destination address. It allow a valid IP address in dotted decimal notation ('x.y.z.w'). And it also allow a valid hostname. A valid hostname is a string drawn from the alphabet (A-Za-z), digits (0-9), dot (.), dash (-). Spaces are not allowed, the first character must be an alpha character, and the first and last characters must not be a dot or a dash.

Indicates the SNMP trap destination IPv6 address. IPv6 address is in 128-bit records represented as eight fields of up to four hexadecimal digits with a colon separating each field (:). For example, 'fe80::215:c5ff:fe03:4dc7'. The symbol

'::' is a special syntax that can be used as a shorthand way of representing multiple 16-bit groups of contiguous zeros; but it can appear only once. It can also represent a legally valid IPv4 address. For example, '::192.1.2.34'.

Trap Destination Port: Indicates a SNMP destination port number. SNMP Agent will send SNMP message via this port. The port range is 1~65535.

Trap Inform Mode: Indicates the SNMP trap inform mode operation. Possible modes are:

Enabled: Enable SNMP trap inform mode operation.

Disabled: Disable SNMP trap inform mode operation.

Trap Inform Timeout (seconds): Indicates the SNMP trap inform timeout. The allowed range is 0 to 2147.

Trap Inform Retry Times: Indicates the SNMP trap inform retry times. The allowed range is 0 to 255.

Trap Security Engine ID: Indicates the SNMP trap security engine ID. SNMPv3 sends traps and informs use USM for authentication and privacy. A unique engine ID for these traps and informs is needed. When "Trap Probe Security Engine ID" is enabled, the ID will be probed automatically. Otherwise, the ID specified in this field is used. The string must contain an even number (in hexadecimal format) with number of digits between 10 and 64, but all-zeros and all-'F's are not allowed.

Trap Security Name: Indicates the SNMP trap security name. SNMPv3 traps and informs use USM for authentication and privacy. A unique security name is needed when traps and informs are enabled.

4.5.2.3.2.2 Sources

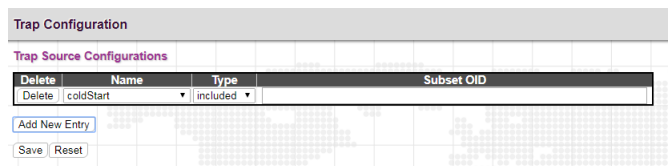

Name: Indicate the trap source name of the entry.

Type: Indicates the trap source type that this entry should belong to. Possible view types are:

included: An optional flag to indicate a trap source is sent or the given trap source is matched.

excluded: An optional flag to indicate a trap source is not sent for the given trap source is matched.

Subset OID: Indicate the subset OID for the entry. The allowed OID length is 1 to 128. The allowed string content is digital number or an asterisk(*).

4.5.2.3.3 SNMPv3 Community Configuration

Configure SNMPv3 community table on this page. The entry index key is Community.

Delete	Community name	Community secret	Source IP	Source Prefix
<input type="checkbox"/>	public	public	0.0.0.0	0
<input type="checkbox"/>	private	private	0.0.0.0	0

Buttons: Add New Entry, Save, Reset

Community name: Indicates the security name to map the community to the SNMP Groups information. The allowed string length is 1 to 32, and the allowed content is ASCII characters from 33 to 126.

Community secret: Indicates the community access string to permit access using SNMPv1 and SNMPv2c to the SNMP agent. The allowed string length is 1 to 32, and the allowed content is ASCII characters from 33 to 126. This string is case sensitive.

Source IP: Indicates the SNMP access source address. A particular range of source addresses can be used to restrict source subnet when combined with source mask.

Source Mask: Indicates the SNMP access source address mask.

4.5.2.3.4 SNMPv3 User Configuration

Configure SNMPv3 user table on this page. The entry index keys are Engine ID and User Name.

Delete	Engine ID	User Name	Security Level	Authentication Protocol	Authentication Password	Privacy Protocol	Privacy Password
<input type="checkbox"/>	800007e5017f000001	default_user	NoAuth, NoPriv	None	None	None	None

Buttons: Add New Entry, Save, Reset

Engine ID: An octet string identifying the engine ID that this entry should belong to. The string must contain an even number (in hexadecimal format) with number of digits between 10 and 64, but all-zeros and all-'F's are not allowed. The SNMPv3 architecture uses the User-based Security Model (USM) for message security and the View-based Access Control Model (VACM) for access control. For the USM entry, the usmUserEngineID and usmUserName are the entry's keys. In a simple agent, usmUserEngineID is always that agent's own snmpEngineID value. The value can also take the value of the snmpEngineID of a remote SNMP engine with which this user can communicate. In other words, if user engine ID equal system engine ID then it is local user; otherwise it is a remote user.

User Name: A string identifying the user name that this entry should belong to. The allowed string length is 1 to 32, and the allowed content is ASCII characters from 0x21 to 0x7E.

Security Level: Indicates the security model that this entry should belong to. Possible security models are:

NoAuth, NoPriv: No authentication and no privacy.

Auth, NoPriv: Authentication and no privacy.

Auth, Priv: Authentication and privacy.

The value of security level cannot be modified if entry already exists. That means it must first be ensured that the value is set correctly.

Authentication Protocol: Indicates the authentication protocol that this entry should belong to. Possible authentication protocols are:

None: No authentication protocol.

MD5: An optional flag to indicate that this user uses MD5 authentication protocol.

SHA: An optional flag to indicate that this user uses SHA authentication protocol.

The value of security level cannot be modified if entry already exists. That means it must first be ensured that the value is set correctly.

Authentication Password: A string identifying the authentication password phrase. For MD5 authentication protocol, the allowed string length is 8 to 32 characters. For SHA authentication protocol, the allowed string length is 8 to 40 characters. The allowed content is ASCII characters from 0x21 to 0x7E.

Privacy Protocol: Indicates the privacy protocol that this entry should belong to. Possible privacy protocols are:

None: No privacy protocol.

DES: An optional flag to indicate that this user uses DES authentication protocol.

AES: An optional flag to indicate that this user uses AES authentication protocol.

Privacy Password: A string identifying the privacy password phrase. The allowed string length is 8 to 32, and the allowed content is ASCII characters from 0x21 to 0x7E.

Click the “Add New Entry” button to insert a new entry to the list.

Click the “Delete” button to remove a newly-inserted entry or select the checkbox to remove a saved entry during the next save.

Click the “Save” button to save settings or changes.

Click the “Reset” button to restore changed settings to the default settings.

4.5.2.3.5 SNMPv3 Group Configuration

Configure SNMPv3 group table on this page. The entry index keys are Security Model and Security Name.

SNMPv3 Group Configuration			
Delete	Security Model	Security Name	Group Name
<input type="checkbox"/>	v1	public	default_ro_group
<input type="checkbox"/>	v1	private	default_rw_group
<input type="checkbox"/>	v2c	public	default_ro_group
<input type="checkbox"/>	v2c	private	default_rw_group
<input type="checkbox"/>	usm	default_user	default_rw_group

Add New Entry
Save
Reset

Security Model: Indicates the security model that this entry should belong to. Possible security models are:

v1: Reserved for SNMPv1.

v2c: Reserved for SNMPv2c.

usm: User-based Security Model (USM) for SNMPv3.

Security Name: A string identifying the security name that this entry should belong to. The allowed string length is 1 to 32, and the allowed content is ASCII characters from 0x21 to 0x7E.

Group Name: A string identifying the group name that this entry should belong to. The allowed string length is 1 to 32, and the allowed content is ASCII characters from 0x21 to 0x7E.

4.5.2.3.6 SNMPv3 View Configuration

Configure SNMPv3 view table on this page. The entry index keys are View Name and OID Subtree.

Delete	View Name	View Type	OID Subtree
<input type="checkbox"/>	default_view	included	.1

Add New Entry Save Reset

View Name: A string identifying the view name that this entry should belong to. The allowed string length is 1 to 32, and the allowed content is ASCII characters from 0x21 to 0x7E.

View Type: Indicates the view type that this entry should belong to. Possible view types are:

included: An optional flag to indicate that this view subtree should be included.

excluded: An optional flag to indicate that this view subtree should be excluded. In general, if a view entry's view type is 'excluded', there should be another view entry existing with view type as 'included' and it's OID subtree should overstep the 'excluded' view entry.

OID Subtree: The OID defining the root of the subtree to add to the named view. The allowed OID length is 1 to 128. The allowed string content is digital number or an asterisk(*).

4.5.2.3.7 SNMPv3 Access Configuration

Configure SNMPv3 access table on this page. The entry index keys are Group Name, Security Model and Security Level.

Delete	Group Name	Security Model	Security Level	Read View Name	Write View Name
<input type="checkbox"/>	default_ro_group	any	NoAuth, NoPriv	default_view	None
<input type="checkbox"/>	default_rw_group	any	NoAuth, NoPriv	default_view	default_view

Add New Entry Save Reset

Delete: Check to delete the entry. It will be deleted during the next save.

Group Name: A string identifying the group name that this entry should belong to. The allowed string length is 1 to 32, and the allowed content is ASCII characters from 0x21 to 0x7E.

Security Model: Indicates the security model that this entry should belong to. Possible security models are:

any: Any security model accepted(v1|v2c|usm).

v1: Reserved for SNMPv1.

v2c: Reserved for SNMPv2c.

usm: User-based Security Model (USM) for SNMPv3.

Security Level: Indicates the security level that this entry should belong to. Possible security models are:

NoAuth, NoPriv: No authentication and no privacy.

Auth, NoPriv: Authentication and no privacy.

Auth, Priv: Authentication and privacy.

Read View Name: The name of the MIB view defining the MIB objects for which this request may request the current values. The allowed string length is 1 to 32, and the allowed content is ASCII characters from 0x21 to 0x7E.

Write View Name: The name of the MIB view defining the MIB objects for which this request may potentially set new values. The allowed string length is 1 to 32, and the allowed content is ASCII characters from 0x21 to 0x7E.

4.5.2.4 RMON

4.5.2.4.1 RMON Statistics Configuration

Configure RMON Statistics table on this page. The entry index key is ID.

Delete	ID	Data Source
Delete		.1.3.6.1.2.1.2.2.1.1.

Add New Entry Save Reset

Delete: Check to delete the entry. It will be deleted during the next save.

ID: Indicates the index of the entry. The range is from 1 to 65535.

Data Source: Indicates the port ID which wants to be monitored.

4.5.2.4.2 RMON History Configuration

RMON History Configuration is to collect statistics on a physical interface to monitor network utilization, packet types, and errors. A RMON historical record can be used to monitor intermittent problems.

Delete	ID	Data Source	Interval	Buckets	Buckets Granted
Delete		.1.3.6.1.2.1.2.2.1.1.	1800	50	

Add New Entry Save Reset

ID: Indicates the index of the entry. The range is from 1 to 65535.

Data Source: Indicates the port ID which wants to be monitored.

Interval: Indicates the polling interval. By default, 1800 seconds is specified. The allowed range is 1~3600 seconds.

Buckets: The number of buckets requested for this entry. By default, 50 is specified. The allowed range is 1~3600.

Buckets Granted: The number of buckets granted.

Click the “Add New Entry” button to insert a new entry to the list.

Click the “Delete” button to remove a newly-inserted entry or select the checkbox to remove a saved entry during the next save.

Click the “Save” button to save settings or changes.

Click the “Reset” button to restore changed settings to the default settings.

4.5.2.4.3 RMON Alarm Configuration

RMON Alarm configuration defines specific criteria that will generate response events. It can be set to test data over any specified time interval and can monitor absolute or changing values. Alarms can also be set to respond to rising or falling thresholds.

RMON Alarm Configuration										
Delete	ID	Interval	Variable	Sample Type	Value	Startup Alarm	Rising Threshold	Rising Index	Falling Threshold	Falling Index
Delete		30	.1.3.6.1.2.1.2.2.1.	0,0	Delta	0	RisingOrFalling	0	0	0
<input type="button" value="Add New Entry"/> <input type="button" value="Save"/> <input type="button" value="Reset"/>										

ID: Indicates the index of the entry. The range is from 1 to 65535.

Interval: The polling interval for sampling and comparing the rising and falling threshold. The range is from 1 to 2³¹ seconds.

Variable: The object number of the MIB variable to be sampled. Only variables of the type ifEntry.n.n may be sampled. Possible variables are InOctets, InUcastPkts, InNUcastPkts, InDiscards, InErrors, InUnknownProtos, OutOctets, OutUcastPkts, OutNUcastPkts, OutDiscards, OutErrors, and OutQLen.

Sample Type: Test for absolute or relative change in the specified variable.

Absolute: The variable is compared to the thresholds at the end of the sampling period.

Delta: The last sample is subtracted from the current value and the difference is compared to the thresholds.

Value: The statistic value during the last sampling period.

Startup Alarm: Select a method that is used to sample the selected variable and calculate the value to be compared against the thresholds.

Rising or Falling: Trigger alarm when the first value is larger than the rising threshold or less than the falling threshold.

Rising: Trigger alarm when the first value is larger than the rising threshold.

Falling: Trigger alarm when the first value is less than the falling threshold.

Rising Threshold: If the current value is greater than the rising threshold and the last sample value is less than this threshold, then an alarm will be triggered. After a rising event has been generated, another such event will not be generated until the sampled value has fallen below the rising threshold, reaches the falling threshold, and again moves back up to the rising threshold. The threshold range is -2147483647 to 2147483647.

Rising Index: Indicates the rising index of an event. The range is 1~65535.

Falling Threshold: If the current value is less than the falling threshold, and the last sample value was greater than this threshold, then an alarm will be generated. After a falling event has been generated, another such event will not be generated until the sampled value has risen above the falling threshold, reaches the rising threshold, and again moves back down to the failing threshold. (Range: -2147483647 to 2147483647)

Falling Index: Indicates the falling index of an event. The range is 1~65535.

Click the “Add New Entry” button to insert a new entry to the list.

Click the “Delete” button to remove a newly-inserted entry or select the checkbox to remove a saved entry during the next save.

Click the “Save” button to save settings or changes.

Click the “Reset” button to restore changed settings to the default settings.

4.5.2.4.4 RMON Event Configuration

RMON Event Configuration page is used to set an action taken when an alarm is triggered.

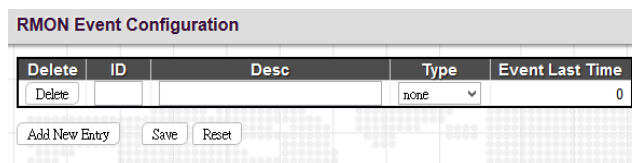

Delete: Check to delete the entry. It will be deleted during the next save.

ID: Specify an ID index. The range is 1~65535.

Desc: Enter a descriptive comment for this entry.

Type: Select an event type that will take when an alarm is triggered.

None: No event is generated.

Log: When the event is triggered, a RMON log entry will be generated.

snmptrap: Sends a trap message to all configured trap managers.

logandtrap: Logs an event and sends a trap message.

Event Last Time: The value of sysUpTime when an event was last generated for this entry.

4.5.2.4.5 RMON Statistics Overview

This RMON statistics overview page shows interface statistics. All values displayed have been accumulated since the last system reboot and are shown as counts per second. The system will automatically refresh every 60 seconds by default.

RMON Statistics Status Overview																		
Auto-refresh <input type="checkbox"/> Refresh << >>																		
Start from Control Index <input type="text" value="0"/> with <input type="text" value="20"/> entries per page.																		
ID	Data Source (ifindex)	Drop	Octets	Pkts	Broad-cast	Multi-cast	CRC Errors	Under-size	Over-size	Frag.	Jabb.	Coll.	64 Bytes	65 ~ 127	128 ~ 255	256 ~ 511	512 ~ 1023	1024 ~ 1588
No more entries																		

ID: Display an ID index.

Data Source: Port ID to Monitor.

Drop: The total number of dropped packets due to lack of resources.

Octets: The total number of octets of data received.

Pkts: The total number of packets (including bad packets, broadcast packets) received.

Broadcast: The total number of good packets received that were directed to the broadcast address.

Multicast: The total number of good packets received that were directed to a multicast address.

CRC Errors: The total number of packets received that had a length (excluding framing bits, but including FCS octets) of between 64 and 1518 octets.

Undersize: The total number of packets received that were less than 64 octets.

Oversize: The total number of packets received that were longer than 1518 octets.

Frag.: The number of frames which size is less than 64 octets received with invalid CRC.

Jabb.: The number of frames which size is larger than 64 octets received with invalid CRC.

Coll.: The best estimate of the total number of collisions on this Ethernet segment.

64 Bytes: The total number of packets (including bad packets) received that were 64 octets in length.

X~Y (65~127, 128~255, 256~511, 512~1023, 1024~1588): The total number packets received between X and Y octets in length.

4.5.2.4.6 History Overview

RMON History Overview														
Auto-refresh <input type="checkbox"/> Refresh << >>														
Start from Control Index <input type="text" value="0"/> and Sample Index <input type="text" value="0"/> with <input type="text" value="20"/> entries per page.														
History Index	Sample Index	Sample Start	Drop	Octets	Pkts	Broad-cast	Multi-cast	CRC Errors	Under-size	Over-size	Frag.	Jabb.	Coll.	Utilization
No more entries														

History Index: Display Index of History control entry.

Sample Index: Display Index of the data entry associated with the control entry.

Sample Start: The time at which this sample started, expressed in seconds since the switch booted up.

Drop: The total number of dropped packets due to lack of resources.

Octets: The total number of octets of data received.

Pkts: The total number of packets (including bad packets, broadcast packets) received.

Broadcast: The total number of good packets received that were directed to the broadcast address.

Multicast: The total number of good packets received that were directed to a multicast address.

CRC Errors: The total number of packets received that had a length (excluding framing bits, but including FCS octets) of between 64 and 1518 octets.

Undersize: The total number of packets received that were less than 64 octets.

Oversize: The total number of packets received that were longer than 1518 octets.

Frag.: The number of frames which size is less than 64 octets received with invalid CRC.

Jabb.: The number of frames which size is larger than 64 octets received with invalid CRC.

Coll.: The best estimate of the total number of collisions on this Ethernet segment.

Utilization: The best estimate of the mean physical layer network utilization on this interface during this sampling interval, in hundredths of a percent.

4.5.2.4.7 Alarm Overview

RMON Alarm Overview									
Auto-refresh <input type="checkbox"/> Refresh << >>									
Start from Control Index <input type="text" value="0"/> with <input type="text" value="20"/> entries per page.									
ID	Interval	Variable	Sample Type	Value	Startup Alarm	Rising Threshold	Rising Index	Falling Threshold	Falling Index
No more entries									

ID: Display an alarm control index.

Interval: Interval in seconds for sampling and comparing the rising and falling threshold.

Variable: MIB object that is used to be sampled.

Sample Type: The method of sampling the selected variable and calculating the value to be compared against the thresholds.

Value: The value of the statistic during the last sampling period.

Startup Alarm: The alarm that may be triggered when this entry is first set to valid.

Rising Threshold: If the current value is greater than the rising threshold, and the last sample value was less than this threshold, then an alarm will be generated.

Rising Index: The index of the event to use if an alarm is triggered by monitored variables crossing above the rising threshold.

Falling Threshold: If the current value is less than the falling threshold, and the last sample value was greater than this threshold, then an alarm will be generated.

Falling Index: The index of the event to use if an alarm is triggered by monitored variables crossing below the falling threshold.

4.5.2.4.8 Event Overview

RMON Event Overview			
Start from Control Index <input type="text" value="0"/> and Sample Index <input type="text" value="0"/> with <input type="text" value="20"/> entries per page.			
Event Index	LogIndex	LogTime	LogDescription
No more entries			

Event Index: Display the event entry index.

Log Index: Display the log entry index.

Log Time: Display Event log time.

Log Description: Display Event description.

4.5.3 Network

4.5.3.1 Port Security

4.5.3.1.1 Configuration

Port Security Limit Control can restrict the number of users that can access the switch based on users' MAC address and VLAN ID on a per port basis. Once the number of users that wants to access the switch exceeds the specified number, a selected action will be taken immediately.

Port Security Configuration						
Global Configuration						
Aging Enabled	<input type="checkbox"/>					
Aging Period	3600	seconds				
Hold Time	300	seconds				
Port Configuration						
Port	Mode	Limit	Violation Mode	Violation Limit	State	
*	<>	4	<>	4	Disabled	
1	Disabled	4	Protect	4	Disabled	
2	Disabled	4	Protect	4	Disabled	
3	Disabled	4	Protect	4	Disabled	
4	Disabled	4	Protect	4	Disabled	
5	Disabled	4	Protect	4	Disabled	
6	Disabled	4	Protect	4	Disabled	
7	Disabled	4	Protect	4	Disabled	
8	Disabled	4	Protect	4	Disabled	
9	Disabled	4	Protect	4	Disabled	
10	Disabled	4	Protect	4	Disabled	
11	Disabled	4	Protect	4	Disabled	
12	Disabled	4	Protect	4	Disabled	
13	Disabled	4	Protect	4	Disabled	
14	Disabled	4	Protect	4	Disabled	
15	Disabled	4	Protect	4	Disabled	
16	Disabled	4	Protect	4	Disabled	
17	Disabled	4	Protect	4	Disabled	
18	Disabled	4	Protect	4	Disabled	
19	Disabled	4	Protect	4	Disabled	
20	Disabled	4	Protect	4	Disabled	

System Configuration

Aging Enabled: If enabled, secured MAC addresses are subject to aging as discussed under Aging Period. With aging enabled, a timer is started once the end-host gets secured. When the timer expires, the switch starts looking for frames from the end-host, and if such frames are not seen within the next Aging Period, the end-host is assumed to be disconnected, and the corresponding resources are freed on the switch.

Aging Period: If Aging Enabled is checked, then the aging period can be set up with the desired value. By default, the aging period is set to 3600 seconds. The allowed range is 10 - 10,000,000 second.

Hold Time: Configure a desired hold time value in seconds. This value is used to determine how long a MAC address is held in the MAC table if it has been found to vilate the limit. The default value 300 seconds but can be changed to the desired value from 10 to 10000000 seconds. The reason for holding a violating MAC address in MAC table is primarily to ensure that the same MAC address doesn't give rise to continuous notifications (if notifications on violation count is enabled).

Port Configuration

Port: Display the port number. "Port *" rules apply to all ports.

Mode: Enable or disable port security limit control on a per port basis. To make limit control function work, port security limit control needs to be enabled globally and on a port.

Limit: The maximum number of MAC addresses that can be secured on this port. The number cannot exceed 1024. If the limit is exceeded, the corresponding action is taken.

Violation Mode: If the limit is exceeded, the selected action will take effect.

protect: Do not allow more than the specified limit of MAC addresses to access on a port. No action is further taken.

restrict: If Limit is reached, subsequent MAC addresses on the port will be counted and marked as violating. Such MAC addresses are removed from the MAC table when the hold time expires.

shutdown: If Limit + 1 MAC addresses is seen on the port, shut down the port. This implies that all secured MAC addresses will be removed from the port, and no new addresses will be learned. Even if the link is physically disconnected and reconnected on the port (by disconnecting the cable), the port will remain shut down. There are three ways to re-open the port:

- * Boot the switch
- * Disable and re-enable Limit Control on the port or the switch
- * Click the "Reopen" button

Violation Limit: The maximum number of MAC addresses that can be marked as violating on the port. This number cannot exceed 1024. The default is 4. It is only used when Violation Mode is Restrict.

State: Display the current state of the port from the port security limit control's point of view. The displayed state might be one of the following:

Disabled: Limit control is either globally disabled or disabled on a port.

Ready: The limit is not reached yet.

Limit Reached: The limit is reached on a port. This state can only be shown if Action is set to None or Trap.

Shutdown: The port is shut down by the Limit Control module. This state can only be shown if Action is set to Shutdown or Trap & Shutdown.

4.5.3.1.2 Static and Sticky MAC Addresses

Delete	Port	VLAN ID	MAC Address	Type
Delete	Select ... ▼	1	00:00:00:00:00:00	Static ▼

Add New MAC Entry

Save Reset

Delete: Remove this entry from the list.

Port: Select the port to which this MAC address is bound.

VLAN ID: Specify the VLAN ID.

MAC Address: Specify the MAC address that bounds to the specified port.

Type: Select the type of the entry which could be Static or Sticky.

Static: A static MAC address is the address added by end-user. Static addresses are not subject to aging and will be added to MAC address table once Port Security gets enabled on the interface. Static entries are part of the running-config and will survive interface link state changes and reboots if saved to startup-config. Static entries can be added to the running-config at any time whether or not Port Security is enabled.

Sticky: When the interface is in Sticky mode, all entries would otherwise have learned as dynamic are learned as Sticky. Like static entries, sticky entries are part of the running-config and will survive interface link state changes and reboots if saved to startup-config. Though not the intention with the sticky entries, they can be added by management to the running-config at any time whether or not Port Security is enabled on the

interface, as long as the interface is in Sticky mode. Sticky entries will disappear if the interface is taken out of Sticky mode.

4.5.3.1.3 Switch Status

Port Security Switch Status									
User Module Legend									
User Module Name	Abbr								
Port Security (Admin)	P								
802.1X	8								
Voice VLAN	V								
Port Status									
Clear	Port	Users	Violation Mode	State	MAC Count				
					Current	Violating	Limit		

Clear	1	---	Disabled	Disabled	-	-	-
Clear	2	---	Disabled	Disabled	-	-	-
Clear	3	---	Disabled	Disabled	-	-	-
Clear	4	---	Disabled	Disabled	-	-	-
Clear	5	---	Disabled	Disabled	-	-	-
Clear	6	---	Disabled	Disabled	-	-	-
Clear	7	---	Disabled	Disabled	-	-	-
Clear	8	---	Disabled	Disabled	-	-	-
Clear	9	---	Disabled	Disabled	-	-	-
Clear	10	---	Disabled	Disabled	-	-	-
Clear	11	---	Disabled	Disabled	-	-	-
Clear	12	---	Disabled	Disabled	-	-	-
Clear	13	---	Disabled	Disabled	-	-	-
Clear	14	---	Disabled	Disabled	-	-	-
Clear	15	---	Disabled	Disabled	-	-	-
Clear	16	---	Disabled	Disabled	-	-	-
Clear	17	---	Disabled	Disabled	-	-	-
Clear	18	---	Disabled	Disabled	-	-	-
Clear	19	---	Disabled	Disabled	-	-	-
Clear	20	---	Disabled	Disabled	-	-	-

User Module Legend

User Module Name: The full name of a module that may request Port Security services.

Abbr: This column is the abbreviation for the user module used in the “Users” column in the “Port Status”.

Port Status

Port: Port number. Click a particular port number to see its port status.

Users: Each of the user modules has a column that shows whether that module has enabled Port Security or not. A '-' means that the corresponding user module is not enabled, whereas a letter indicates that the user module abbreviated by that letter has enabled port security.

Violation Mode: This shows the configured violation mode of a specific port. It can be one of the four values, these are Disabled, Protect, Restrict & Shutdown.

State: This shows the current status of a port. It can be one of the following states:

Disabled: No user modules are currently using the Port Security service.

Ready: The Port Security service is in use by at least one user module, and is awaiting frames from unknown MAC addresses to arrive.

Limit Reached: The Port Security service is enabled by at least the Limit Control user module, and that module has indicated that the limit is reached and no more MAC addresses should be taken in.

Shutdown: The Port Security service is enabled by at least the Limit Control user module and that module has indicated that the limit is exceeded. No MAC addresses can be learned on the port until it is administratively re-opened on the Limit Control configuration page.

MAC Count (Current/Violating/Limit): The three columns indicate the number of currently learned MAC addresses (forwarding as well as blocked), the number of violating MAC address (only counting in Restrict mode) and the

maximum number of MAC addresses that can be learned on the port, respectively. If no user modules are enabled on the port, the Current column will show a dash (-). If the Limit Control user module is not enabled on the port, the Limit column will show a dash (-).

4.5.3.1.4 Details

Delete	Port	VLAN ID	MAC Address	Type	State	Age/Hold
No MAC addresses attached						

This page shows MAC addresses learned on a particular port.

MAC Address: When “Port Security Limit Control” is enabled globally and on a port, MAC addresses learned on a port show in here.

VLAN ID: Display VLAN ID that is seen on this port.

State: Display whether the corresponding MAC address is forwarding or blocked. In the blocked state, it will not be allowed to transmit or receive traffic.

Age/Hold: If at least one user module has decided to block this MAC address, it will stay in the blocked state until the hold time (measured in seconds) expires. If all user modules have decided to allow this MAC address to forward, and aging is enabled, the Port Security module will periodically check that this MAC address is still forwarding traffic. If the age period (measured in seconds) expires and no frames have been seen, the MAC address will be removed from the MAC table. Otherwise a new age period will begin. If aging is disabled or a user module has decided to hold the MAC address indefinitely, a dash (-) will be shown.

4.5.3.2 NAS

Network Access Server configuration is useful to the networking environment that wants to authenticate clients (suplicants) before they can access resources on the protected network. To effectively control access to unknown clients, 802.1X defined by IEEE provides a port-based authentication procedure that can prevent unauthorized access to a network by requiring users to first submit credentials for authentication purposes.

A switch interconnecting clients and radius server usually acts as an authenticator and uses EAPOL (Extensible Authentication Protocol over LANs) to exchange authentication protocol messages with clients and a remote RADIUS authentication server to verify user identity and user’s access right. This section is for setting up authenticator’s configurations either on the system or on a per port basis. To configure backend server, please go to RADIUS configuration page.

4.5.3.2.1 Configuration

Network Access Server Configuration

System Configuration

Mode	Disabled
Reauthentication Enabled	<input type="checkbox"/>
Reauthentication Period	3600 seconds
EAPOL Timeout	30 seconds
Aging Period	300 seconds
Hold Time	10 seconds
RADIUS-Assigned QoS Enabled	<input type="checkbox"/>
RADIUS-Assigned VLAN Enabled	<input type="checkbox"/>
Guest VLAN Enabled	<input type="checkbox"/>
Guest VLAN ID	1
Max. Reauth. Count	2
Allow Guest VLAN if EAPOL Seen	<input type="checkbox"/>

Port Configuration

Port	Admin State	RADIUS-Assigned QoS Enabled	RADIUS-Assigned VLAN Enabled	Guest VLAN Enabled	Port State	Restart
*	<>	<input type="checkbox"/>	<input type="checkbox"/>	<input type="checkbox"/>	Globally Disabled	Reauthenticate Reinitialize
1	Force Authorized	<input type="checkbox"/>	<input type="checkbox"/>	<input type="checkbox"/>	Globally Disabled	Reauthenticate Reinitialize
2	Force Authorized	<input type="checkbox"/>	<input type="checkbox"/>	<input type="checkbox"/>	Globally Disabled	Reauthenticate Reinitialize
3	Force Authorized	<input type="checkbox"/>	<input type="checkbox"/>	<input type="checkbox"/>	Globally Disabled	Reauthenticate Reinitialize
4	Force Authorized	<input type="checkbox"/>	<input type="checkbox"/>	<input type="checkbox"/>	Globally Disabled	Reauthenticate Reinitialize
5	Force Authorized	<input type="checkbox"/>	<input type="checkbox"/>	<input type="checkbox"/>	Globally Disabled	Reauthenticate Reinitialize
6	Force Authorized	<input type="checkbox"/>	<input type="checkbox"/>	<input type="checkbox"/>	Globally Disabled	Reauthenticate Reinitialize
7	Force Authorized	<input type="checkbox"/>	<input type="checkbox"/>	<input type="checkbox"/>	Globally Disabled	Reauthenticate Reinitialize
8	Force Authorized	<input type="checkbox"/>	<input type="checkbox"/>	<input type="checkbox"/>	Globally Disabled	Reauthenticate Reinitialize
9	Force Authorized	<input type="checkbox"/>	<input type="checkbox"/>	<input type="checkbox"/>	Globally Disabled	Reauthenticate Reinitialize
10	Force Authorized	<input type="checkbox"/>	<input type="checkbox"/>	<input type="checkbox"/>	Globally Disabled	Reauthenticate Reinitialize
11	Force Authorized	<input type="checkbox"/>	<input type="checkbox"/>	<input type="checkbox"/>	Globally Disabled	Reauthenticate Reinitialize
12	Force Authorized	<input type="checkbox"/>	<input type="checkbox"/>	<input type="checkbox"/>	Globally Disabled	Reauthenticate Reinitialize
13	Force Authorized	<input type="checkbox"/>	<input type="checkbox"/>	<input type="checkbox"/>	Globally Disabled	Reauthenticate Reinitialize
14	Force Authorized	<input type="checkbox"/>	<input type="checkbox"/>	<input type="checkbox"/>	Globally Disabled	Reauthenticate Reinitialize
15	Force Authorized	<input type="checkbox"/>	<input type="checkbox"/>	<input type="checkbox"/>	Globally Disabled	Reauthenticate Reinitialize
16	Force Authorized	<input type="checkbox"/>	<input type="checkbox"/>	<input type="checkbox"/>	Globally Disabled	Reauthenticate Reinitialize
17	Force Authorized	<input type="checkbox"/>	<input type="checkbox"/>	<input type="checkbox"/>	Globally Disabled	Reauthenticate Reinitialize
18	Force Authorized	<input type="checkbox"/>	<input type="checkbox"/>	<input type="checkbox"/>	Globally Disabled	Reauthenticate Reinitialize
19	Force Authorized	<input type="checkbox"/>	<input type="checkbox"/>	<input type="checkbox"/>	Globally Disabled	Reauthenticate Reinitialize
20	Force Authorized	<input type="checkbox"/>	<input type="checkbox"/>	<input type="checkbox"/>	Globally Disabled	Reauthenticate Reinitialize

System Configuration

Mode: Enable 802.1X and MAC-based authentication globally on the switch. If globally disabled, all ports are allowed to forward frames.

Reauthentication Enabled: Select the checkbox to set clients to be re-authenticated after an interval set in "Reauthentication Period" field. Re-authentication can be used to detect if a new device is attached to a switch port.

Reauthentication Period: Specify the time interval for a connected device to be re-authenticated. By default, the re-authenticated period is set to 3600 seconds. The allowed range is 1~3600 seconds.

EAPOL Timeout: Specify the time that the switch waits for a supplicant response during an authentication session before transmitting a Request Identify EAPOL packet. By default, it is set to 30 seconds. The allowed range is 1~65535 seconds.

Aging Period: Specify the period that is used to age out a client's allowed access to the switch via 802.1X and MAC-based authentication. The default period is 300 seconds. The allowed range is 10~1000000 seconds.

Hold Time: The time after an EAP Failure indication or RADIUS timeout that a client is not allowed access. This setting applies to ports running Single 802.1X, Multi 802.1X, or MAC-based authentication. By default, hold time is set to 10 seconds. The allowed range is 10~1000000 seconds.

Radius-Assigned QoS Enabled: Select the checkbox to globally enable RADIUS assigned QoS.

Radius-Assigned VLAN Enabled: RADIUS-assigned VLAN provides a means to centrally control the VLAN on which a successfully authenticated supplicant is placed on the switch. Incoming traffic will be classified to and switched on the RADIUS-assigned VLAN. The RADIUS server must be configured to transmit special RADIUS attributes to take advantage of this feature.

The "RADIUS-Assigned VLAN Enabled" checkbox provides a quick way to globally enable/disable RADIUS-server assigned VLAN functionality. When checked, the individual ports' ditto setting determines whether RADIUS-assigned VLAN is enabled on that port. When unchecked, RADIUS-server assigned VLAN is disabled on all ports.

Guest VLAN Enabled: A Guest VLAN is a special VLAN typically with limited network access. When checked, the individual ports' ditto setting determines whether the port can be moved into Guest VLAN. When unchecked, the ability to move to the Guest VLAN is disabled on all ports.

Guest VLAN ID: This VLAN ID is functional only when Guest VLAN is enabled. This is the value that a port's Port VLAN ID is set to if a port is moved into the Guest VLAN. The range is 1~4095.

Max. Reauth. Count: The maximum number of times the switch transmits an EAPOL Request Identity frame without receiving a response before adding a port to the Guest VLAN. The value can only be changed when the Guest VLAN option is globally enabled. The range is 1~255.

Allow Guest VLAN if EAPOL Seen: The switch remembers if an EAPOL frame has been received on the port for the life-time of the port. Once the switch considers whether to enter the Guest VLAN, it will first check if this option is enabled or disabled. If disabled (unchecked; default), the switch will only enter the Guest VLAN if an EAPOL frame has not been received on the port for the life-time of the port. If enabled (checked), the switch will consider entering the Guest VLAN even if an EAPOL frame has been received on the port for the life-time of the port. The value can only be changed if the Guest VLAN option is globally enabled.

Port Configuration

Port: The port number. "Port *" rules apply to all ports.

Admin State: Select the authentication mode on a port. This setting works only when NAS is globally enabled. The following modes are available:

Force Authorized: In this mode, the switch will send one EAPOL Success frame when the port link comes up, and any client on the port will be allowed network access without authentication.

Force Unauthorized: In this mode, the switch will send one EAPOL Failure frame when the port link comes up, and any client on the port will be disallowed network access.

Port-Based 802.1X: This mode requires a dot1x-aware client to be authorized by the authentication server. Clients that are not dot1x-aware will be denied access.

Single 802.1X: In Single 802.1X, at most one supplicant can get authenticated on the port at a time. Normal EAPOL frames are used in the communication between the supplicant and the switch. If more than one supplicant is connected to a port, the one that comes first when the port's link comes up will be the first one considered. If that supplicant doesn't provide valid credentials within a certain amount of time, another supplicant will get a chance. Once a supplicant is successfully authenticated, only that supplicant will be allowed access. This is the most secure of all the supported modes. In this mode, the "Port Security" module is used to secure a supplicant's MAC address once successfully authenticated.

Multi 802.1X: In Multi 802.1X, one or more supplicants can get authenticated on the same port at the same time. Each supplicant is authenticated individually and secured in the MAC table using the "Port Security" module.

MAC-based Auth.: Unlike port-based 802.1X, MAC-based authentication do not transmit or receive EAPOL frames. In MAC-based authentication, the switch acts as the supplicant on behalf of clients. The initial frame (any kind of frame) sent by a client is snooped by the switch, which in turn uses the client's MAC address as both username and password in the subsequent EAP exchange with the RADIUS server. The 6-byte MAC address is converted to a string on the following form "xx-xx-xx-xx-xx-xx", that is, a dash (-) is used as separator between the lower-cased hexadecimal digits. The switch only supports the MD5-Challenge authentication method, so the RADIUS server must be configured accordingly.

RADIUS-Assigned QoS Enabled: Select the checkbox to enable RADIUS-Assigned QoS on a port.

Radius-Assigned VLAN Enabled: Select the checkbox to enable RADIUS-Assigned VLAN on a port.

Guest VLAN Enabled: Select the checkbox to enable Guest VLAN on a port.

Port State: Display the current state of the port from 802.1X authentication point of view. The possible states are as follows:

Globally Disabled: 802.1X and MAC-based authentication are globally disabled.

Link Down: 802.1X and MAC-based authentication are enabled but there is no link on a port.

Authorized: The port is forced in authorized mode and the supplicant is successfully authorized.

Unauthorized: The port is forced in unauthorized mode and the supplicant is not successfully authorized by the RADIUS server.

X Auth/Y Unauth: The port is in a multi-supplicant mode. X clients are authorized and Y are unauthorized.

Restart: Restart client authentication using one of the methods described below. Note that the restart buttons are only enabled when the switch's authentication mode is globally enabled (under System Configuration) and the port's Admin State is an EAPOL-based or MACBased mode. Clicking these buttons will not cause settings changed on the page to take effect.

Reauthenticate: Schedules reauthentication to whenever the quiet-period of the port runs out (EAPOL-based authentication). For MAC-based authentication, reauthentication will be attempted immediately. The button only has effect for successfully authenticated clients on the port and will not cause the clients to get temporarily unauthorized.

Reinitialize: This forces the reinitialization of the clients on the port and thereby a reauthentication immediately. The clients will transfer to the unauthorized state while the reauthentication is in progress.

4.5.3.2.2 Switch Status

Network Access Server Switch Status						
Port	Admin State	Port State	Last Source	Last ID	QoS Class	Port VLAN ID
1	Force Authorized	Globally Disabled			-	
2	Force Authorized	Globally Disabled			-	
3	Force Authorized	Globally Disabled			-	
4	Force Authorized	Globally Disabled			-	
5	Force Authorized	Globally Disabled			-	
6	Force Authorized	Globally Disabled			-	
7	Force Authorized	Globally Disabled			-	
8	Force Authorized	Globally Disabled			-	
9	Force Authorized	Globally Disabled			-	
10	Force Authorized	Globally Disabled			-	
11	Force Authorized	Globally Disabled			-	
12	Force Authorized	Globally Disabled			-	
13	Force Authorized	Globally Disabled			-	
14	Force Authorized	Globally Disabled			-	
15	Force Authorized	Globally Disabled			-	
16	Force Authorized	Globally Disabled			-	
17	Force Authorized	Globally Disabled			-	
18	Force Authorized	Globally Disabled			-	
19	Force Authorized	Globally Disabled			-	
20	Force Authorized	Globally Disabled			-	

Port: The port number. Click on a port number to view the detailed NAS statistics.

Admin State: Display the port's current administrative state.

Port Status: Display the port state.

Last Source: The source MAC address carried in the most recently received EAPOL frame for EAPOL-based authentication.

Last ID: The user name (supplicant identity) carried in the most recently received Response Identity EAPOL frame for EAPOL-based authentication.

QoS Class: Display the QoS class that NAS assigns to the port. This field is left blank if QoS is not set by NAS.

Port VLAN ID: The VLAN ID of the port assigned by NAS. This field is left blank if VLAN ID is not set by NAS.

4.5.3.2.3 Port Statistics

Receive EAPOL Counters		Transmit EAPOL Counters	
Total	0	Total	1
Response ID	0	Request ID	0
Responses	0	Requests	0
Start	0		
Logoff	0		
Invalid Type	0		
Invalid Length	0		

Port State

Admin State: Display the port's current administrative state.

Port Status: Display the port state.

Receive EAPOL Counters

Total: The number of valid EAPOL frames of any type that has been received by the switch.

Response ID: The number of valid EAPOL Response Identity frames that have been received by the switch.

Responses: The number of valid EAPOL response frames (other than Response Identity frames) that have been received by the switch.

Start: The number of EAPOL Start frames that have been received by the switch.

Logoff: The number of valid EAPOL Logoff frames that have been received by the switch.

Invalid Type: The number of EAPOL frames that have been received by the switch in which the frame type is not recognized.

Invalid Length: The number of EAPOL frames that have been received by the switch in which the Packet Body Length field is invalid.

Transmit EAPOL Counters

Total: The number of EAPOL frames of any type that has been transmitted by the switch.

Request ID: The number of valid EAPOL Request Identity frames that have been received by the switch.

Requests: The number of valid EAPOL request frames (other than Request Identity frames) that have been received by the switch.

4.5.3.3 ACL

ACL is a sequential list established to allow or deny users to access information or perform tasks on the network. In this switch, users can establish rules applied to port numbers to permit or deny actions or restrict rate limit.

4.5.3.3.1 Ports

ACL Ports Configuration									
Port	Policy ID	Action	Rate Limiter ID	Port Redirect	Mirror	Logging	Shutdown	State	Counter
*	0	∅	∅	Disabled Port 1 Port 2	∅	∅	∅	∅	*
1	0	Permit	Disabled	Disabled Port 1 Port 2	Disabled	Disabled	Disabled	Enabled	0
2	0	Permit	Disabled	Disabled Port 1 Port 2	Disabled	Disabled	Disabled	Enabled	0
3	0	Permit	Disabled	Disabled Port 1 Port 2	Disabled	Disabled	Disabled	Enabled	0
4	0	Permit	Disabled	Disabled Port 1 Port 2	Disabled	Disabled	Disabled	Enabled	0
5	0	Permit	Disabled	Disabled Port 1 Port 2	Disabled	Disabled	Disabled	Enabled	0
6	0	Permit	Disabled	Disabled Port 1 Port 2	Disabled	Disabled	Disabled	Enabled	3122
7	0	Permit	Disabled	Disabled Port 1 Port 2	Disabled	Disabled	Disabled	Enabled	0
8	0	Permit	Disabled	Disabled Port 1 Port 2	Disabled	Disabled	Disabled	Enabled	0
9	0	Permit	Disabled	Disabled Port 1 Port 2	Disabled	Disabled	Disabled	Enabled	0

Port: The port number.

Policy Id: Assign an ACL policy ID to a particular port. A port can only use one policy ID; however, a policy ID can apply to many ports. The default ID is 0. The allowed range is 0~255.

Action: Permit or deny a frame based on whether it matches a rule defined in the assigned policy.

Rate Limiter ID: Select a rate limiter ID to apply to a port. Rate Limiter rule can be set up in “Rate Limiters” configuration page.

Port Redirect: Select a port to which matching frames are redirected.

Mirror: Enable or disable mirroring feature. When enabled, a copy of matched frames will be mirrored to the destination port specified in “Mirror” configuration page. ACL-based port mirroring set by this parameter and port mirroring set on the general Mirror Configuration page are implemented independently. To use ACL-based mirroring, enable the Mirror parameter on the ACL Ports Configuration page. Then open the Mirror Configuration page, set the “Port to mirror on” field to the required destination port, and leave the “Mode” field Disabled.

Logging: Enable logging of matched frames to the system log. To view log entries, go to System menu and then click the “System Log Information” option.

Shutdown: This field is to decide whether to shut down a port when matched frames are seen or not.

State: Select a port state.

Enabled: To re-open a port.

Disabled: To close a port.

Counters: The number of frames that have matched the rules defined in the selected policy.

4.5.3.3.2 Rate Limiters

ACL Rate Limiter Configuration

Rate Limiter ID	Rate	Unit
*	1	
1	1	pps
2	1	pps
3	1	pps
4	1	pps
5	1	pps
6	1	pps
7	1	pps
8	1	pps
9	1	pps
10	1	pps
11	1	pps
12	1	pps
13	1	pps
14	1	pps
15	1	pps
16	1	pps

Save Reset

Rate Limiter ID: Display every rate limiter ID.

Rate: Specify the threshold above which packets are dropped. The allowed values are 0~3276700 pps or 1, 100, 200, 300...1000000 kbps.

Unit: Select the unit of measure used in rate.

4.5.3.3.3 Access Control List

Access Control List Configuration Auto-refresh Refresh Clear Remove All

ACE	Ingress Port	Policy / Bitmask	Frame Type	Action	Rate Limiter	Port Redirect	Mirror	Counter

Click on the to insert a new ACE entry.

You can modify each ACE (Access Control Entry) in the table using the following buttons:

- : Inserts a new ACE before the current row.
- : Edits the ACE row.
- : Moves the ACE up the list.
- : Moves the ACE down the list.
- : Deletes the ACE.

: The lowest plus sign adds a new entry at the bottom of the ACE listings.

ACE Configuration

Ingress Port: Select the ingress port of the access control entry. Select “All” to apply an ACL rule to all ports or select a particular port.

Policy Filter: Select the policy filter type. “Any” means no policy filter is assigned to this rule (or don’t care). Select “Specific” to filter specific policy with this ACE.

Frame Type: Select a frame type to match. Available frame types include Any, Ethernet, ARP, IPv4. By default, any frame type is used.

Action: Select the action type, either to permit or deny.

Rate Limiter: Enable or disable the rate limiter when matched frames are found.

Mirror: Enable or disable mirror function.

Logging: Enable or disable logging when a frame is matched.

Shutdown: Enable or disable shutdown a port when a frame is matched.

Counter: Display the number of frames that have matched any of the rules defined for this ACL.

VLAN Parameters

802.1Q Tagged: Select whether or not the frames should be tagged.

VLAN ID Filter: Select the VLAN ID filter for this ACE.

Any: No VLAN ID filter is specified. (Don’t care)

Specific: Specify a VLAN ID. A frame with the specified VLAN ID matches this ACE rule.

Tag Priority: Select the User Priority value found in the VLAN tag to match this rule.

MAC Parameter

SMAC Filter: The type of source MAC address. Select “Any” to allow all types of source MAC addresses or select “Specific” to define a source MAC address. (This field is for ARP and Ethernet frame type only.)

DMAC Filter: The type of destination MAC address.

Any: To allow all types of destination MAC addresses

MC: Multicast MAC address

BC: Broadcast MAC address

UC: Unicast MAC address

Specific: Use this to self-define a destination MAC address. (This option is for Ethernet frame type only.)

Ethernet Type Parameter

Ether Type Filter: This option can only be used to filter Ethernet II formatted packets. Select “Specific” to define an Ether Type value.

ARP Parameter

ARP/RARP: Specify the type of ARP packet.

Any: No ARP/RARP opcode flag is specified

ARP: The frame must have ARP/RARP opcode set to ARP,

RARP: The frame must have ARP/RARP opcode set to RARP

Other: The frame has unknown ARP/RARP opcode flag

Request/Reply: Specify whether the packet is an ARP request, reply, or either type.

Any: No ARP/RARP opcode flag is specified

Request: The frame must have ARP Request or RARP Request opcode flag set.

Reply: The frame must have ARP Reply or RARP Reply opcode flag set.

Sender IP Filter: Specify the sender’s IP address.

Any: No sender IP filter is specified.

Host: Specify the sender IP address.

Network: Specify the sender IP address and sender IP mask.

Target IP Filter: Specify the destination IP address.

Any: No target IP filter is specified.

Host: Specify the target IP address.

Network: Specify the target IP address and target IP mask.

ARP Sender SMAC Match: Select “0” to indicate that the SHA (Sender Hardware Address) field in the ARP/RARP frame is not equal to source MAC address. Select “1” to indicate that SHA field in the ARP/RARP frame is equal to source MAC address. Select “Any” to indicate a match and not a match.

RARP Target MAC Match: Select “0” to indicate that the THA (Target Hardware Address) field in the ARP/RARP frame is not equal to source MAC address. Select “1” to indicate that THA field in the ARP/RARP frame is equal to source MAC address. Select “Any” to indicate a match and not a match.

IP/Ethernet Length: Select “0” to indicate that HLN (Hardware Address Length) field in the ARP/RARP frame is not equal to Ethernet (0x6) and the Protocol Address Length field is not equal to IPv4 (0x4). Select “1” to indicate that HLN (Hardware Address Length) field in the ARP/RARP frame is equal to Ethernet (0x6) and the Protocol Address Length field is equal to IPv4 (0x4). Select “Any” to indicate a match and not a match.

IP: Select “0” to indicate that Protocol Address Space field in ARP/RARP frame is not equal to IP (0x800). Select “1” to indicate that Protocol Address Space is equal to IP (0x800). Select “Any” to indicate a match and not a match.

Ethernet: Select “0” to indicate that Hardware Address Space field in ARP/RARP frame is not equal to Ethernet (1). Select “1” to indicate that Hardware Address Space field is equal to Ethernet (1). Select “Any” to indicate a match and not a match.

IP Parameters

IP Protocol Filter: Select “Any”, “ICMP”, “UDP”, “TCP”, or “Other” protocol from the pull-down menu for IP Protocol filtering.

IP TTL: Select “Zero” to indicate that the TTL field in IPv4 header is 0. If the value in TTL field is not 0, use “Non-Zero” to indicate that. You can also select “any” to denote the value which is either 0 or not 0.

IP Fragment: Select “Any” to allow any values. “Yes” denotes that IPv4 frames where the MF bit is set or the FRAG OFFSET field is greater than zero must match this entry. “No” denotes that IPv4 frames where the MF bit is set or the FRAG OFFSET field is greater than zero must not match this entry.

IP Option: Specify the options flag setting for this rule. Select “Any” to allow any values. “Yes” denotes that IPv4 frames where the options flag is set must match this entry. “No” denotes that IPv4 frames where the options flag is set must not match this entry.

SIP Filter: Select “Any”, “Host”, or “Network” for source IP filtering. If “Host” is selected, you need to indicate a specific host IP address. If “Network” is selected, you need to indicate both network address and subnet mask.

SIP Address: Specify a source IP address.

SIP Mask: Specify a source subnet mask.

DIP Filter: Select “Any”, “Host”, or “Network” for destination IP filtering. If “Host” is selected, you need to indicate a specific host IP address. If “Network” is selected, you need to indicate both network address and subnet mask.

DIP Address: Specify a destination IP address.

DIP Mask: Specify a destination subnet mask.

4.5.3.3.4 ACL Status

ACL Status												
										Static	Auto-refresh <input type="checkbox"/>	Refresh
User	Ingress Port	Frame Type	Action	Rate Limiter	Port Redirect	Mirror	CPU	CPU Once	Counter	Conflict		
Static	5	Any	Permit	Disabled	Disabled	Disabled	No	No	624	No		
Static	1	Any	Permit	Disabled	Disabled	Disabled	No	No	0	No		

This page shows the ACL status by different ACL users. Each row describes the ACE that is defined. It is a conflict if a specific ACE is not applied to the hardware due to hardware limitations. The maximum number of ACEs is 256 on each switch.

User: Display the ACL user.

Ingress Port: Display the ingress port of the ACE. This field could be all ports, a specific port or a range of ports.

Frame Type: Display the frame type of the ACE. Possible values are:

Any: The ACE will match any frame type.

EType: The ACE will match Ethernet Type frames. Note that an Ethernet Type based ACE will not get matched by IP and ARP frames.

ARP: The ACE will match ARP/RARP frames.

IPv4: The ACE will match all IPv4 frames.

IPv4/ICMP: The ACE will match IPv4 frames with ICMP protocol.

IPv4/UDP: The ACE will match IPv4 frames with UDP protocol.

IPv4/TCP: The ACE will match IPv4 frames with TCP protocol.

IPv4/Other: The ACE will match IPv4 frames, which are not ICMP/UDP/TCP.

IPv6: The ACE will match all IPv6 standard frames.

Action: Display the forwarding action of the ACE.

Permit: Frames matching the ACE may be forwarded and learned.

Deny: Frames matching the ACE may be forwarded and learned.

Filtered: Frames matching the ACE are filtered.

Rate Limiter: Indicates the rate limiter number of the ACE. The allowed range is 1 to 16. When Disabled is displayed, the rate limiter operation is disabled.

Port Redirect: Indicates the port redirect operation of the ACE. Frames matching the ACE are redirected to the port number. The allowed values are Disabled or a specific port number. When Disabled is displayed, the port redirect operation is disabled.

Mirror: Specify the mirror operation of this port. The allowed values are:

Enabled: Frames received on the port are mirrored.

Disabled: Frames received on the port are not mirrored. The default value is "Disabled".

CPU: Forward packet that matched the specific ACE to CPU.

CPU Once: Forward first packet that matched the specific ACE to CPU.

Counter: The counter indicates the number of times the ACE was hit by a frame.

Conflict: Indicate the hardware status of the specific ACE. The specific ACE is not applied to the hardware due to hardware limitations.

4.5.3.4 DHCPv4

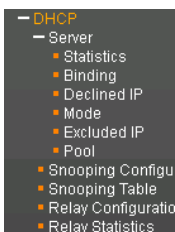

4.5.3.4.1 Server

4.5.3.4.1.1 DHCP Server Statistics

DHCP Server Statistics				
Database Counters				
Pool	Excluded IP Address	Declined IP Address		
0	0	0		
Binding Counters				
Automatic Binding	Manual Binding	Expired Binding		
0	0	0		
DHCP Message Received Counters				
DISCOVER	REQUEST	DECLINE	RELEASE	INFORM
0	0	0	0	0
DHCP Message Sent Counters				
OFFER	ACK	NAK		
0	0	0		

Database Counters

Pool: The number of pool that has been configured.

Excluded IP Address: The number of excluded IP address.

Declined IP Address: The number of declined IP address.

Binding Counters

Automatic Binding: The number of bindings with network-type pools.

Manual Binding: The number of bindings that the network engineer assigns an IP address to a client. In other words, the pool is of host type.

Expired Binding: The number of bindings that their lease time expired or they are cleared from Automatic or Manual type bindings.

DHCP Message Received Counters

Discover: The number of DHCP DISCOVER messages received.

Request: The number of DHCP REQUEST messages received.

Decline: The number of DHCP DECLINE messages received.

Release: The number of DHCP RELEASE messages received.

Inform: The number of DHCP INFORM messages received.

DHCP Message Sent Counters

OFFER: The number of DHCP OFFER messages sent.

ACK: The number of DHCP ACK messages sent.

NAK: The number of DHCP NAK messages sent.

4.5.3.4.1.2 DHCP Server Binding IP

DHCP Server Binding IP					
Auto-refresh <input type="checkbox"/> Refresh Clear Selected Clear Automatic Clear Manual Clear Expired					
Binding IP Address					
Delete	IP	Type	State	Pool Name	Server ID

IP: The IP address allocated to DHCP client.

Type: The type of binding method. This field can be “Automatic”, “Manual” or “Expired”.

State: The state of binding. Possible states are “Committed”, “Allocated”, or “Expired”.

Pool Name: The pool that generates the binding.

Server ID: The server IP address to create the binding.

4.5.3.4.1.3 DHCP Server Declined IP

DHCP Server Declined IP
Declined IP Address
Declined IP

Declined IP: Displays a list of declined IP addresses.

4.5.3.4.1.4 DHCP Server Mode Configuration

Global Mode

Mode: Enable or disable DHCP server mode. When enabled, this device can act as a DHCP server and provide IP address to clients that request for one.

VLAN Mode

Mode: Indicates the operation mode per VLAN.

Enabled: Enable DHCP server per VLAN.

Disabled: Disable DHCP server per VLAN.

NOTE: If you would like to disable DHCP server on an existing VLAN range, then follow the steps below.

1. Add one "Add VLAN Range" entry.
 2. Enter the VLAN range that you want to disable.
 3. Choose "Disabled" mode.
 4. Click "Save" to apply the change.
-

4.5.3.4.1.5 DHCP Server Excluded IP Configuration

Click "Add IP Range" to set up IP pool range.

IP Range: Enter the starting and ending IP address that are not allocated to DHCP clients. The starting IP address must be smaller or equal to the ending IP address. If there is only one excluded IP address, it can be entered either in starting or ending IP address field. The total Excluded IP address ranges can be supported is 16.

4.5.3.4.1.6 DHCP Server Pool Configuration

DHCP Server Pool Configuration

Pool Setting

Delete	Name	Type	IP	Subnet Mask	Lease Time
Delete		-	-	-	1 days 0 hours 0 minutes

Add New Pool

Save Reset

Click "Add New Pool" to add a new entry to the list. The maximum entries supported are 640.

Name: Enter the pool name for this entry. All printable characters are supported except white space. Click on the pool name after save to configure its detailed settings.

Type: Display which type the pool is. The displayed options include Network and Host. If "-" is displayed, it means this field has not been defined yet.

IP: Display network number of the DHCP address pool. If "-" is displayed, it means this field has not been defined yet.

Subnet Mask: Display subnet mask of the DHCP address pool. If "-" is displayed, it means this field has not been defined yet.

Lease Time: Display the lease time of the configured pool.

Click on the pool name to configure its detailed settings.

DHCP Pool Configuration

Pool

Name: 123

Setting

Pool Name	123
Type	None
IP	0.0.0.0
Subnet Mask	0.0.0.0
Lease Time	1 days (0-365) 0 hours (0-23) 0 minutes (0-59)
Domain Name	
Broadcast Address	0.0.0.0
Allocate reserved entries only	Off
Default Router	0.0.0.0 0.0.0.0 0.0.0.0 0.0.0.0
DNS Server	0.0.0.0 0.0.0.0 0.0.0.0 0.0.0.0

Reserved Ip Addresses

Delete	Reserved address	Interface
No entry exists		

Add New Entry

Save

Pool

Name: Select the pool name that you want to configure from the pull-down menu.

Setting

Pool Name: Display the pool name for this configured entry.

Type: Select the pool type.

Network: The pool defines a pool of IP addresses to service more than one DHCP client.

Host: The pool services for a specific DHCP client identified by client identifier or hardware address.

IP: Specify the network IP of the DHCP address pool.

Subnet Mask: Specify subnet mask of the DHCP address pool.

Lease Time: Specify lease time that a client needs to send requests to the DHCP server for renewed IP address. If all are 0's, then it means the lease time is infinite.

Domain Name: Specify the domain name that a client use when resolving hostname via DNS.

Broadcast Address: Specify the broadcast address in use on the client's subnet.

Default Router: Specify a list of IP addresses for routers on the clients' subnet.

DNS Server: Specify a list of Domain Name System name servers available to the client.

NTP Server: Specify a list of IP addresses indicating NTP servers available to the client.

NetBios Node Type: Select NetBIOS node type option to allow Netbios over TCP/IP clients which are configurable to be configured as described in RFC 1001/1002.

NetBIOS Scope: Specify the NetBIOS over TCP/IP scope parameter for the client as specified in RFC 1001/1002.

NetBIOS Name Server: Specify a list of NBNS name servers listed in order of preference.

NIS Domain Name: Specify the name of the client's NIS domain.

NIS Server: Specify a list of IP addresses indicating NIS servers available to the client.

Client Identifier: Specify client's unique identifier to be used when the pool is the type of host.

Hardware Address: Specify client's hardware (MAC) address to be used when the pool is the type of host.

Client Name: Specify the name of client to be used when the pool is the type of host.

Vendor 1~4 Class Identifier: Specify to be used by DHCP client to optionally identify the vendor type and configuration of a DHCP client. DHCP server will deliver the corresponding option 43 specific information to the client that sends option 60 vendor class identifier.

Vendor 1~4 Specific Information: Specify vendor specific information according to option 60 vendor class identifier.

Reserved IP Address

Click the "Add New Entry" button to create a new rule.

Reserved Address: Specify the IP addresses reserved for the port interface.

Interface: Specify the interface that uses the reserved IP address.

4.5.3.4.2 Snooping Configuration

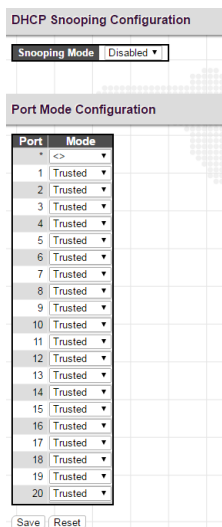

DHCP Snooping Configuration

Snooping Mode: Enable or disable DHCP Snooping function globally. When DHCP snooping mode operation is enabled, the DHCP request messages will be forwarded to trusted ports and only allow reply packets from trusted ports.

Port Mode Configuration

Port: Port number. "Port *" rules apply to all ports.

Mode: Select the DCHP Snooping port mode. Ports can be set to either “Trusted” or “Untrusted”.

4.5.3.4.3 Snooping Table

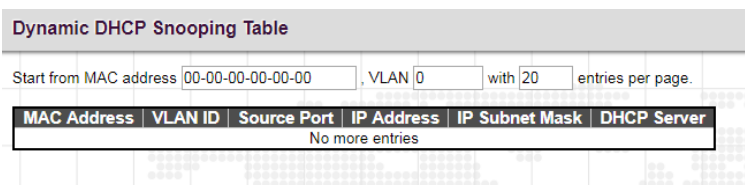

This page displays the dynamic IP assigned information after DHCP Snooping mode is disabled. All DHCP clients obtained the dynamic IP address from the DHCP server will be listed in this table except for local VLAN interface IP addresses. Entries in the Dynamic DHCP snooping Table are shown on this page.

Each page shows up to 99 entries from the Dynamic DHCP snooping table, default being 20, selected through the "entries per page" input field. When first visited, the web page will show the first 20 entries from the beginning of the Dynamic DHCP snooping Table.

The "MAC address" and "VLAN" input fields allows the user to select the starting point in the Dynamic DHCP snooping Table. Clicking the button will update the displayed table starting from that or the closest next Dynamic DHCP snooping Table match. In addition, the two input fields will - upon a button click - assume the value of the first displayed entry, allowing for continuous refresh with the same start address.

The system will use the last entry of the currently displayed table as a basis for the next lookup. When the end is reached the text "No more entries" is shown in the displayed table. Use the button to start over.

MAC Address: User MAC address of the entry.

VLAN ID: VLAN-ID in which the DHCP traffic is permitted.

Source Port: Switch Port Number for which the entries are displayed.

IP Address: User IP address of the entry.

IP Subnet Mask: User IP subnet mask of the entry.

DHCP Server Address: DHCP Server address of the entry.

4.5.3.4.4 DHCP Relay Configuration

DHCP Relay Configuration	
Relay Mode	Disabled
Relay Server	0.0.0.0
Relay Information Mode	Disabled
Relay Information Policy	Keep

Save Reset

Relay Mode: Enable or disable the DHCP relay function.

Relay Server: Enter DHCP server IP address that is used by the switch's DHCP relay agent.

Relay Information Mode: Enable or disable DHCP Relay option 82 function. Please note that "Relay Mode" must be enabled before this function is able to take effect.

Relay Information Policy: Select Relay Information policy for DHCP client that includes option 82 information.

Replace: Replace the DHCP client packet information with the switch's relay information. This is the default setting.

Keep: Keep the client's DHCP information.

Drop: Drop the packet when it receives a DHCP message that already contains relay information.

4.5.3.4.5 Relay Statistics

DHCP Relay Statistics								Auto-refresh <input type="checkbox"/>	Refresh	Clear
Server Statistics										
Transmit to Server	Transmit Error	Receive from Server	Receive Missing Agent Option	Receive Missing Circuit ID	Receive Missing Remote ID	Receive Bad Circuit ID	Receive Bad Remote ID			
0	0	0	0	0	0	0	0			
Client Statistics										
Transmit to Client	Transmit Error	Receive from Client	Receive Agent Option	Replace Agent Option	Keep Agent Option	Drop Agent Option				
0	0	0	0	0	0	0				

DHCP Relay Statistics

Transmit to Server: The number of packets that are relayed from client to server.

Transmit Error: The number of packets that resulted in errors while being sent to clients.

Receive from Client: The number of packets received from server.

Receive Missing Agent Option: The number of packets received without agent information options.

Receive Missing Circuit ID: The number of packets received with the Circuit ID option missing.

Receive Missing Remote ID: The number of packets received with the Remote ID option missing.

Receive Bad Circuit ID: The number of packets whose Circuit ID option did not match known circuit ID.

Receive Bad Remote ID: The number of packets whose Remote ID option did not match known Remote ID.

Client Statistics

Transmit to Client: The number of relayed packets from server to client.

Transmit Error: The number of packets that resulted in error while being sent to servers.

Receive from Client: The number of received packets from server.

Receive Agent Option: The number of received packets with relay agent information option.

Replace Agent Option: The number of packets which were replaced with relay agent information option.

Keep Agent Option: The number of packets whose relay agent information was retained.

Drop Agent Option: The number of packets that were dropped which were received with relay agent information.

4.5.3.4.6 Detailed Statistics

DHCP Detailed Statistics Port 1			
Receive Packets		Transmit Packets	
Rx Discover	0	Tx Discover	0
Rx Offer	0	Tx Offer	0
Rx Request	0	Tx Request	0
Rx Decline	0	Tx Decline	0
Rx ACK	0	Tx ACK	0
Rx NAK	0	Tx NAK	0
Rx Release	0	Tx Release	0
Rx Inform	0	Tx Inform	0
Rx Lease Query	0	Tx Lease Query	0
Rx Lease Unassigned	0	Tx Lease Unassigned	0
Rx Lease Unknown	0	Tx Lease Unknown	0
Rx Lease Active	0	Tx Lease Active	0
Rx Discarded Checksum Error	0		
Rx Discarded from Untrusted	0		

Rx and Tx Discover: The number of discover (option 53 with value 1) packets received and transmitted.

Rx and Tx Offer: The number of offer (option 53 with value 2) packets received and transmitted.

Rx and Tx Request: The number of request (option 53 with value 3) packets received and transmitted.

Rx and Tx Decline: The number of decline (option 53 with value 4) packets received and transmitted.

Rx and Tx ACK: The number of ACK (option 53 with value 5) packets received and transmitted.

Rx and Tx NAK: The number of NAK (option 53 with value 6) packets received and transmitted.

Rx and Tx Release: The number of release (option 53 with value 7) packets received and transmitted.

Rx and Tx Inform: The number of inform (option 53 with value 8) packets received and transmitted.

Rx and Tx Lease Query: The number of lease query (option 53 with value 10) packets received and transmitted.

Rx and Tx Lease Unassigned: The number of lease unassigned (option 53 with value 11) packets received and transmitted.

Rx and Tx Lease Unknown: The number of lease unknown (option 53 with value 12) packets received and transmitted.

Rx and Tx Lease Active: The number of lease active (option 53 with value 13) packets received and transmitted.

Rx Discarded checksum error: The number of discard packet that IP/UDP checksum is error.

Rx Discarded from Untrusted:The number of discarded packet that are coming from untrusted port.

4.5.3.5 DHCPv6

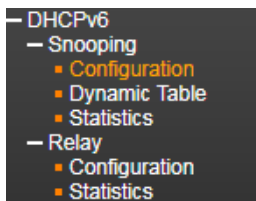

4.5.3.5.1 Snooping Configurations

DHCPv6 Snooping Configuration

Switch Configuration

Snooping Mode	Disabled ▾
Unknown IPv6 Next-Headers	Drop ▾

Port Configuration

Port	Trust Mode
*	<> ▾
1	Untrusted ▾
2	Untrusted ▾
3	Untrusted ▾
4	Untrusted ▾
5	Untrusted ▾
6	Untrusted ▾
7	Untrusted ▾
8	Untrusted ▾
9	Untrusted ▾
10	Untrusted ▾
11	Untrusted ▾
12	Untrusted ▾

Switch Configuration

Snooping Mode: Enable or disable IPv6 DHCP Snooping mode. When DHCPv6 snooping mode operation is enabled, the DHCPv6 client request messages will be forwarded to trusted ports and only allow reply packets from trusted ports.

Unknown IPv6 Next Headers: Specify how unknown IPv6 "next-header" values should be treated. The switch needs to parse all IPv6 packets to a DHCPv6 client to determine if it is in fact a DHCPv6 message. If an unknown IPv6 extension header is encountered the parsing cannot continue. See RFC 7610, section 5, item 3 for details.

Drop: Drop packets with unknown IPv6 extension headers. This is the most secure option but may result in traffic disruptions.

Allow: Allow packets with unknown IPv6 extension headers. This is a less secure option but prevents traffic disruptions.

Port Configuration

Trust Mode: Select DHCPv6 snooping mode.

Trusted: Configure the port as trusted source of the DHCPv6 messages.

Untrusted: Configure the port as untrusted source of the DHCPv6 messages.

4.5.3.5.2 Dynamic (Snooping) Table

DHCPv6 Snooping Table							
This table display the currently known DHCPv6 clients and their assigned addresses.							
Total entries: 0							
Client DUID	MAC Address	Ingress Port	IAID	VLAN ID	Assigned Address	Lease Time	DHCP Server Address

DUID: The DHCP Unique Identifier (DUID) for the client. DHCPv6 uses this value to uniquely identify a client host instead of just using the MAC address of one of its interface ports (as DHCPv4 does).

MAC Address: The MAC address for the client interface port that sent the DHCPv6 message.

Ingress Port: The local port on the snooping switch where client messages are received.

IAID: Each client may contain multiple interfaces and may request addresses for each of these in the same DHCPv6 message. The Identity Association ID (IAID) value uniquely identifies the interface in the scope of the client.

VLAN ID: The VLAN ID which is used by the client messages.

Assigned Address: The address assigned to the interface identified by the IAID value.

Lease Time: The lease time associated with the assigned address in seconds.

DHCP Server Address: The IPv6 address of the DHCP server which assigned the address to the client.

4.5.3.5.3 Statistics

DHCPv6 Snooping Statistics			
Receive Packets		Transmit Packets	
Rx Solicit	0	Tx Solicit	0
Rx Request	0	Tx Request	0
Rx InfoRequest	0	Tx InfoRequest	0
Rx Confirm	0	Tx Confirm	0
Rx Renew	0	Tx Renew	0
Rx Rebind	0	Tx Rebind	0
Rx Decline	0	Tx Decline	0
Rx Advertise	0	Tx Advertise	0
Rx Reply	0	Tx Reply	0
Rx Reconfigure	0	Tx Reconfigure	0
Rx Release	0	Tx Release	0
Rx DiscardUntrust	0		

This page provides statistics for DHCPv6 snooping.

General Receive and Transmit Packets

The page contains both RX and TX counters for all known DHCPv6 message types.

Please refer to RFC 3315 for details on the various DHCPv6 message types.

4.5.3.5.4 Relay Configuration

Interface: Interface identification.

Relay Interface: Specify the interface used for relaying.

Relay Destination: Specify the IPv6 address of the DHCPv6 server that requests shall be relayed to.

4.5.3.5.5 Status & Statistics

Interface: Interface identification. The ID of the interface that receives client requests.

Relay Interface: Interface identification. The ID of the interface used for relaying.

Relay Address: An IPv6 address represented as human readable text as specified in RFC5952. The IPv6 address that requests shall be relayed to. The default value 'ff05::1:3' means 'any DHCPv6 server'.

Tx to server: Integer number. Number of packets relayed to server.

Rx from server: Integer number. Number of packets received from server.

Server pkts dropped: Integer number. Number of packets from server that relay agent drops.

Tx to client: Integer number. Number of packets sent to client.

Rx from client: Integer number. Number of packets received from client.

Client pkts dropped: Integer number. Number of packets from client that relay agent drops.

Clear all statistics: Resets all statistics counters of relevant entry to zero.

4.5.3.6 IP Source Guard

4.5.3.6.1 Configuration

The screenshot shows two configuration sections. The first section, 'IP Source Guard Configuration', has a 'Mode' dropdown set to 'Disabled' and a 'Translate dynamic to static' button. The second section, 'Port Mode Configuration', contains a table with 21 rows. The first row is for the global configuration (Port *), and the following 20 rows are for individual ports (1-20). Each row has three columns: 'Port', 'Mode', and 'Max Dynamic Clients'. All 'Mode' values are 'Disabled' and all 'Max Dynamic Clients' values are 'Unlimited'. At the bottom of the table are 'Save' and 'Reset' buttons.

Port	Mode	Max Dynamic Clients
*	<>	<>
1	Disabled	Unlimited
2	Disabled	Unlimited
3	Disabled	Unlimited
4	Disabled	Unlimited
5	Disabled	Unlimited
6	Disabled	Unlimited
7	Disabled	Unlimited
8	Disabled	Unlimited
9	Disabled	Unlimited
10	Disabled	Unlimited
11	Disabled	Unlimited
12	Disabled	Unlimited
13	Disabled	Unlimited
14	Disabled	Unlimited
15	Disabled	Unlimited
16	Disabled	Unlimited
17	Disabled	Unlimited
18	Disabled	Unlimited
19	Disabled	Unlimited
20	Disabled	Unlimited

IP Source Guard Configuration

Mode: Enable or disable IP source guard globally.

Translate dynamic to static: Click this button to translate dynamic entries to static ones.

Port Mode Configuration

Port: The port number. "Port *" rules apply to all ports.

Mode: Enable or disable IP source guard on a port. Please note that to make IP source guard work, both global mode and port mode must be enabled.

Max Dynamic Clients: Select the maximum number of dynamic clients that can be learned on a port. The available options are 0, 1, 2, unlimited. If the port mode is enabled and the maximum number of dynamic clients is equal 0, the switch will only forward IP packets that are matched in static entries for a given port.

4.5.3.6.2 Static Table

Delete	Port	VLAN ID	IP Address	MAC address
<input type="checkbox"/>	1			

Port: Select a port to which a static entry is bound.

VLAN ID: Enter VLAN ID that has been configured.

IP Address: Enter a valid IP address.

MAC Address: Enter a valid MAC address.

Click the “Add New Entry” button to insert an entry to the table.

Select the “Delete” checkbox to remove the entry during the next save.

Click the “Save” button to save settings or changes.

Click the “Reset” button to restore settings to default settings or previously configured settings.

4.5.3.6.3 Dynamic Table

The Dynamic IP Source Guard table shows entries sorted by port, VLAN ID, IP address and MAC address. By default, each page displays 20 entries. However, it can display 999 entries by entering the number in “entries per page” input field.

Dynamic IP Source Guard Table Auto-refresh Refresh << >>

Start from Port 1, VLAN 1 and IP address 0.0.0.0 with 20 entries per page.

Port	VLAN ID	IP Address	MAC Address
No more entries			

4.5.3.7 IPv6 Source Guard

4.5.3.7.1 Source Guard Configuration

IPv6 Source Guard Configuration

Mode: Disabled

Translate dynamic to static

Port	Mode	Max Dynamic Clients
*	<>	<>
1	Disabled	Unlimited
2	Disabled	Unlimited
3	Disabled	Unlimited
4	Disabled	Unlimited
5	Disabled	Unlimited
6	Disabled	Unlimited
7	Disabled	Unlimited
8	Disabled	Unlimited
9	Disabled	Unlimited
10	Disabled	Unlimited
11	Disabled	Unlimited
12	Disabled	Unlimited
13	Disabled	Unlimited
14	Disabled	Unlimited
15	Disabled	Unlimited
16	Disabled	Unlimited
17	Disabled	Unlimited
18	Disabled	Unlimited
19	Disabled	Unlimited
20	Disabled	Unlimited

Save

IPv6 Source Guard Configuration

Mode: Enable or disable IPv6 source guard globally.

Translate dynamic to static: Click this button to translate dynamic entries to static ones.

Port Mode Configuration

Port: The port number. "Port *" rules apply to all ports.

Mode: Enable or disable IPv6 source guard on a port. Please note that to make IPv6 source guard work, both global mode and port mode must be enabled.

Max Dynamic Clients: Select the maximum number of dynamic clients that can be learned on a port. The available options are 0, 1, 2, unlimited. If the port mode is enabled and the maximum number of dynamic clients is equal 0, the switch will only forward IPv6 packets that are matched in static entries for a given port.

4.5.3.7.2 Static Table

This page shows the static IPv6 Source Guard entries. The maximum number of entries is 112 on the switch.

Port: Select a port to which a static entry is bound.

VLAN ID: Enter VLAN ID that has been configured.

IP Address: Enter a valid IPv6 address.

MAC Address: Enter a valid MAC address.

Click the **Add Entry** button to insert an entry to the IPv6 Source Guard static table.

Select the **Delete** checkbox to remove the entry during the next save.

Click the **Save** button to save settings or changes.

Click the **Reset** button to restore settings to default settings or previously configured settings.

4.5.3.7.3 Dynamic Table

Port: The port number to which the entries are bound.

VLAN ID: Shows VLAN ID in which the IPv6 traffic is permitted. If no VLAN-ID is associated with the entry, this field shows 0.

IPv6 Address: Shows Source IPv6 address of the entry.

MAC Address: Shows source MAC address.

4.5.3.8 ARP Inspection

4.5.3.8.1 Port Configuration

ARP Inspection Configuration

Mode: Disabled ▾

Translate dynamic to static

Port Mode Configuration

Port	Mode	Check VLAN	Log Type
*	<> ▾	<> ▾	<> ▾
1	Disabled ▾	Disabled ▾	None ▾
2	Disabled ▾	Disabled ▾	None ▾
3	Disabled ▾	Disabled ▾	None ▾
4	Disabled ▾	Disabled ▾	None ▾
5	Disabled ▾	Disabled ▾	None ▾
6	Disabled ▾	Disabled ▾	None ▾
7	Disabled ▾	Disabled ▾	None ▾
8	Disabled ▾	Disabled ▾	None ▾
9	Disabled ▾	Disabled ▾	None ▾
10	Disabled ▾	Disabled ▾	None ▾
11	Disabled ▾	Disabled ▾	None ▾
12	Disabled ▾	Disabled ▾	None ▾
13	Disabled ▾	Disabled ▾	None ▾
14	Disabled ▾	Disabled ▾	None ▾
15	Disabled ▾	Disabled ▾	None ▾
16	Disabled ▾	Disabled ▾	None ▾
17	Disabled ▾	Disabled ▾	None ▾
18	Disabled ▾	Disabled ▾	None ▾
19	Disabled ▾	Disabled ▾	None ▾
20	Disabled ▾	Disabled ▾	None ▾

ARP Inspection Configuration

Mode: Enable or disable ARP inspection function globally.

Port Mode Configuration

Port: The port number. "Port *" rules apply to all ports.

Mode: Enable or disable ARP Inspection on a port. Please note that to make ARP inspection work, both global mode and port mode must be enabled.

Check VLAN: Enable or disable check VLAN operation.

Log Type: There are four log types available.

None: Log nothing.

Deny: Log denied entries.

Permit: Log permitted entries.

All: Log all entries.

4.5.3.8.2 VLAN Configuration

VLAN ID: Specify ARP Inspection is enabled on which VLANs. First, you have to enable the port setting on Port mode configuration web page. Only when both Global Mode and Port Mode on a given port are enabled, ARP Inspection is enabled on this given port. Second, you can specify which VLAN will be inspected on VLAN mode configuration web page. The log type also can be configured on per VLAN setting.

Log Type: There are four log types available.

None: Log nothing.

Deny: Log denied entries.

Permit: Log permitted entries.

All: Log all entries.

Click the **Add New Entry** button to insert an entry to the table.

Select the **Delete** checkbox to remove the entry during the next save.

Click the **Save** button to save newly-configured settings or changes.

Click the **Reset** button to restore settings to default settings or previously configured settings.

4.5.3.8.3 Static Table

Port: Select a port to which a static entry is bound.

VLAN ID: Specify a configured VLAN ID.

MAC Address: Specify an allowed source MAC address in ARP request packets.

IP Address: Specify an allowed source IP address in ARP request packets.

Click the **Add New Entry** button to insert an entry to the table.

Select the **Delete** checkbox to remove the entry during the next save.

Click the **Save** button to save newly-configured settings or changes.

Click the **Reset** button to restore settings to default settings or previously configured settings.

4.5.3.8.4 Dynamic Table Configuration

Port: The port number of this entry.

VLAN ID: VLAN ID in which the ARP traffic is permitted.

MAC Address: User MAC address of this entry.

IP Address: User IP address of this entry.

Translate to static: Click the button to translate the dynamic entry to static one.

4.5.3.8.5 Dynamic Table Status

Port: The port number of this entry.

VLAN ID: VLAN ID in which the ARP traffic is permitted.

MAC Address: User MAC address of this entry.

4.5.4 AAA

4.5.4.1 Radius Server Configuration

RADIUS Server Configuration

Global Configuration

Timeout	5	seconds
Retransmit	3	times
Deadtime	0	minutes
Key		
NAS-IP-Address		
NAS-IPv6-Address		
NAS-Identifier		

Server Configuration

Delete	Hostname	Auth Port	Acct Port	Timeout	Retransmit	Key
Add New Server						
Save Reset						

Global Configuration

Timeout: The time the switch waits for a reply from an authentication server before it retransmits the request.

Retransmit: Specify the number of times to retransmit request packets to an authentication server that does not respond. If the server does not respond after the last retransmit is sent, the switch considers the authentication server is dead.

Deadtime: Deadtime is the period during which the switch will not send new requests to a server that has failed to respond to a previous request. This will stop the switch from continually trying to contact a server that it has already determined as dead. Setting the Deadtime to a value greater than 0 (zero) will enable this feature, but only if more than one server has been configured. The allowed deadtime range is between 0 to 1440minutes.

Key: Specify the secret key up to 64 characters. This is shared between the RADIUS sever and the switch.

NAS-IP-Address: The IPv4 address is used as attribute 4 in RADIUS Access-Request packets. If this field is left blank, the IP address of the outgoing interface is used.

NAS-IPv6-Address: The IPv6 address is used as attribute 95 in RADIUS Access-Request packets. If this field is left blank, the IP address of the outgoing interface is used.

NAS Identifier: The identifier, up to 256 characters long, is used as attribute 32 in RADIUS Access-Request packets. If this field is left blank, the NAS-Identifier is not included in the packet.

Sever Configuration

Hostname: The hostname or IP address for the RADIUS server.

Auth Port: The UDP port to be used on the RADIUS server for authentication.

Acct Port: The UDP port to be used on the RADIUS server for accounting.

Timeout: If timeout value is specified here, it will replace the global timeout value. If you prefer to use the global value, leave this field blank.

Retransmit: If retransmit value is specified here, it will replace the global retransmit value. If you prefer to use the global value, leave this field blank.

Key: If secret key is specified here, it will replace the global secret key. If you prefer to use the global value, leave this field blank.

4.5.4.2 RADIUS Overview

RADIUS Server Status Overview					
#	IP Address	Authentication Port	Authentication Status	Accounting Port	Accounting Status
1			Disabled		Disabled
2			Disabled		Disabled
3			Disabled		Disabled
4			Disabled		Disabled
5			Disabled		Disabled

RADIUS Server Status Overview

IP Address: The configured IP address of this server.

Authentication Port: UDP port number for authentication.

Authentication Status: The current state of RADIUS authentication server. Displayed states include the following:

Disabled: This server is disabled.

Not Ready: The server is ready but IP communication is not yet up and running.

Ready: The server is ready and IP communication is not yet up and running. The RADIUS server is ready to accept access attempts.

Dead (X seconds left): Access attempts were made to this server, but it did not reply within the configured timeout. The server has temporarily been disabled, but will get re-enabled when the dead-time expires. The number of seconds left before this occurs is displayed in parentheses. This state is only reachable when more than one server is enabled.

Accounting Port: UDP port number for accounting.

Accounting Status: The current status of the server. This field takes one of the following values:

Disabled: The server is disabled.

Not Ready: The server is enabled, but IP communication is not yet up and running.

Ready: The server is enabled, IP communication is up and running, and the RADIUS module is ready to accept access attempts.

Dead (X seconds left): Access attempts were made to this server, but it did not reply within the configured timeout. The server has temporarily been disabled, but will get re-enabled when the dead-time expires. The number of seconds left before this occurs is displayed in parentheses. This state is only reachable when more than one server is enabled.

4.5.4.3 RADIUS Details

RADIUS Authentication Statistics for Server #1			
		Server #1	Auto-refresh <input type="checkbox"/>
		Refresh	Clear
Receive Packets		Transmit Packets	
Access Accepts	0	Access Requests	0
Access Rejects	0	Access Retransmissions	0
Access Challenges	0	Pending Requests	0
Malformed Access Responses	0	Timeouts	0
Bad Authenticators	0		
Unknown Types	0		
Packets Dropped	0		
Other Info			
IP Address		0.0.0.0:0	
State		Disabled	
Round-Trip Time		0 ms	
RADIUS Accounting Statistics for Server #1			
Receive Packets		Transmit Packets	
Responses	0	Requests	0
Malformed Responses	0	Retransmissions	0
Bad Authenticators	0	Pending Requests	0
Unknown Types	0	Timeouts	0
Packets Dropped	0		
Other Info			
IP Address		0.0.0.0:0	
State		Disabled	
Round-Trip Time		0 ms	

RADIUS Authentication Statistics for Server

Access Accepts: The number of RADIUS Access-Accept packets (valid or invalid) received from the server.

Access Rejects: The number of RADIUS Access-Reject packets (valid or invalid) received from the server.

Access Challenges: The number of RADIUS Access-Challenge packets (valid or invalid) received from the server.

Malformed Access Responses: The number of malformed RADIUS Access-Response packets received from the server. Malformed packets include packets with an invalid length. Bad authenticators or Message Authenticator attributes or unknown types are not included as malformed access responses.

Bad Authenticators: The number of RADIUS Access-Response packets containing invalid authenticators or Message Authenticator attributes received from the server.

Unknown Types: The number of RADIUS packets that were received with unknown types from the server on the authentication port and dropped.

Packets Dropped: The number of RADIUS packets that were received from the server on the authentication port and dropped for some other reason.

Access Requests: The number of RADIUS Access-Request packets sent to the server. This does not include retransmissions.

Access Retransmissions: The number of RADIUS Access-Request packets retransmitted to the RADIUS authentication server.

Pending Requests: The number of RADIUS Access-Request packets destined for the server that have not yet timed out or received a response. This variable is incremented when an Access-Request is sent and decremented due to receipt of an Access-Accept, Access-Reject, Access-Challenge, timeout, or retransmission.

Timeouts: The number of authentication timeouts to the server. After a timeout, the client may retry to the same server, send to a different server, or give up. A retry to the same server is counted as a retransmit as well as a timeout. A send to a different server is counted as a Request as well as a timeout.

IP Address: IP address and UDP port for the authentication server in question.

State: Shows the state of the server. It takes one of the following values:

Disabled: The selected server is disabled.

Not Ready: The server is enabled, but IP communication is not yet up and running.

Ready: The server is enabled, IP communication is up and running, and the RADIUS module is ready to accept access attempts.

Dead (X seconds left): Access attempts were made to this server, but it did not reply within the configured timeout. The server has temporarily been disabled, but will get re-enabled when the dead-time expires. The number of seconds left before this occurs is displayed in parentheses. This state is only reachable when more than one server is enabled.

Round-Trip Time: The time interval (measured in milliseconds) between the most recent Access-Reply/Access-Challenge and the Access-Request that matched it from the RADIUS authentication server. The granularity of this measurement is 100 ms. A value of 0 ms indicates that there hasn't been round-trip communication with the server yet.

RADIUS Accounting Statistics for Server

Responses: The number of RADIUS packets (valid or invalid) received from the server.

Malformed Responses: The number of malformed RADIUS packets received from the server. Malformed packets include packets with an invalid length. Bad authenticators or unknown types are not included as malformed access responses.

Bad Authenticators: The number of RADIUS packets containing invalid authenticators received from the server.

Unknown Types: The number of RADIUS packets of unknown types that were received from the server on the accounting port.

Packets Dropped: The number of RADIUS packets that were received from the server on the accounting port and dropped for some other reason.

Requests: The number of RADIUS packets sent to the server. This does not include retransmissions.

Retransmissions: The number of RADIUS packets retransmitted to the RADIUS accounting server.

Pending Requests: The number of RADIUS packets destined for the server that have not yet timed out or received a response. This variable is incremented when a Request is sent and decremented due to receipt of a Response, timeout, or retransmission.

Timeouts: The number of accounting timeouts to the server. After a timeout, the client may retry to the same server, send to a different server, or give up. A retry to the same server is counted as a retransmit as well as a timeout. A send to a different server is counted as a Request as well as a timeout.

IP Address: IP address and UDP port for the accounting server in question.

State: Shows the state of the server. It takes one of the following values:

Disabled: The selected server is disabled.

Not Ready: The server is enabled, but IP communication is not yet up and running.

Ready: The server is enabled, IP communication is up and running, and the RADIUS module is ready to accept accounting attempts.

Dead (X seconds left): Accounting attempts were made to this server, but it did not reply within the configured timeout. The server has temporarily been disabled, but will get re-enabled when the dead-time expires. The number of seconds left before this occurs is displayed in parentheses. This state is only reachable when more than one server is enabled.

Round-Trip Time: The time interval (measured in milliseconds) between the most recent Response and the Request that matched it from the RADIUS accounting server. The granularity of this measurement is 100 ms. A value of 0 ms indicates that there hasn't been round-trip communication with the server yet.

4.5.4.4 TACACS+

TACACS+ Server Configuration

Global Configuration

Timeout	5	seconds
Deadtime	0	minutes
Key		

Server Configuration

Delete	Hostname	Port	Timeout	Key
Delete		49		

Add New Server

Save Reset

Global Configuration

Timeout: The time the switch waits for a reply from a TACACS+ server before it retransmits the request.

Deadtime: Deadtime is the period during which the switch will not send new requests to a server that has failed to respond to a previous request. This will stop the switch from continually trying to contact a server that it has already determined as dead. Setting the Deadtime to a value greater than 0 (zero) will enable this feature, but only if more than one server has been configured. The allowed deadtime range is between 0 to 1440 minutes.

Key: Specify the secret key up to 63 characters. This is shared between a TACACS+ sever and the switch.

Server Configuration

Hostname: The hostname or IP address for a TACACS+ server.

Port: The TCP port number to be used on a TACACS+ server for authentication.

Timeout: If timeout value is specified here, it will replace the global timeout value. If you prefer to use the global value, leave this field blank.

Key: If secret key is specified here, it will replace the global secret key. If you prefer to use the global value, leave this field blank.

4.6 Aggregation

Compared with adding cost to install extra cables to increase the redundancy and link speed, link aggregation is a relatively inexpensive way to set up a high-speed backbone network that transfers much more data than any one single port or device can deliver. Link aggregation uses multiple ports in parallel to increase the link speed. And there are two types of aggregation that are available, namely “Static” and “LACP”.

Under the Aggregation heading are two major icons, static and LACP.

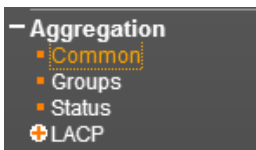

4.6.1 Common

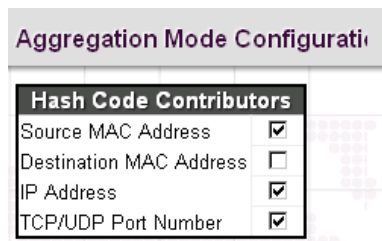

Aggregation Mode Configuration

Source MAC Address: All traffic from the same Source MAC address is output on the same link in a trunk.

Destination MAC Address: All traffic with the same Destination MAC address is output on the same link in a trunk.

IP Address: All traffic with the same source and destination IP address is output on the same link in a trunk.

TCP/UDP Port Number: All traffic with the same source and destination TCP/UDP port number is output on the same link in a trunk.

4.6.2 Groups

Aggregation Group Configuration																							
Group ID	Port Members																				Group Configuration		
	1	2	3	4	5	6	7	8	9	10	11	12	13	14	15	16	17	18	19	20	Mode	Revertive	Max Bundle
Normal	<input checked="" type="checkbox"/>	<input checked="" type="checkbox"/>	<input checked="" type="checkbox"/>	<input checked="" type="checkbox"/>	<input checked="" type="checkbox"/>	<input checked="" type="checkbox"/>	<input checked="" type="checkbox"/>	<input checked="" type="checkbox"/>	<input checked="" type="checkbox"/>	<input checked="" type="checkbox"/>	<input checked="" type="checkbox"/>	<input checked="" type="checkbox"/>	<input checked="" type="checkbox"/>	<input checked="" type="checkbox"/>	<input checked="" type="checkbox"/>	<input checked="" type="checkbox"/>	<input checked="" type="checkbox"/>	<input checked="" type="checkbox"/>	<input checked="" type="checkbox"/>	<input checked="" type="checkbox"/>	Disabled	<input checked="" type="checkbox"/>	20
1	<input type="checkbox"/>	<input type="checkbox"/>	<input type="checkbox"/>	<input type="checkbox"/>	<input type="checkbox"/>	<input type="checkbox"/>	<input type="checkbox"/>	<input type="checkbox"/>	<input type="checkbox"/>	<input type="checkbox"/>	<input type="checkbox"/>	<input type="checkbox"/>	<input type="checkbox"/>	<input type="checkbox"/>	<input type="checkbox"/>	<input type="checkbox"/>	<input type="checkbox"/>	<input type="checkbox"/>	<input type="checkbox"/>	<input type="checkbox"/>	Disabled	<input checked="" type="checkbox"/>	20
2	<input type="checkbox"/>	<input type="checkbox"/>	<input type="checkbox"/>	<input type="checkbox"/>	<input type="checkbox"/>	<input type="checkbox"/>	<input type="checkbox"/>	<input type="checkbox"/>	<input type="checkbox"/>	<input type="checkbox"/>	<input type="checkbox"/>	<input type="checkbox"/>	<input type="checkbox"/>	<input type="checkbox"/>	<input type="checkbox"/>	<input type="checkbox"/>	<input type="checkbox"/>	<input type="checkbox"/>	<input type="checkbox"/>	<input type="checkbox"/>	Disabled	<input checked="" type="checkbox"/>	20
3	<input type="checkbox"/>	<input type="checkbox"/>	<input type="checkbox"/>	<input type="checkbox"/>	<input type="checkbox"/>	<input type="checkbox"/>	<input type="checkbox"/>	<input type="checkbox"/>	<input type="checkbox"/>	<input type="checkbox"/>	<input type="checkbox"/>	<input type="checkbox"/>	<input type="checkbox"/>	<input type="checkbox"/>	<input type="checkbox"/>	<input type="checkbox"/>	<input type="checkbox"/>	<input type="checkbox"/>	<input type="checkbox"/>	<input type="checkbox"/>	Disabled	<input checked="" type="checkbox"/>	20
4	<input type="checkbox"/>	<input type="checkbox"/>	<input type="checkbox"/>	<input type="checkbox"/>	<input type="checkbox"/>	<input type="checkbox"/>	<input type="checkbox"/>	<input type="checkbox"/>	<input type="checkbox"/>	<input type="checkbox"/>	<input type="checkbox"/>	<input type="checkbox"/>	<input type="checkbox"/>	<input type="checkbox"/>	<input type="checkbox"/>	<input type="checkbox"/>	<input type="checkbox"/>	<input type="checkbox"/>	<input type="checkbox"/>	<input type="checkbox"/>	Disabled	<input checked="" type="checkbox"/>	20
5	<input type="checkbox"/>	<input type="checkbox"/>	<input type="checkbox"/>	<input type="checkbox"/>	<input type="checkbox"/>	<input type="checkbox"/>	<input type="checkbox"/>	<input type="checkbox"/>	<input type="checkbox"/>	<input type="checkbox"/>	<input type="checkbox"/>	<input type="checkbox"/>	<input type="checkbox"/>	<input type="checkbox"/>	<input type="checkbox"/>	<input type="checkbox"/>	<input type="checkbox"/>	<input type="checkbox"/>	<input type="checkbox"/>	<input type="checkbox"/>	Disabled	<input checked="" type="checkbox"/>	20
6	<input type="checkbox"/>	<input type="checkbox"/>	<input type="checkbox"/>	<input type="checkbox"/>	<input type="checkbox"/>	<input type="checkbox"/>	<input type="checkbox"/>	<input type="checkbox"/>	<input type="checkbox"/>	<input type="checkbox"/>	<input type="checkbox"/>	<input type="checkbox"/>	<input type="checkbox"/>	<input type="checkbox"/>	<input type="checkbox"/>	<input type="checkbox"/>	<input type="checkbox"/>	<input type="checkbox"/>	<input type="checkbox"/>	<input type="checkbox"/>	Disabled	<input checked="" type="checkbox"/>	20
7	<input type="checkbox"/>	<input type="checkbox"/>	<input type="checkbox"/>	<input type="checkbox"/>	<input type="checkbox"/>	<input type="checkbox"/>	<input type="checkbox"/>	<input type="checkbox"/>	<input type="checkbox"/>	<input type="checkbox"/>	<input type="checkbox"/>	<input type="checkbox"/>	<input type="checkbox"/>	<input type="checkbox"/>	<input type="checkbox"/>	<input type="checkbox"/>	<input type="checkbox"/>	<input type="checkbox"/>	<input type="checkbox"/>	<input type="checkbox"/>	Disabled	<input checked="" type="checkbox"/>	20
8	<input type="checkbox"/>	<input type="checkbox"/>	<input type="checkbox"/>	<input type="checkbox"/>	<input type="checkbox"/>	<input type="checkbox"/>	<input type="checkbox"/>	<input type="checkbox"/>	<input type="checkbox"/>	<input type="checkbox"/>	<input type="checkbox"/>	<input type="checkbox"/>	<input type="checkbox"/>	<input type="checkbox"/>	<input type="checkbox"/>	<input type="checkbox"/>	<input type="checkbox"/>	<input type="checkbox"/>	<input type="checkbox"/>	<input type="checkbox"/>	Disabled	<input checked="" type="checkbox"/>	20
9	<input type="checkbox"/>	<input type="checkbox"/>	<input type="checkbox"/>	<input type="checkbox"/>	<input type="checkbox"/>	<input type="checkbox"/>	<input type="checkbox"/>	<input type="checkbox"/>	<input type="checkbox"/>	<input type="checkbox"/>	<input type="checkbox"/>	<input type="checkbox"/>	<input type="checkbox"/>	<input type="checkbox"/>	<input type="checkbox"/>	<input type="checkbox"/>	<input type="checkbox"/>	<input type="checkbox"/>	<input type="checkbox"/>	<input type="checkbox"/>	Disabled	<input checked="" type="checkbox"/>	20
10	<input type="checkbox"/>	<input type="checkbox"/>	<input type="checkbox"/>	<input type="checkbox"/>	<input type="checkbox"/>	<input type="checkbox"/>	<input type="checkbox"/>	<input type="checkbox"/>	<input type="checkbox"/>	<input type="checkbox"/>	<input type="checkbox"/>	<input type="checkbox"/>	<input type="checkbox"/>	<input type="checkbox"/>	<input type="checkbox"/>	<input type="checkbox"/>	<input type="checkbox"/>	<input type="checkbox"/>	<input type="checkbox"/>	<input type="checkbox"/>	Disabled	<input checked="" type="checkbox"/>	20

Save Reset

Aggregation Group Configuration

Group ID: Trunk ID number. “Normal” means that no aggregation is used. Ten aggregation groups are available for use. Each group contains at least 2 to 20 links (ports). Please note that each port can only be used once in Group ID 1~10.

Port Members: Select ports to belong to a certain trunk.

Mode: Determines the mode for the aggregation group.

Disabled: The group is disabled.

Static: The group operate in static aggregation mode.

LACP (Active): The group operates in LACP active aggregation mode.

LACP (Passive): The group operates in LACP passive aggregation mode.

Revertive: This setting only applies to LACP-enabled ports. If the checkbox is selected, the group will perform automatic link re-calculation when links with higher priority become available.

Max Bundle: This setting only applies to LACP-enabled ports. It determines the maximum number of active bundled LACP ports allowed in an aggregation group.

4.6.3 Aggregation Status

Aggregation Status						Auto-refresh <input type="checkbox"/>	Refresh
Aggr ID	Name	Type	Speed	Configured Ports	Aggregated Ports		
No aggregation groups							

Aggr ID: Display the aggregation ID associated with this aggregation instance.

Name: Display the name of the group ID.

Type: Display the type of aggregation group (Static or LACP).

Speed: Display the speed of the aggregation group.

Configured Ports: The configured ports of the aggregation group.

Aggregated Ports: Aggregated member ports of the aggregation group.

4.6.4 LACP

The Switch supports dynamic Link Aggregation Control Protocol (LACP) which is specified in IEEE 802.3ad. Static trunks have to be manually configured at both ends of the link. In other words, LACP configured ports can automatically negotiate a trunked link with LACP configured ports on another devices. You can configure any number of ports on the Switch as LACP, as long as they are not already configured as part of a static trunk. If ports on other devices are also configured as LACP, the Switch and the other devices will negotiate a trunk link between them.

4.6.4.1 Port Configuration

LACP System Configuration

System Priority

LACP Port Configuration

Port	LACP	Timeout	Prio
*		<>	32768
1	No	Fast	32768
2	No	Fast	32768
3	No	Fast	32768
4	No	Fast	32768
5	No	Fast	32768
6	No	Fast	32768
7	No	Fast	32768
8	No	Fast	32768
9	No	Fast	32768
10	No	Fast	32768
11	No	Fast	32768
12	No	Fast	32768
13	No	Fast	32768
14	No	Fast	32768
15	No	Fast	32768
16	No	Fast	32768
17	No	Fast	32768
18	No	Fast	32768
19	No	Fast	32768
20	No	Fast	32768

LACP System Configuration

System Priority: A LACP system priority is configured on each device running LACP. The system priority can be configured through the user interface. For priority setting, the range is 1 to 65535. The default priority is 32768. The lower the value, the higher the system priority

LACP Port Configuration

Port: The port number. "Port All" settings apply to all ports.

LACP: This field shows whether LACP is now enabled or not.

Timeout: The Timeout controls the period between BPDU transmissions. Fast will transmit LACP packets each second, while Slow will wait for 30 seconds before sending a LACP packet.

Prio: The priority of the port. The lower number means greater priority. This priority value controls which ports will be active and which ones will be in a backup role.

4.6.4.2 System Status

LACP System Status					
Local System ID					
Priority	MAC Address				
32768	00-02-ab-57-d9-e8				
Partner System Status					
Aggr ID	Partner System ID	Partner Prio	Partner Key	Last Changed	Local Ports
No ports enabled or no existing partners					

Local System ID

Priority: The local system priority.

MAC Address: The local system MAC address.

Partner System Status

Aggr ID: Display the aggregation ID associated with the Link Aggregation Group (LAG).

Partner System ID: LAG's partner system ID (MAC address).

Partner Key: The partner key assigned to this LAG.

Partner Prio: The priority value of the partner.

Last Changed: The time since this LAG changed.

Local Ports: The local ports that are a port of this LAG.

4.6.4.3 Internal Status

LACP Internal Port Status											
Port	State	Key	Priority	Activity	Timeout	Aggregation	Synchronization	Collecting	Distributing	Defaulted	Expired
No LACP ports enabled											

Port: Display the switch port number.

State: Display the current port state.

Down: The port is not active.

Active: The port is in active state.

Standby: The port is in standby state.

Key: The key assigned to this port. Only ports with the same key can aggregate together.

Priority: The priority assigned to this aggregation group.

Activity: The LACP mode of the group (Active or Passive).

Timeout: The timeout mode configured for the port (Fast or Slow).

Aggregation: Show whether the system considers this link to be "aggregateable"; i.e., a potential candidate for aggregation.

Synchronization: Show whether the system considers this link to be "IN_SYNC"; i.e., it has been allocated to the correct LAG, the group has been associated with a compatible Aggregator, and the identity of the LAG is consistent with the System ID and operational Key information transmitted.

Collecting: Show if collection of incoming frames on this link is enabled.

Distributing: Show if distribution of outgoing frames on this link is enabled.

Defaulted: Show if the Actor's Receive machine is using Defaulted operational Partner information.

Expired: Show if that the Actor's Receive machine is in the EXPIRED state.

4.6.4.4 Neighbor Status

LACP Neighbor Port Status													Auto-refresh <input type="checkbox"/>	Refresh	
Port	State	Aggr ID	Partner Key	Partner Port	Partner Port Prio	Activity	Timeout	Aggregation	Synchronization	Collecting	Distributing	Defaulted	Expired		
No LACP neighbor status available															

Port: Display the switch port number.

State: Display the current port state.

Down: The port is not active.

Active: The port is in active state.

Standby: The port is in standby state.

Aggr ID: The aggregation group ID which the port is assigned to.

Partner Key: The key assigned to this port by the partner.

Partner Port: The partner port number associated with this link.

Partner Port Priority: The priority assigned to this partner port .

Activity: The LACP mode of the group (Active or Passive).

Timeout: The timeout mode configured for the partner port (Fast or Slow).

Aggregation: Show whether the partner considers this link to be "aggregateable"; i.e., a potential candidate for aggregation.

Synchronization: Show whether the partner considers this link to be "IN_SYNC"; i.e., it has been allocated to the correct LAG, the group has been associated with a compatible Aggregator, and the identity of the LAG is consistent with the System ID and operational Key information transmitted.

Collecting: Show if collection of incoming frames on this link is enabled.

Distributing: Show if distribution of outgoing frames on this link is enabled.

Defaulted: Show if the partners Receive machine is using Defaulted operational Partner information.

Expired: Show if that the partners Receive machine is in the EXPIRED state.

4.6.4.5 Port Statistics

LACP Statistics				
Port	LACP Received	LACP Transmitted	Discarded	
			Unknown	Illegal
No ports enabled				

Port: The port number.

LACP Received: The number of LACP packets received on a port.

LACP Transmitted: The number of LACP packets transmitted by a port

Discarded: The number of unknown and illegal packets that have been discarded on a port.

4.7 Redundancy

Designing redundant paths that can protect networks from unexpected failovers is extremely important in mission-critical networks that need to provide uninterrupted services. However, redundant paths mean that possible loops may occur in networks and bring down networks eventually if they are not treated carefully. In practice, several loop protection methods are implemented to ensure that networks function normally without loops and recover as soon as possible when a point of failure occurs. The most popular ones are STP (802.1d), RSTP (802.1w) and MSTP (802.1s). For industrial applications, the proprietary u-Ring and ERPS (G.8032) are highly recommended since they can achieve faster recovery time than any STP protocol.

In this section, the redundancy-related functions will be introduced individually. The functions covered in this section can be seen from the “Redundancy” menu.

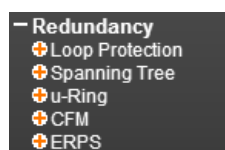

4.7.1 Loop Protection

Loops sometimes occur in a network due to improper connecting, hardware problem or faulty protocol settings. When loops are seen in a switched network, they consume switch resources and thus downgrade switch performance. Loop Protection feature is provided in this switch and can be enabled globally or on a per port basis. Using loop protection enables the switch to automatically detect loops on a network. Once loops are detected, ports received the loop protection packet from the switch can be shut down or looped events can be logged.

4.7.1.1 Configuration

General Settings

Global Configuration		
Enable Loop Protection	Disable	▼
Transmission Time	5	seconds
Shutdown Time	180	seconds

Port Configuration

Port	Enable	Action	Tx Mode
*	<input checked="" type="checkbox"/>	<>	<>
1	<input checked="" type="checkbox"/>	Shutdown Port	Enable
2	<input checked="" type="checkbox"/>	Shutdown Port	Enable
3	<input checked="" type="checkbox"/>	Shutdown Port	Enable
4	<input checked="" type="checkbox"/>	Shutdown Port	Enable
5	<input checked="" type="checkbox"/>	Shutdown Port	Enable
6	<input checked="" type="checkbox"/>	Shutdown Port	Enable
7	<input checked="" type="checkbox"/>	Shutdown Port	Enable
8	<input checked="" type="checkbox"/>	Shutdown Port	Enable
9	<input checked="" type="checkbox"/>	Shutdown Port	Enable
10	<input checked="" type="checkbox"/>	Shutdown Port	Enable
11	<input checked="" type="checkbox"/>	Shutdown Port	Enable
12	<input checked="" type="checkbox"/>	Shutdown Port	Enable
13	<input checked="" type="checkbox"/>	Shutdown Port	Enable
14	<input checked="" type="checkbox"/>	Shutdown Port	Enable
15	<input checked="" type="checkbox"/>	Shutdown Port	Enable
16	<input checked="" type="checkbox"/>	Shutdown Port	Enable
17	<input checked="" type="checkbox"/>	Shutdown Port	Enable
18	<input checked="" type="checkbox"/>	Shutdown Port	Enable
19	<input checked="" type="checkbox"/>	Shutdown Port	Enable
20	<input checked="" type="checkbox"/>	Shutdown Port	Enable

Save Reset

General Settings

Enable Loop Protection: Enable or disable loop protection function.

Transmission Time: The interval between each loop protection PDU sent on each port. Valid values are 1 to 10 seconds.

Shutdown Time: The period for which a port will be kept disabled. Valid values are 0 to 604800 seconds. 0 means that a port is kept disabled until next device restart.

Port Configuration

Port: List the number of each port. "Port *" settings apply to all ports.

Enable: Enable or disable the selected ports' loop protection function.

Action: When a loop is detected on a port, the loop protection will immediately take appropriate actions. Actions will be taken include "Shutdown Port", "Shutdown Port and Log" or "Log Only".

Shutdown Port: A loop-detected port is shutdown for a period of time configured in "Shutdown Time".

Shutdown Port and Log: A loop-detected port is shutdown for a period of time configured in "Shutdown Time" and the event is logged.

Log Only: The event is logged and the port remains enable.

Tx Mode: Enable or disable a port to actively generate loop protection PDUs or to passively look for looped PDUs.

4.7.1.2 Status

Loop Protection Status						
Port	Action	Transmit	Loops	Status	Loop	Time of Last Loop
1	Shutdown	Enabled	0	Down	-	-
2	Shutdown	Enabled	0	Down	-	-
3	Shutdown	Enabled	0	Down	-	-
4	Shutdown	Enabled	0	Down	-	-
5	Shutdown	Enabled	0	Down	-	-
6	Shutdown	Enabled	0	Down	-	-
7	Shutdown	Enabled	0	Down	-	-
8	Shutdown	Enabled	0	Down	-	-
9	Shutdown	Enabled	0	Down	-	-
10	Shutdown	Enabled	0	Down	-	-
11	Shutdown	Enabled	0	Down	-	-
12	Shutdown	Enabled	0	Down	-	-
13	Shutdown	Enabled	0	Down	-	-
14	Shutdown	Enabled	0	Down	-	-
15	Shutdown	Enabled	0	Up	-	-
16	Shutdown	Enabled	0	Down	-	-
17	Shutdown	Enabled	0	Down	-	-
18	Shutdown	Enabled	0	Down	-	-
19	Shutdown	Enabled	0	Down	-	-
20	Shutdown	Enabled	0	Down	-	-

Port: The port number.

Action: Display the configured action that the switch will react when loops occur.

Transmit: Display the configured transmit (Tx) mode.

Loops: The number of loops detected on a port.

Status: The current loop status detected on a port.

Loop: Loops detected on a port or not.

Time of Last Loop: The time of the last loop event detected.

4.7.2 Spanning Tree

For some networking services, always-on connections are required to ensure that end users' online related activities are not interrupted due to unexpected disconnections. In these circumstances, multiple active paths between network nodes are established to prevent disconnections from happening. However, multiple paths interconnected with each other have a high tendency to cause bridge loops that make networks unstable and in worst cases make networks unusable. For example, the MAC address table used by the switch or bridge can fail, since the same MAC addresses (and hence the same network hosts) are seen on multiple ports. Second, a broadcast storm occurs. This is caused by broadcast packets being forwarded in an endless loop between switches. A broadcast storm can consume all available CPU resources and bandwidth.

To solve problems causing by bridge loops, spanning tree allows a network design to include redundant links to provide automatic backup paths if an active link fails, without the danger of bridge loops, or the need for manually enabling/disabling these backup links.

The Spanning Tree Protocol (STP), defined in the IEEE Standard 802.1s, can create a spanning tree within a mesh network of connected layer-2 bridges (typically Ethernet switches) and disable the links which are not part of that tree, leaving a single active path between any two network nodes.

To provide faster spanning tree convergence after a topology change, an evolution of the Spanning Tree Protocol "Rapid Spanning Tree Protocol (RSTP)", is introduced by IEEE 802.1w. RSTP is a refinement of STP; therefore, it shares most of its basic operation characteristics. This essentially creates a cascading effect away from the root bridge where each designated bridge proposes to its neighbors to determine if it can make a rapid transition. This is one of the major elements which allows RSTP to achieve faster convergence times than STP.

The other extension of RSTP is IEEE 802.1s Multiple Spanning Tree protocol (MSTP) that allows different VLANs to travel along separate instances of spanning tree. Unlike STP and RSTP, MSTP eliminates the needs for having different STP for each VLAN. Therefore, in a large networking environment that employs many VLANs, MSTP can be more useful than legacy STP.

4.7.2.1 Bridge Settings

STP Bridge Configuration

Basic Settings

Protocol Version	MSTP ▼
Bridge Priority	32768 ▼
Forward Delay	15
Max Age	20
Maximum Hop Count	20
Transmit Hold Count	6

Advanced Settings

Edge Port BPDU Filtering	<input type="checkbox"/>
Edge Port BPDU Guard	<input type="checkbox"/>
Port Error Recovery	<input type="checkbox"/>
Port Error Recovery Timeout	<input style="width: 100%;" type="text"/>

Basic Settings

Protocol Version: Select the appropriate spanning tree protocol. Protocol versions provided include “STP”, “RSTP”, and “MSTP”.

Bridge Priority: Each switch has a relative priority and cost that is used to decide what the shortest path is to forward a packet. The lowest cost path (lowest numeric value) has a higher priority and is always used unless it is down. If you have multiple bridges and interfaces then you need to adjust the priorities to achieve optimized performance. For MSTP operation, this is the priority of the CIST. Otherwise, this is the priority of the STP/RSTP bridge.

Forward Delay: For STP bridges, the Forward Delay is the time spent in each Listening and Learning state before the Forwarding state is entered. This delay occurs when a new bridge comes onto a network. Valid values are 4-30 seconds.

Max Age: If another switch in the spanning tree does not send out a hello packet for a period of time, it is considered to be disconnected. Valid values are 6 to 40 seconds, and Max Age values must be smaller than or equal to $(\text{Forward Delay}-1)*2$.

Maximum Hop Count: The maximum number of hops allowed for MST region before a BPDU is discarded. Each bridge decrements the hop count by one before passing on the BPDU. When the hop count reaches zero, the BPDU is discarded. The default hop count is 20. The allowed range is 6-40.

Transmit Hold Count: The number of BPDU sent by a bridge port per second. When exceeded, transmission of the next BPDU will be delayed. By default, it is set to 6. The allowed transmit hold count is 1 to 10. Please note that increasing this value might have a significant impact on CPU utilization and decreasing this value might slow down convergence. It is recommended to remain Transmit Hold Count to the default setting.

Advanced Settings

Edge Port BPDU Filtering: The purpose of Port BPDU Filtering is to prevent the switch from sending BPDU frames on ports that are connected to end devices.

Edge Port BPDU Guard: Edge ports generally connect directly to PC, file servers or printers. Therefore, edge ports are configured to allow rapid transition. Under normal situations, edge ports should not receive configuration BPDUs.

However, if they do, this probably is due to malicious attacks or mis-settings. When edge ports receive configuration BPDUs, they will be automatically set to non-edge ports and start a new spanning tree calculation process.

BPDU Guard is therefore used to prevent the device from suffering malicious attacks. With this function enabled, when edge ports receive configuration BPDUs, STP disables those affected edge ports. After a period of recovery time, those disabled ports are re-activated.

Port Error Recovery: When enabled, a port that is in the error-disabled state can automatically be enabled after a certain time.

Port Error Recovery Timeout: The time that has to pass before a port in the error-disabled state can be enabled. The allowed range is 30~86400 seconds.

4.7.2.2 MSTI Mapping

MSTI Configuration

Add VLANs separated by spaces or comma.

Unmapped VLANs are mapped to the CIST. (The default bridge instance).

Configuration Identification

Configuration Name	00-02-ab-d6-58-b0
Configuration Revision	0

MSTI Mapping

MSTI	VLANs Mapped
MSTI1	<input type="text"/>
MSTI2	<input type="text"/>
MSTI3	<input type="text"/>
MSTI4	<input type="text"/>
MSTI5	<input type="text"/>
MSTI6	<input type="text"/>
MSTI7	<input type="text"/>
MSTI8	<input type="text"/>
MSTI9	<input type="text"/>
MSTI10	<input type="text"/>
MSTI11	<input type="text"/>
MSTI12	<input type="text"/>
MSTI13	<input type="text"/>
MSTI14	<input type="text"/>

Configuration Identification

Configuration Name: The name for this MSTI. By default, the switch’s MAC address is used. The maximum length is 32 characters. In order to share spanning trees for MSTI, bridges must have the same configuration name and revision value.

Configuration Revision: The revision number for this MSTI. The allowed range is 0~65535.

MSTI Mapping

MSTI: MSTI instance number.

VLAN Mapped: Specify VLANs mapped to a certain MSTI. Both a single VLAN and a range of VLANs are allowed. Separate VLANs with a comma and use hyphen to denote a range of VLANs. (Example: 2,5,20-40) Leave the field empty for unused MSTI.

4.7.2.3 MSTI Priorities

MSTI Configuration	
MSTI Priority Configuration	
MSTI	Priority
*	<>
CIST	32768
MSTI1	32768
MSTI2	32768
MSTI3	32768
MSTI4	32768
MSTI5	32768
MSTI6	32768
MSTI7	32768

MSTI: Display MSTI instance number. “MSTI *” priority rule applies to all ports.

Priority: Select an appropriate priority for each MSTI instance. Bridge priority is used in selecting the root device, root port, and designated port. The device with the highest priority becomes the root device. However, if all devices have the same priority, the device with the lowest MAC address will then become the root device. Note that lower numeric values indicate higher priority. The bridge priority plus the MSTI instance number, concatenated with the 6-byte MAC address of the switch forms a Bridge Identifier.

4.7.2.4 CIST Ports

STP CIST Port Configuration

CIST Aggregated Port Configuration

Port	STP Enabled	Path Cost	Priority	Admin Edge	Auto Edge	Restricted		BPDU Guard	Point-to-point
						Role	TCN		
-	<input type="checkbox"/>	Auto	128	Non-Edge	<input checked="" type="checkbox"/>	<input type="checkbox"/>	<input type="checkbox"/>	<input type="checkbox"/>	Forced True

CIST Normal Port Configuration

Port	STP Enabled	Path Cost	Priority	Admin Edge	Auto Edge	Restricted Role	TCN	BPDU Guard	Point-to-point
*	<input type="checkbox"/>	<>	<>	<>	<input checked="" type="checkbox"/>	<input type="checkbox"/>	<input type="checkbox"/>	<input type="checkbox"/>	<>
1	<input type="checkbox"/>	Auto	128	Non-Edge	<input checked="" type="checkbox"/>	<input type="checkbox"/>	<input type="checkbox"/>	<input type="checkbox"/>	Auto
2	<input type="checkbox"/>	Auto	128	Non-Edge	<input checked="" type="checkbox"/>	<input type="checkbox"/>	<input type="checkbox"/>	<input type="checkbox"/>	Auto
3	<input type="checkbox"/>	Auto	128	Non-Edge	<input checked="" type="checkbox"/>	<input type="checkbox"/>	<input type="checkbox"/>	<input type="checkbox"/>	Auto
4	<input type="checkbox"/>	Auto	128	Non-Edge	<input checked="" type="checkbox"/>	<input type="checkbox"/>	<input type="checkbox"/>	<input type="checkbox"/>	Auto
5	<input type="checkbox"/>	Auto	128	Non-Edge	<input checked="" type="checkbox"/>	<input type="checkbox"/>	<input type="checkbox"/>	<input type="checkbox"/>	Auto
6	<input type="checkbox"/>	Auto	128	Non-Edge	<input checked="" type="checkbox"/>	<input type="checkbox"/>	<input type="checkbox"/>	<input type="checkbox"/>	Auto
7	<input type="checkbox"/>	Auto	128	Non-Edge	<input checked="" type="checkbox"/>	<input type="checkbox"/>	<input type="checkbox"/>	<input type="checkbox"/>	Auto
8	<input type="checkbox"/>	Auto	128	Non-Edge	<input checked="" type="checkbox"/>	<input type="checkbox"/>	<input type="checkbox"/>	<input type="checkbox"/>	Auto
9	<input type="checkbox"/>	Auto	128	Non-Edge	<input checked="" type="checkbox"/>	<input type="checkbox"/>	<input type="checkbox"/>	<input type="checkbox"/>	Auto
10	<input type="checkbox"/>	Auto	128	Non-Edge	<input checked="" type="checkbox"/>	<input type="checkbox"/>	<input type="checkbox"/>	<input type="checkbox"/>	Auto
11	<input type="checkbox"/>	Auto	128	Non-Edge	<input checked="" type="checkbox"/>	<input type="checkbox"/>	<input type="checkbox"/>	<input type="checkbox"/>	Auto
12	<input type="checkbox"/>	Auto	128	Non-Edge	<input checked="" type="checkbox"/>	<input type="checkbox"/>	<input type="checkbox"/>	<input type="checkbox"/>	Auto
13	<input type="checkbox"/>	Auto	128	Non-Edge	<input checked="" type="checkbox"/>	<input type="checkbox"/>	<input type="checkbox"/>	<input type="checkbox"/>	Auto
14	<input type="checkbox"/>	Auto	128	Non-Edge	<input checked="" type="checkbox"/>	<input type="checkbox"/>	<input type="checkbox"/>	<input type="checkbox"/>	Auto
15	<input type="checkbox"/>	Auto	128	Non-Edge	<input checked="" type="checkbox"/>	<input type="checkbox"/>	<input type="checkbox"/>	<input type="checkbox"/>	Auto
16	<input type="checkbox"/>	Auto	128	Non-Edge	<input checked="" type="checkbox"/>	<input type="checkbox"/>	<input type="checkbox"/>	<input type="checkbox"/>	Auto
17	<input type="checkbox"/>	Auto	128	Non-Edge	<input checked="" type="checkbox"/>	<input type="checkbox"/>	<input type="checkbox"/>	<input type="checkbox"/>	Auto
18	<input type="checkbox"/>	Auto	128	Non-Edge	<input checked="" type="checkbox"/>	<input type="checkbox"/>	<input type="checkbox"/>	<input type="checkbox"/>	Auto
19	<input type="checkbox"/>	Auto	128	Non-Edge	<input checked="" type="checkbox"/>	<input type="checkbox"/>	<input type="checkbox"/>	<input type="checkbox"/>	Auto
20	<input type="checkbox"/>	Auto	128	Non-Edge	<input checked="" type="checkbox"/>	<input type="checkbox"/>	<input type="checkbox"/>	<input type="checkbox"/>	Auto

CIST Aggregated Port Configuration

Port: The port number.

STP Enabled: Enable STP function

Path Cost: Path cost is used to determine the best path between devices. If “Auto” mode is selected, the system automatically detects the speed and duplex mode to decide the path cost. Select “Specific”, if you want to use user-defined value. Valid values are 1 to 200000000. Please note that path cost takes precedence over port priority.

Priority: Select port priority.

Admin Edge: If an interface is attached to end nodes, you can set it to “Edge”.

Auto Edge: Select the checkbox to enable this feature. When enabled, a port is automatically determined to be at the edge of the network when it receives no BPDUs.

Restricted Role: If enabled, this causes the port not to be selected as Root Port for the CIST or any MSTI, even if it has the best spanning tree priority.

Restricted TCN: If enabled, this causes the port not to propagate received topology change notifications and topology changes to other ports.

BPDU Guard: This feature protects ports from receiving BPDUs. It can prevent loops by shutting down a port when a BPDU is received instead of putting it into the spanning tree discarding state. If enabled, the port will disable itself

upon receiving valid BPDU's.

Point-to-Point: Select the link type attached to an interface.

Auto: The switch automatically determines whether the interface is attached to a point-to-point link or shared medium.

Forced True: It is a point-to-point connection.

Forced False: It is a shared medium connection.

4.7.2.5 MSTI Ports

Select a specific MSTI that you want to configure and then click the “Get” button.

Port	Path Cost	Priority
-	Auto	128

Port	Path Cost	Priority
*	<>	<>
1	Auto	128
2	Auto	128
3	Auto	128
4	Auto	128
5	Auto	128
6	Auto	128
7	Auto	128
8	Auto	128
9	Auto	128
10	Auto	128
11	Auto	128
12	Auto	128
13	Auto	128
14	Auto	128
15	Auto	128
16	Auto	128
17	Auto	128
18	Auto	128
19	Auto	128
20	Auto	128

Port: The port number.

Path Cost: Path cost is used to determine the best path between devices. If “Auto” mode is selected, the system automatically detects the speed and duplex mode to decide the path cost. Select “Specific”, if you want to use user-defined value. Valid values are 1 to 200000000. Please note that path cost take precedence over port priority.

Priority: Select port priority.

4.7.2.6 Bridge Status

STP Bridges							Auto-refresh <input type="checkbox"/>	Refresh
MSTI	Bridge ID	Root			Topology Flag	Topology Change Last		
		ID	Port	Cost				
CIST	32768.00-02-AB-D6-68-B0	32768.00-02-AB-D6-68-B0	-	0	Steady	-		

STP Bridge

MSTI: The bridge instance. Click this instance to view STP detailed bridge status.

Bridge ID: The unique bridge ID for this instance consisting a priority value and MAC address of the bridge switch.

Root ID: Display the root device’s priority value and MAC address.

Root Port: The number of the port on this switch that is closest to the root. This switch communicates with the root device through this port. If there is no root port, then this switch has been accepted as the root device of the Spanning Tree network.

Root Cost: The path cost from the root port on the switch to the root device. For the root bridge this is zero. For all other bridges, it is the sum of the port path costs on the least cost path to the root bridge.

Topology Flag: The current state of the Topology Change Notification flag for this bridge instance.

Topology Change Last: The time since this spanning tree was last configured.

Click the MSTI instance to view STP detailed bridge status.

STP Detailed Bridge Status							
STP Bridge Status							
Bridge Instance	CIST						
Bridge ID	32768.00-02-AB-D6-68-B0						
Root ID	32768.00-02-AB-D6-68-B0						
Root Cost	0						
Root Port	-						
Regional Root	32768.00-02-AB-D6-68-B0						
Internal Root Cost	0						
Topology Flag	Steady						
Topology Change Count	0						
Topology Change Last	-						
CIST Ports & Aggregations State							
Port	Port ID	Role	State	Path Cost	Edge	Point-to-Point	Uptime
1	128:001	DesignatedPort	Forwarding	20000	Yes	Yes	0d 00:01:18
3	128:003	BackupPort	Discarding	20000	No	Yes	0d 00:01:18
5	128:005	DesignatedPort	Forwarding	200000	Yes	Yes	0d 00:01:39

STP Detailed Bridge Status

Bridge Instance: The bridge instance.

Bridge ID: The unique bridge ID for this instance consisting a priority value and MAC address of the bridge switch.

Root ID: Display the root device's priority value and MAC address.

Root Cost: The path cost from the root port on the switch to the root device. For the root bridge this is zero. For all other bridges, it is the sum of the port path costs on the least cost path to the root bridge.

Root Port: The number of the port on this switch that is closest to the root. This switch communicates with the root device through this port. If there is no root port, then this switch has been accepted as the root device of the Spanning Tree network.

Regional Root: The Bridge ID of the currently elected regional root bridge, inside the MSTP region of this bridge. (This parameter only applies to the CIST instance.)

Internal Root Cost: The Regional Root Path Cost. For the Regional Root Bridge the cost is zero. For all other CIST instances in the same MSTP region, it is the sum of the Internal Port Path Costs on the least cost path to the Internal Root Bridge. (This parameter only applies to the CIST instance.)

Topology Flag: The current state of the Topology Change Notification flag for this bridge instance.

Topology Change Last: The time since this spanning tree was last configured.

CIST Ports & Aggregations State

Port: Display the port number.

Port ID: The port identifier used by the RSTP protocol. This port ID contains the priority and the port number.

Role: The role assigned by Spanning Tree Algorithm. Roles can be "Designated Port", "Backup Port", "Root Port".

State: Display the current state of a port.

Blocking: Ports only receive BPDU messages but do not forward them.

Learning: Port has transmitted configuration messages for an interval set by the Forward Delay parameter without receiving contradictory information. Port address table is cleared, and the port begins learning addresses

Forwarding: Ports forward packets and continue to learn addresses.

Edge: Display whether this port is an edge port or not.

Point-to-Point: Display whether this point is in point-to-point connection or not. This can be both automatically and manually configured.

Uptime: The time since the bridge port was last initialized.

4.7.2.7 Port Status

STP Port Status			
Port	CIST Role	CIST State	Uptime
1	Non-STP	Forwarding	-
2	Non-STP	Forwarding	-
3	Non-STP	Forwarding	-
4	Non-STP	Forwarding	-
5	Non-STP	Forwarding	-
6	Non-STP	Forwarding	-
7	Non-STP	Forwarding	-
8	Non-STP	Forwarding	-
9	Non-STP	Forwarding	-
10	Non-STP	Forwarding	-
11	Non-STP	Forwarding	-
12	Non-STP	Forwarding	-
13	Non-STP	Forwarding	-
14	Non-STP	Forwarding	-
15	Non-STP	Forwarding	-
16	Non-STP	Forwarding	-
17	Non-STP	Forwarding	-
18	Non-STP	Forwarding	-
19	Non-STP	Forwarding	-
20	Non-STP	Forwarding	-

Port: The port number.

CIST Role: The role assigned by Spanning Tree Algorithm. Roles can be “Designated Port”, “Backup Port”, “Root Port” or “Non-STP”.

CIST State: Display the current state of a port. The CIST state must be one of the following:

Discarding: Ports only receive BPDU messages but do not forward them.

Learning: Port has transmitted configuration messages for an interval set by the Forward Delay parameter without receiving contradictory information. Port address table is cleared, and the port begins learning addresses

Forwarding: Ports forward packets and continue to learn addresses.

Uptime: The time since the bridge port was last initialized.

4.7.2.8 Port Statistics

STP Statistics										
Port	Transmitted				Received				Discarded	
	MSTP	RSTP	STP	TCN	MSTP	RSTP	STP	TCN	Unknown	Illegal
1	0	103	0	0	0	3	0	0	0	0
3	0	3	0	0	0	103	0	0	0	0
5	2228	114	0	0	0	0	0	0	0	0

Port: Display the port number.

Transmitted & Received MSTP/RSTP/STP: The number of MSTP/RSTP/STP configuration BPDU messages transmitted and received on a port.

Transmitted & Received TCN: The number of TCN messages transmitted and received on a port.

Discarded Unknown/Illegal: The number of unknown and illegal packets discarded on a port.

4.7.3 u-Ring

u-Ring is a proprietary redundancy technology that supports 250 units in a ring topology and can bring redundant paths into service within 10 ms when link failures occur. Compared with spanning tree protocol, u-Ring achieves faster recovery time on the network and is more flexible and scalable in network architecture. u-Ring redundancy technology can automatically self-identify the ring Master (the user-defined Master is also supported) and then block a port residing in Master device for backup purposes. Once the disconnection is detected on the network, u-Ring can bring backup ports back into “forwarding” mode so that the disconnected path can keep contact with the whole network.

4.7.3.1 Configuration

u-Ring Configuration

Delete	Instance	Type	Master	East		West	
				Port	Edge	Port	Edge
Delete	1	u-Ring	<input type="checkbox"/>	3		4	
Delete	2	Sub-Ring	<input type="checkbox"/>	5			
Delete	3	u-Chain	<input type="checkbox"/>	6	<input checked="" type="checkbox"/>	7	<input checked="" type="checkbox"/>

Add New Instance

Save Reset

Click “Add New Instance” button to add a new entry.

Instance: The instance number. The total instances supported are 5.

Type: u-Ring supports 3 ring types. They are explained below individually.

u-Ring: u-Ring type is used in a closed ring topology. All participating devices must support u-Ring redundancy technology.

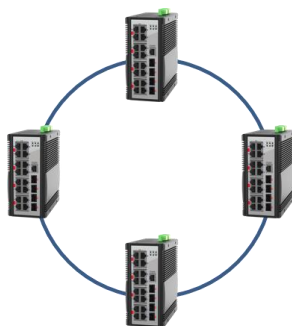

Figure 1. Single ring

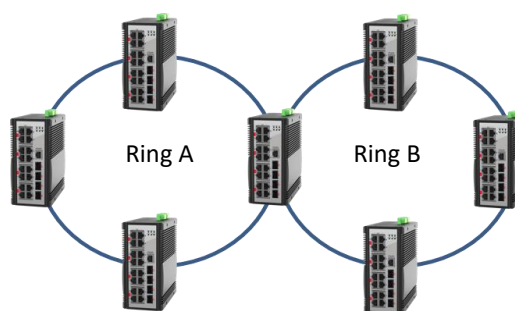

Figure 2. Two rings

u-Chain: u-Chain type is used when u-Ring supported devices interconnect to a network or devices that do not support u-Ring redundancy technology.

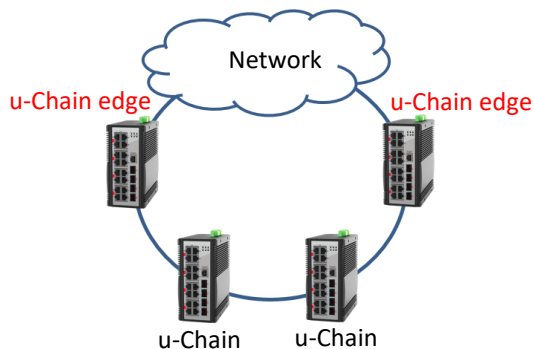

Figure 3. u-Chain ring connects to a network

Sub-Ring: Sub-Ring is used in an open ring and only has one node. In a networking topology, Sub-Ring type must co-exist with u-Ring type or u-Chain type. No third-party devices are used in this ring type.

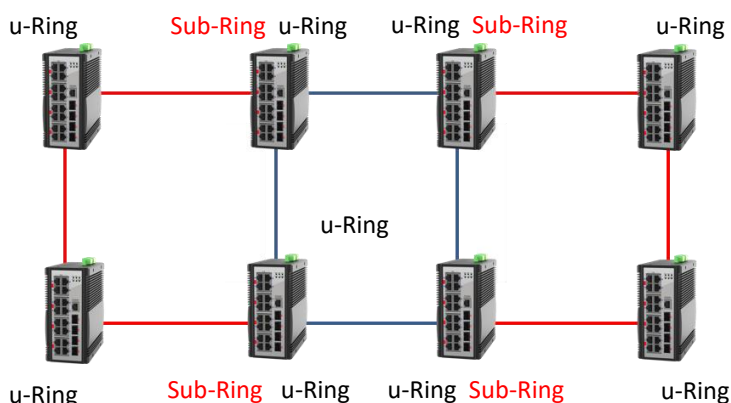

Figure 4. Sub-Ring

Master: The Master is generally used to decide which segment acts as a backup path. The user can manually select the checkbox to set the device in a ring as a Master. However, if all devices' Master checkboxes are left unchecked, the u-Ring protocol will assign one of the devices in the ring as the Master depending on their MAC address. The election process is explained below in "Determining a Master and blocking a port".

Port: Select the west and east port from the pull-down menu.

Edge: This field appears only when you select u-Chain type. Select the checkbox to set the selected port as a u-Chain edge port.

Determining a Master and blocking a port

	u-Ring	u-Chain	Sub-Ring
Step 1. Determining a Master	<ul style="list-style-type: none"> Manually select the Master in a ring. If several devices are set to Master, the u-Ring redundancy protocol decides the Master in a ring depending on devices' MAC address. The device with the biggest MAC address becomes the Master in a ring. If no device in a ring is set to Master, the u-Ring redundancy protocol decides the Master in a ring depending on devices' MAC address. The device with the biggest MAC address becomes the Master in a ring. 	<ul style="list-style-type: none"> Manually select the Master in a ring. The device with a configured edge port that has the biggest MAC address is selected as the Master. If the Master is mis-assigned to the device that does not have an edge, the u-Ring redundancy protocol will ignore this mis-configuration. <p><i>NOTE: When selecting u-Chain type, only the devices with an edge port or edge ports are eligible to be elected as the Master.</i></p>	<ul style="list-style-type: none"> Manually select the Master in a ring. If several devices are set to Master, the u-Ring redundancy protocol decides the Master in a ring depending on devices' MAC address. The device with the biggest MAC address becomes the Master in a ring. If no device in a ring is set to Master, the u-Ring redundancy protocol decides the Master in a ring depending on devices' MAC address. The device with the biggest MAC address becomes the Master in a ring.
Step 2. Blocking a port	The port with higher port number in Master device is blocked.	<ul style="list-style-type: none"> The edge port in Master device is blocked. If the Master has two edge ports, the port with higher port number is blocked. 	The port with higher port number in Master device is blocked.
Example			

4.7.3.2 Status

u-Ring Status									
Instance	Type	Role	East Port			West Port			Healthy
			Number	State	Edge	Number	State	Edge	
1	u-Ring	Master	8	Blocking	---	7	Forwarding	---	●

Instance: The instance number.

Type: Display the type of redundancy ring.

Role: This field can be Master or Slave (paths in Slave device will not be blocked).

East & West Port Number: The configured port number in a instance.

East & West Port State: The current state of the configured port in a ring. The displayed state can be one of the following:

Forwarding: The path is in normal transmission.

Blocking: The path is blocked and acts as a backup path.

Down: No physical connection.

East & West Port Edge: This field shows whether the configured port is an edge port or not.

Healthy: This field graphically displays the current ring status.

✘ : The path is never ringed.

● : The Master is elected and backup path is blocked. The network with a redundant path works normally.

● : The physical link or connection in the ring is down. The status of backup path is changed from “blocked” to “forwarding” status when one of the forwarding paths is down.

4.7.3.3 Details

Instance Status				
Auto-refresh <input type="checkbox"/> Refresh				
Instance	MAC	Type	Role	Healthy
No instance status				

Port Status					
Port	Role	State	Uptime	WTR Time	Failed Location
No port status					

Master Information			
MAC	Backup Port	Topology	Number of Slave
No master information			

Node List	
No.	MAC
No node information	

Instance Status

Instance: Display the instance ID.

MAC: MAC address of the instance.

Type: Display the type of the instance.

Role: When path is formed as a ring, this field shows the role of the instance in a ring. It can be a Master or Slave.

Healthy: The instance can be one of the following states:

✘ : The path is never ringed.

● : The Master is elected and backup path is blocked. The network with a redundant path works normally.

● : The physical link or connection in the ring is down. The status of backup path is changed from “blocked” to “forwarding” status when one of the forwarding paths is down.

Port Status

Port: Display the port number of the instance.

Role: Display the port role of the instance.

State: Display the current port state. The port state can be 'Forwarding', 'Blocking' or 'Down'.

Uptime: Display the time since the port was last forwarded.

WTR Time: The Wait to Restore timingvalue to be used in revertive switching.

Master Information

MAC: Display the MAC address of the master.

Backup Port: Display the type of the instance.

Topology: Type of the protection ring. It can be 'Ring', 'Sub-Ring', or 'Chain'.

Number of Slave: Display how many slaves are in the ring.

Node List

No.: The serial number of the instance.

MAC: The MAC address of the instance.

4.7.4 CFM

4.7.4.1 Global

CFM Global Configuration	
Sender Id TLV	None
Port Status TLV	Enable
Interface Status TLV	Disable
Organisation Specific TLV	Disable
Organisation Specific TLV OUI	000000
Organisation Specific TLV Subtype	0
Organisation Specific TLV Value	

Save Reset

Sender Id TLV: Choose whether and what to use as Sender ID TLVs in CCMs generated by this switch. Can be overridden by Domain and Service level configuration. Options included are None, Chassis, Manage, ChassisManage.

Port Status TLV: Choose whether to send Port Status TLVs in CCMs generated by this switch. Can be overridden by Domain and Service level configuration.

Enable: Send Port Status TLVs in CCMs generated by this switch.

Disable: Do not send Port Status TLVs in CCMs generated by this switch.

Interface Status TLV: Choose whether to send Interface Status TLVs in CCMs generated by this switch. Can be overridden by Domain and Service level configuration.

Enable: Send Interface Status TLVs in CCMs generated by this switch.

Disable: Do not Send Interface Status TLVs in CCMs generated by this switch.

Organisation Specific TLV: Choose whether to send Organisation Specific TLVs in CCMs generated by this switch. Can be overridden by Domain and Service level configuration.

Enable: Send Organisation Specific TLVs in CCMs generated by this switch.

Disable: Do not send Organisation Specific TLVs in CCMs generated by this switch.

Organisation Specific TLV OUI: This is the three-bytes OUI transmitted with the Organization-Specific TLVs. Enter as 6 characters 0-9, a-f.

Organisation Specific TLV Subtype: This is the subtype transmitted with the Organization-Specific TLV. Can be any value in range [0; 255]

Organisation Specific TLV Value: This is the value transmitted in the Organization-Specific TLVs. Value is a printable character string of length 0-63.

4.7.4.2 Domain

CFM Domain Configuration Refresh

Delete	Domain	Format	Name	Level	TLV option select				
					Sender Id	Port Status	Interface Status	Org. Specific	
*									
Delete	domain	String	DEFAULT	0	Defer	Defer	Defer	Defer	

Add New Entry

Save Reset

Delete: Check to delete the entry. It will be deleted during the next save.

Domain: Name of Domain. Value is a single word which begins with an alphabetic letter A-Z or a-z with length 1-15.

Format: Select the MD name format. To mimic Y.1731 MEG IDs, use type None.

Name: The contents of this parameter depends on the value of the format member. If format is None: Name is not used, but will be set to all-zeros behind the scenes. This format is typically used by Y.1731-kind-of-PDUs. If format is String: Name must contain a string from 1 to 43 characters long.

Level: MD/MEG level of this domain. Valid values are restricted to 0-7.

TLV option select: This section includes four TLV options.

Sender Id: Default Sender ID TLV format to be used in CCMs generated by this Domain (may be overridden in service)

None: Do not include Sender ID TLVs.

Chassis: Enable Sender ID TLV and send Chassis ID (MAC Address).

Manage: Enable Sender ID TLV and send Management address (IPv4 Address).

ChassisManage: Enable Sender ID TLV and send both Chassis ID (MAC Address) and Management Address (IPv4 Address).

Defer: Let the global configuration decide if Sender ID TLVs shall be included (may be overridden in service).

Port Status: Include or exclude Port Status TLV in CCMs generated by this Domain or let higher level determine (may be overridden in Service).

Disable: Do not include Port Status TLVs.

Enable: Include Port Status TLVs.

Defer: Let the global configuration decide if Port Status TLVs shall be included (may be overridden in Service).

Interface Status: Include or exclude Interface Status TLV in CCMs generated by this Domain or let higher level determine (may be overridden in Service).

Disable: Do not include Interface Status TLVs.

Enable: Include Interface Status TLVs.

Defer: Let the global configuration decide if Interface Status TLVs shall be included (may be overridden in Service).

Org. Specific: Exclude Organization-Specific TLV in CCMs generated by this Domain or let higher level determine (may be overridden in Service).

Disable: Do not include Organization-Specific TLVs.

Defer: Let the global configuration decide if Organization-Specific TLVs shall be included (may be overridden in service).

4.7.4.3 Service

Delete	Domain	Service	Format	Name	VLAN	CCM Interval	TLV option select			
							Sender Id	Port Status	Interface Status	Org. Specific
<input type="checkbox"/>			Primary Vid		0	1 sec	Defer	Defer	Defer	Defer

Delete: Check to delete the entry. It will be deleted during the next save.

Domain: Name of Domain under which this Service resides.

Service: Name of Service. Value is a single word which begins with an alphabetic letter A-Z or a-z with length 1-15.

Format: Select the short Service name format. This decides how the value of the Name parameter will be interpreted. To mimic Y.1731 MEG IDs, create an MD instance with an empty name and use Y1731 ICC or Y1731 ICC CC. Possible values are: String, Two Octets, Y1731 ICC, Y1731 ICC CC

Name: The contents of this parameter depends on the value of the format member. Besides the limitations explained for each of them, the following applies in general:

If the Domain Format is None, the size of this cannot exceed 45 bytes.

If the Domain Format is not None, the size of this cannot exceed 44 bytes.

If Format is String, the following applies:

length must be in range [1; 44]

Contents must be in range [32; 126]

If Format is Two Octets, the following applies: Name[0] and Name[1] will both be interpreted as unsigned 8-bit integers (allowing a range of [0; 255]). Name[0] will be placed in the PDU before Name[1].

The remaining available bytes in name will not be used.

If Format is Y1731 ICC, the following applies:

length must be 13.

Contents must be in range [a-z,A-Z,0-9]

Y.1731 specifies that it is a concatenation of ICC (ITU Carrier Code) and UMC (Unique MEG ID Code): ICC: 1-6

bytes , UMC: 7-12 bytes

In principle UMC can be any value in range [1; 127], but this device does not allow for specifying length of ICC, so the underlying code doesn't know where ICC ends and UMC starts.

The Domain Format must be None.

If Format is Y1731 ICC, the following applies:

length must be 15.

First 2 chars (CC): Must be amongst [A-Z]

Next 1-6 chars (ICC): Must be amongst [a-z,A-Z,0-9]

Next 7-12 chars (UMC): Must be amongst [a-z,A-Z,0-9]

There may be ONE (slash) present in name[3-7].

The Domain format must be None.

VLAN: The MA's primary VID. A primary VID of 0 means that all MEPs created within this MA will be created as port MEPs (interface MEPs). There can only be one port MEP per interface. A given port MEP may still be created with tags, if that MEP's VLAN is non-zero." A non-zero primary VID means that all MEPs created within this MA will be created as VLAN MEPs. A given MEP may be configured with another VLAN than the MA's primary VID, but it is impossible to have untagged VLAN MEPs.

CCM Interval: The CCM rate of all MEPs bound to this Service.

TLV option select: Options included are as follows:

Sender Id: Default Sender ID TLV format to be used in CCMs generated by this Service.

None: Do not include Sender ID TLVs.

Chassis: Enable Sender ID TLV and send Chassis ID (MAC Address).

Manage: Enable Sender ID TLV and send Management address (IPv4 Address).

ChassisManage: Enable Sender ID TLV and send both Chassis ID (MAC Address) and Management Address (IPv4 Address).

Defer: Let the Domain configuration decide if Sender ID TLVs shall be included.

Port Status: Include or exclude Port Status TLV in CCMs generated by this Service or let higher level determine.

Disable: Do not include Port Status TLVs.

Enable: Include Port Status TLVs.

Defer: Let the Domain configuration decide if Port Status TLVs shall be included.

Interface Status: Include or exclude Interface Status TLV in CCMs generated by this Service or let higher level determine.

Disable: Do not include Interface Status TLVs.

Enable: Include Interface Status TLVs.

Defer: Let the Domain configuration decide if Interface Status TLVs shall be included.

Org. Specific: Exclude Organization-Specific TLV in CCMs generated by this Service or let higher level determine.

Disable: Do not include Organization-Specific TLVs.

Defer: Let the Domain configuration decide if Organization-Specific TLVs shall be included.

4.7.4.4 MEP

Delete: Check to delete the entry. It will be deleted during the next save.

Domain: Name of Domain under which this MEP resides.

Service: Name of Service under which this MEP resides.

MEPID: The identification of this MEP. Must be an integer 1~8091.

Direction: Set whether this MEP is an Up- or a Down-MEP.

Port: Port on which this MEP resides.

VLAN: VLAN ID. Use the value 0 to indicate untagged traffic (implies a port MEP).

PCP: Choose PCP value in PDUs' VLAN tag. Not used if untagged.

SMAC: Set a Source MAC address to be used in CCM PDUs originating at this MEP. Must be a unicast address. Format is XX:XX:XX:XX:XX:XX. If all-zeros, the switch port's MAC address will be used instead.

Alarm Control: This can divide into three parts.

Level: If a defect is detected with a priority higher than this level, a fault alarm notification will be generated. Valid range is [1; 6] with 1 indicating that any defect will cause a fault alarm and 6 indicating that no defect can cause a fault alarm. See 802.1Q-2018, clause 20.9.5, LowestAlarmPri

The possible defects and their priorities are:

Short name	Description	Priority
DefRDICCM	Remote Defect Indication	1
DefMACstatus	MAC Status	2
DefRemoteCCM	Remote CCM	3
DefErrorCCM	Error CCM Received	4
DefXconCCM	Cross Connect CCM Received	5

Present: The time in milliseconds that defects must be present before a fault alarm notification is issued. Default is 2500 ms.

Absent: The time in milliseconds that defects must be absent before a fault alarm notification is reset. Default is 10000 ms.

State Control:

CCM: Enable or disable generation of continuity-check messages (CCMs)

Admin: Enable or disable this MEP. When this MEP is enabled, it will check received/missing CCMs and can raise defects.

Remote MEPID: Specify the Remote MEP that this MEP is expected to receive CCM PDUs from. Must be an integer 0~8091; where 0 means undefined. The value of Remote MEPID must be different from the value of MEPID.

4.7.4.5 Status

Monitor CFM Status on this page.

Domain	Service	MEPID	Port	State		SMAC	Defects		CCM Rx			CCM Tx
				Active	Fng		Highest	Defects	Valid	Invalid	Errors	
No entry exists												

Domain: Name of Domain under which this MEP resides.

Service: Name of Service under which this MEP resides.

MEPID: The identification of this MEP.

Port: Port on which this MEP resides.

State:

Active: Operational state of the MEP.

OFF: This indicates that the MEP Admin State is disabled.

Down: The MEP Admin State is enabled, but an error state exists.

UP: The MEP Admin State is enabled, and no errors and defects exists.

Fng: Holds the current state of the Fault Notification Generator State Machine. Values will be one of the following:

state:	Description
reset:	No defect has been present since reset timer expired or the State Machine was last reset.
defect:	A defect is present, but not for a long enough time to be reported.
reportDefect:	A transient state during which the defect is reported.
defectReported:	A defect is present, and some defect has been reported.
defectClearing:	No defect is present, but the ResetTime timer has not yet expired.

SMAC: This MEP's MAC address.

Defects:

Highest: Highest priority defect that has been present since the MEP's fault notification generator state machine was last in the reset state.

Defects: A MEP can detect and report a number of defects, and multiple defects can be present at the same time. This is indicated the following letter code.

Code	Defect	Description
-	Defect not present	Defect not present
R	someRDIdefect	RDI received from at least one remote MEP
M	someMACstatusDefect	Received Port Status TLV != psUp or Interface Status TLV != isUp
C	someRMEPCCMdefect	Valid CCM is not received within 3.5 times CCM interval from at least one remote MEP
E	errorCCMdefect	Received CCM from an unknown remote MEP-ID or CCM interval mismatch
X	xconCCMdefect	Received CCM with an MD/MEG level smaller than configured or wrong MAID/MEGID (cross-connect)

CCM Rx:

Valid: Total number of CCMs that hit this MEP and passed the validation test.

Invalid: Total number of CCMs that hit this MEP and didn't pass the validation test.

Errors: Total number of out-of-sequence errors seen from RMEPs.

CCM Tx: Total number of CCM PDUs transmitted by this MEP.

4.8 ERPS

Ethernet Ring Protection Switching (ERPS), defined in ITU-T G8032, implements protection switching mechanism for Ethernet traffic in a ring topology. By performing ERPS function, potential loops in a network can be avoided by blocking traffic to flow to ring protection link (RPL) so as to protect the entire Ethernet ring.

In a ring topology that runs ERPS, only one switch is assigned as an owner that is responsible for blocking traffic in RPL so as to avoid loops. The switch adjacent to the RPL owner is called RPL neighbor node that is responsible for blocking its end of the RPL under normal condition. Other participating switches adjacent to RPL owner or neighbor in a ring are members or RPL next-neighbor nodes to this topology and normally forward receive traffic.

Nodes on the ring periodically use control messages called Ring Automatic Protection Switching message to ensure that a ring is up and loop-free. Once RPL owner misses poll packets or learns from fault detection packets, RPL owner detects signal failure (SF) in a ring. Upon learning of a fault, the RPL owner unblocks ring protection link (RPL) allowing protected VLAN traffic through.

ERPS, like STP, provides a loop-free network by using polling packets to detect faults. However, when a fault occurs, ERPS heals itself by sending traffic over a protected reverse path instead of making a calculation to find out the forwarding path. Because of this fault detection mechanism, ERPS can converge in less than 50 milliseconds and recover quickly to forward traffic.

The following sections will provide a reference to ERPS web configurations.

4.8.1 Configuration

Configuration

ERPS #: The ID of ERPS. The allowed value is from 1 - 64.

Version: ERPS protocol version. v1 and v2 are supported.

Type: Type of ring. Possible values:

Major: ERPS major ring (G.8001-2016, clause 3.2.39)

Sub: ERPS sub-ring (G.8001-2016, clause 3.2.66)

InterSub: ERPS sub-ring on an interconnection node (G.8001-2016, clause 3.2.66)

VC: Controls whether to use a Virtual Channel with a sub-ring.

Interconnect Instance: For a sub-ring on an interconnection node, this must reference the instance ID of the ring to which this sub-ring is connected.

Interconnect Prop: Controls whether the ring referenced by Interconnect Instance shall propagate R-APS flush PDUs whenever this sub-ring's topology changes.

Ring Id: The Ring ID is used - along with the control VLAN - to identify R-APS PDUs as belonging to a particular ring.

Node Id: The Node ID is used inside the R-APS specific PDU to uniquely identify this node (switch) on the ring.

Level: MD/MEG Level of R-APS PDUs we transmit.

Control VLAN: The VLAN on which R-APS PDUs are transmitted and received on the ring ports.

Control PCP: The PCP value used in the VLAN tag of the R-APS PDUs.

Rev: Revertive (true) or Non-revertive (false) mode.

Guard: Guard time in ms. Valid range is 10 - 2000 ms.

WTR: Wait-to-Restore time in seconds. Valid range 1 - 720 sec.

Hold Off: Hold off time in ms. Value is rounded down to 100ms precision. Valid range is 0 - 10000 ms.

Enable: The administrative state of this ERPS. Check to make it function normally and uncheck to make it cease functioning.

Signal Fail Trigger

Type: Selects whether Signal Fail (SF) comes from the link state of a given interface, or from a Down-MEP.

Domain, Service, MEPID: Identification of the MEP instance to provide Signal Fail, if Type is MEP.

Protected VLANs: VLANs which are protected by this ring instance. At least one VLAN must be protected. Specify as a comma separated list of vlan numbers or vlan ranges. Ex.: 1,4,7,30-70

Ring Protection Link

RPL Mode: There are three RPL modes. See below for explanation.

None: This switch doesn't have the RPL port in the ring

Owner: This switch is RPL owner for the ring (G.8001-2016, clause 3.2.61)

Neighbor: This switch is RPL neighbor for the ring (G.8001-2016, clause 3.2.60)

RPL Port: Indicates whether it is port0 or port1 that is the Ring Protection Link. Not used if RPL Mode is None.

4.8.2 Status

ERPS Status													Tx Info	
ERPS #	Oper	Warning	State	TxRapsActive	cFOP To	UpdateTimeSecs	Request	Version	Rb	Dnf	Bpr	Node Id	SMAC	
No entry exists														

This shows the current status of the ERPS instances.

ERPS #: The ID of the ERPS. Click on link to get to ERPS detailed instance page, you can reset counters and issue commands.

Oper: The operational state of ERPS instance.

up: Active.

down: Disabled or Internal error.

Warning: Operational warnings of ERPS instance.

up: No warnings.

down: There are warnings, use tooltip to see.

State: Specifies protection/node state of ERPS.

TxRapsActive: Specifies whether we are currently supposed to be transmitting R-APS PDUs on our ring ports.

cFOPTo: Failure of Protocol - R-APS Rx Time Out.

UpdateTimeSecs: Time in seconds since boot that this structure was last updated.

Request: Request/state according to G.8032, table 10-3.

Version: Version of received/used R-APS Protocol. 0 means v1, 1 means v2, etc.

Rb: RB (RPL blocked) bit of R-APS info. See Figure 10-3 of G.8032.

Dnf: DNF (Do Not Flush) bit of R-APS info. See Figure 10-3 of G.8032."

Bpr: BPR (Blocked Port Reference) of R-APS info. See Figure 10-3 of G.8032.

Node Id: Node ID of this request.

SMAC: The Source MAC address used in the request/state.

4.9 IPMC Profile

The "IPMC Profile" includes the following two sub menus.

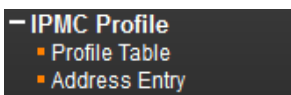

4.9.1 Profile Table

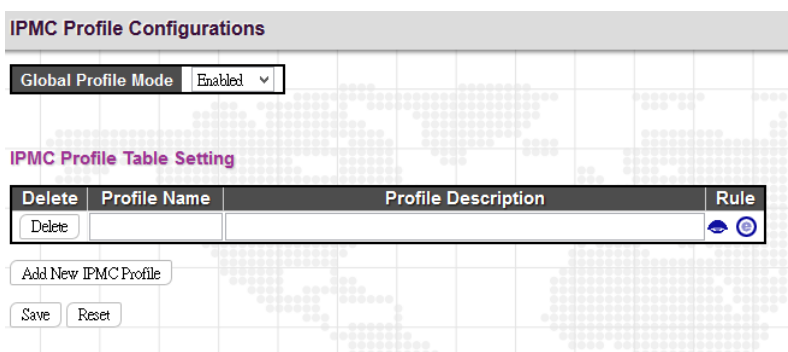

IPMC Profile Configuration

Global Profile Mode: Enable or disable IPMC Profile feature globally.

IPMC Profile Table Setting

Profile Name: Enter a name for this profile.

Profile Description: Enter a brief description for this profile.

Click the "Add New IPMC Profile" to insert a new entry to the table.

Select the "Delete" checkbox to delete an entry.

Click the "e" button to edit this profile's detailed settings.

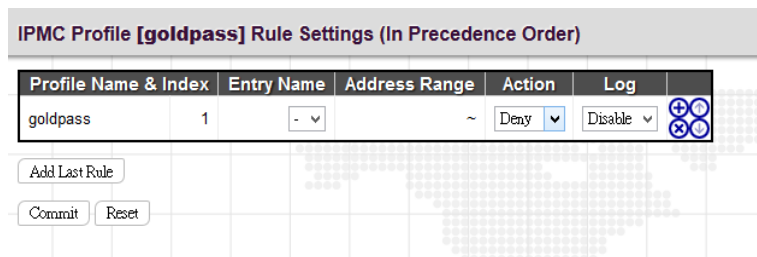

Profile Name & Index: Display the profile name and index.

Entry Name: The name used in specifying the address range. Only the existing profile address entries are selectable in the drop-down menu.

Address Range: Specify the multicast IP range. The available IP range is from 224.0.0.0~239.255.255.255

Action: Select the action taken upon receiving the Join/Report frame that has the group address matches the address range of the rule.

Permit: Group address matches the range specified in the rule will be learned.

Deny: Group address matches the range specified in the rule will be dropped.

Log: Select the logging preference receiving the Join/Report frame that has the group address matches the address range of the rule.

Enable: Corresponding information of the group address, that matches the range specified in the rule, will be logged.

Disable: Corresponding information of the group address, that matches the range specified in the rule, will not be logged.

You can manage rules and the corresponding precedence order by using the following buttons:

- ⊕: Insert a new rule before the current entry of rule.
- ⊗: Delete the current entry of rule.
- ⬆: Moves the current entry of rule up in the list.
- ⬇: Moves the current entry of rule down in the list.

4.9.2 Address Entry

IPMC Profile Address Configuration

Navigate Address Entry Setting in IPMC Profile by entries per page.

Delete	Entry Name	Start Address	End Address
<input type="checkbox"/>	e1	224.0.0.1	239.0.0.1
Delete			

Entry Name: Enter a name which is used for indexing the address entry table.

Start Address: Enter the starting IPv4 or IPv6 multicast address used in this address range.

End Address: Enter the ending IPv4 or IPv6 multicast address used in this address range.

Click the "Add new Address (Range) Entry" button to insert a new entry.

Select the "Delete" checkbox to delete an entry during the next save.

4.10 MVR

Multicast VLAN Registration protocol (MVR) allows a media server to transmit multicast stream in a single multicast VLAN when clients receiving multicast VLAN stream can reside in different VLANs. Clients in different VLANs intend to join or leave the multicast group simply by sending the IGMP Join or Leave message to a receiver port. The receiver port that belongs to one of the multicast groups can receive multicast stream from the media server.

MVR further isolates users who are not intended to receive multicast traffic and hence provide data security by VLAN segregation that allows only multicast traffic into other VLANs to which the subscribers belong. Even though common multicast streams are passed onto different VLAN groups from the MVR VLAN, users in different IEEE 802.1Q or private VLANs cannot exchange any information (except through upper-level routing services).

The "MVR" menu contains the following sub menus.

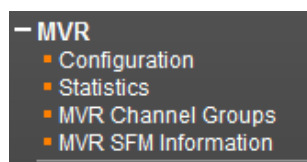

4.10.1 Configuration

MVR Configurations

MVR Mode

VLAN Interface Setting (Role [I:Inactive / S:Source / R:Receiver])

Delete	MVR VID	MVR Name	IGMP Address	Mode	Tagging	Priority	LLQI	Interface Channel Profile
<input type="button" value="Add New MVR VLAN"/>								

Immediate Leave Setting

Port	Immediate Leave
*	<> ▼
1	Disabled ▼
2	Disabled ▼
3	Disabled ▼
4	Disabled ▼
5	Disabled ▼
6	Disabled ▼
7	Disabled ▼
8	Disabled ▼
9	Disabled ▼
10	Disabled ▼
11	Disabled ▼
12	Disabled ▼
13	Disabled ▼
14	Disabled ▼
15	Disabled ▼
16	Disabled ▼
17	Disabled ▼
18	Disabled ▼
19	Disabled ▼
20	Disabled ▼

Save Reset

MVR Configurations

MVR Mode: Enable or disable MVR feature globally on this device. Any multicast data from source ports will be sent to associated receiver ports registered in the table. By default, MVR feature is turned off.

VLAN Interface Setting

MVR ID: Specify multicast VLAN ID. Please note that MVR source ports are not recommended to be used as management VLAN ports. MVR source ports should be configured as members of the MVR VLAN, but MVR receiver ports should not be manually configured as members of this VLAN.

MVR Name: Optionally specify a user-defined name for this multicast VLAN. The maximum length of the MVR name string is 32. Both alphabets and numbers are allowed for use.

IGMP Address: Specify the IPv4 unicast address as source address used in IP header for IGMP control frames.

Mode: Two MVR operation modes are provided.

Dynamic: MVR allows dynamic MVR membership reports on source ports. (This is the default mode.)

Compatible: MVR membership reports are forbidden on source ports.

Tagging: Specify whether IGMP/MLD control frames will be sent tagged with MVR VID or untagged.

Priority: Specify the priority for transmitting IGMP/MLD control frames. By default, priority is set to 0. Allowed priority values is 0 -7.

LLQI: LLQI stands for Last Listener Query Interval and is to configure the maximum time to wait for IGMP/MLD report memberships on a receiver port before removing the port from multicast group membership. By default, LLQI is set to 5 tenths of a second (0.5 second). The allowed range is 0~31744 tenths of a second.

Interface Channel Profile: Select an IPMC profile from the drop-down menu. Click the  button to view a summary about the selected IPMC profile settings.

Port Role: Click the Port Role symbol to change the role status.

Inactive (I): By default, all ports are set to inactive. Inactive ports do not participate in MVR operations.

Source (S): Set a port (uplink ports) to source port. Source ports will receive and send multicast data. Subscribers can not directly be connected to source ports. Please also note that source ports cannot be management ports at the same time.

Receiver (R): Set a port to receiver port. Client or subscriber ports are configured to receiver ports so that they can issue IGMP/MLD messages to receive multicast data.

Immediate Leave Setting

Port: The port number. "Port *" rule applies to all ports.

Immediate Leave: Enable for disable immediate leave function. When enabled, the device immediately removes a port from a multicast stream as soon as it receives leave message for that group. This option only applies to an interface configured as MVR receivers.

4.10.2 MVR Statistics

MVR Statistics						
VLAN ID	IGMP/MLD Queries Received	IGMP/MLD Queries Transmitted	IGMPv1 Joins Received	IGMPv2/MLDv1 Reports Received	IGMPv3/MLDv2 Reports Received	IGMPv2/MLDv1 Leaves Received
200	0 / 0	0 / 0	0	0 / 0	0 / 0	0 / 0

This page displays MVR statistics information on queries, joins, reports and leaves messages.

VLAN ID: Display VLAN ID that is used for processing multicast traffic.

IGMP/MLD Queries Received: The number of received queries for IGMP and MLD.

IGMP/MLD Queries Transmitted: The number of transmitted queries for IGMP/MLD.

IGMPv1 Joins Received: The number of IGMPv1 received joins

IGMPv2/MLDv1 Reports Received: The number of IGMPv2 and MLDv1 received reports.

IGMPv3/MLDv2 Reports Received: The number of IGMPv3 and MLDv2 received reports.

IGMPv2/MLDv1 Leaves Received: The number of IGMPv2 and MLDv1 received leaves.

4.10.3 MVR Channel Groups

MVR Channels (Groups) Information		Auto-refresh <input type="checkbox"/> Refresh << >>																			
Start from VLAN <input type="text" value="1"/> and Group Address <input type="text" value="::"/>		with <input type="text" value="20"/> entries per page.																			
VLAN ID	Groups	1	2	3	4	5	6	7	8	9	10	11	12	13	14	15	16	17	18	19	20
No more entries																					

Start from VLAN ____ and Group Address _____ with 20 entries per page.

This table displays MVR channels (groups) information and is sorted by VLAN ID.

VLAN ID: VLAN ID of the group.

Groups: Group ID

Port Members: Ports that belong to this group.

4.10.4 MVR SFM Information

MVR SFM Information						
Start from VLAN <input type="text" value="1"/> and Group Address <input type="text" value="::"/>						
with <input type="text" value="20"/> entries per page.						
VLAN ID	Group	Port	Mode	Source Address	Type	Hardware Filter/Switch
No more entries						

VLAN ID: VLAN ID of the group.

Group: The group address.

Port: Switch port number.

Mode: Indicates the filtering mode maintained per (VLAN ID, port number, Group Address) basis. It can be either Include or Exclude.

Source Address: The source IP Address. Currently, the system limits the total number of source IP addresses for filtering to be 128. When there is no source filtering address, "None" is shown in the Source Address field.

Type: Indicates the Type. It can be either Allow or Deny.

Hardware Filter/Switch: Indicate whether data plane destined to the specific group address from the source IPv4/IPv6 address could be handled by chip or not.

4.11 IPMC

The "IPMC" menu includes IGMP Snooping and MLD Snooping sub menu. Select the appropriate menu to set up detailed configurations.

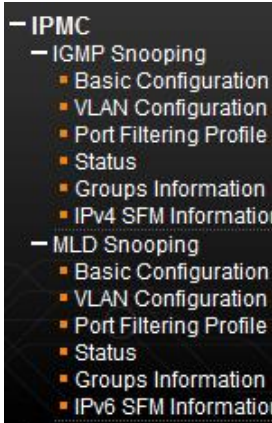

4.11.1 IGMP Snooping

The Internet Group Management Protocol (IGMP) is a communications protocol used to manage the membership of Internet Protocol multicast groups. IGMP is used by IP hosts and adjacent multicast routers to establish multicast group memberships. It can be used more efficiently when supporting activities, such as, online streaming video and gaming.

IGMP Snooping is the process of listening to IGMP traffic. IGMP snooping, as implied by the name, is a feature that allows the switch to “listen in” on the IGMP conversation between hosts and routers by processing the layer 3 packets that IGMP packets sent in a multicast network.

When IGMP snooping is enabled in a switch, it analyses all the IGMP packets between hosts connected to the switch and multicast routers in the network. When a switch receives an IGMP report for a given multicast group from a host, the switch adds the host's port number to the multicast list for that group. When the switch hears an IGMP Leave, it removes the host's port from the table entry.

IGMP snooping can reduce multicast traffic from streaming and other bandwidth intensive IP applications more effectively. A switch using IGMP snooping will only forward multicast traffic to the hosts in that traffic. This reduction of multicast traffic reduces the packet processing at the switch (at the cost of needing additional memory to handle the multicast tables) and also decreases the workload at the end hosts since their network cards (or operating system) will not receive and filter all the multicast traffic generated in the network.

4.11.1.1 Basic Configuration

The screenshot displays the IGMP Snooping Configuration web interface. It is divided into two main sections: Global Configuration and Port Related Configuration.

Global Configuration:

- Snooping Enabled:
- Unregistered IPMCv4 Flooding Enabled:
- IGMP SSM Range: 232.0.0.0 / 8
- Leave Proxy Enabled:
- Proxy Enabled:

Port Related Configuration:

Port	Router Port	Fast Leave	Throttling
*	<input type="checkbox"/>	<input type="checkbox"/>	<>
1	<input type="checkbox"/>	<input type="checkbox"/>	unlimited
2	<input type="checkbox"/>	<input type="checkbox"/>	unlimited
3	<input type="checkbox"/>	<input type="checkbox"/>	unlimited
4	<input type="checkbox"/>	<input type="checkbox"/>	unlimited
5	<input type="checkbox"/>	<input type="checkbox"/>	unlimited
6	<input type="checkbox"/>	<input type="checkbox"/>	unlimited
7	<input type="checkbox"/>	<input type="checkbox"/>	unlimited
8	<input type="checkbox"/>	<input type="checkbox"/>	unlimited
9	<input type="checkbox"/>	<input type="checkbox"/>	unlimited
10	<input type="checkbox"/>	<input type="checkbox"/>	unlimited
11	<input type="checkbox"/>	<input type="checkbox"/>	unlimited
12	<input type="checkbox"/>	<input type="checkbox"/>	unlimited
13	<input type="checkbox"/>	<input type="checkbox"/>	unlimited
14	<input type="checkbox"/>	<input type="checkbox"/>	unlimited
15	<input type="checkbox"/>	<input type="checkbox"/>	unlimited
16	<input type="checkbox"/>	<input type="checkbox"/>	unlimited
17	<input type="checkbox"/>	<input type="checkbox"/>	unlimited
18	<input type="checkbox"/>	<input type="checkbox"/>	unlimited
19	<input type="checkbox"/>	<input type="checkbox"/>	unlimited
20	<input type="checkbox"/>	<input type="checkbox"/>	unlimited
21	<input type="checkbox"/>	<input type="checkbox"/>	unlimited

Buttons: Save, Reset

IGMP Snooping Configuration: Global Configuration

Snooping Enabled: Select the checkbox to globally enable IGMP Snooping feature. When enabled, this device will monitor network traffic and determine which hosts will receive multicast traffic. The switch can passively monitor or snoop on IGMP Query and Report packets transferred between IP multicast routers and IP multicast service subscribers to identify the multicast group members. The switch simply monitors the IGMP packets passing through it, picks out the group registration information and configures the multicast filters accordingly.

Unregistered IPMCv4 Flooding Enabled: Set forwarding mode for unregistered (not-joined) IP multicast traffic. Select the checkbox to flood traffic.

IGMP SSM Range: SSM (Source-Specific Multicast) Range allows the SSM-aware hosts and routers run the SSM service model for the groups in the address range.

Leave Proxy Enabled: Suppresses leave messages unless received from the last member port in the group. IGMP leave proxy suppresses all unnecessary IGMP leave messages so that a non-querier switch forwards an IGMP leave packet only when the last dynamic member port leaves a multicast group.

Proxy Enabled: When enabled, the switch performs like “IGMP Snooping with Proxy Reporting” (as defined in DSL Forum TR-101, April 2006).

Port Related Configuration

Port: The port number.

Router Port: Tick the checkbox on a given port to assign it as a router port. If IGMP snooping cannot locate the IGMP

querier, you can manually designate a port which is connected to a known IGMP querier (i.e., a multicast router/switch). This interface will then join all the current multicast groups supported by the attached router/switch to ensure that multicast traffic is passed to all appropriate interfaces within the switch.

Fast Leave: Enable fast leave function if the checkbox is ticked. When a leave packet is received, the switch immediately removes it from a multicast service without sending an IGMP group-specific (GS) query to that interface.

Throttling: This field limits the maximum number of multicast groups that a port can join at the same time. When the maximum number is reached on a port, any new IGMP join reports will be dropped. By default, unlimited is selected. Other allowed options are 1–10

4.11.1.2 VLAN Configuration

Delete	VLAN ID	Snooping Enabled	Querier Election	Querier Address	Compatibility	PRI	RV	QI (sec)	QRI (0.1 sec)	LLQI (0.1 sec)	URI (sec)
Delete		<input checked="" type="checkbox"/>	<input checked="" type="checkbox"/>	0.0.0.0	IGMP-Auto	0	2	125	100	10	1

This page is used to configure IGMP Snooping for an interface.

Click the “Add New IGMP VLAN” button to add a new entry.

VLAN ID: Specify VLAN ID for IGMP snooping.

Snooping Enabled: Select the checkbox to enable snooping feature on an interface basis. When enabled, the switch will monitor network traffic on the specified interface to determine which hosts want to receive multicast services. If IGMP snooping is enabled globally and an interface’s IGMP snooping is enabled on an interface, IGMP snooping on an interface will take precedence. When disabled, snooping can still be configured on an interface. However, settings will only take effect until IGMP snooping is enabled globally.

Querier Election: Enable to join querier election in the VLAN. When disabled, it will act as an IGMP non-querier.

Querier Address: Specify the IPv4 unicast source address used in IP header for IGMP querier election. When the field is not specified, the switch uses the first available IPv4 management address of the IP interface associated with this VLAN.

Compatibility: This configures how hosts and routers take actions within a network depending on IGMP version selected. Available options are “IGMP-Auto”, “Forced IGMPv1”, “Forced IGMPv2”, “Forced IGMPv3”. By default, IGMP-Auto is used.

PRI: Select the priority of interface. This field indicates the IGMP control frame priority level generated by the system which is used to prioritize different classes of traffic. The allowed range is 0 (best effort) to 7 (highest). By default, interface priority value is set to 0.

RV: The robustness variable (RV) allows tuning for the expected packet loss on a subnet. If a subnet is susceptible to packet loss, this value can be increased. The RV value must not be zero and should not be one. The value should be 2 or greater. By default, it is set to 2.

QI (sec): The Query Interval is the interval between IGMP General Query messages sent by the Querier. The default Querier Interval is 125 seconds.

QRI: The Query Response Interval is the maximum amount of time that the IGMP router waits to receive a response to a General Query message. The QRI applies when the switch is acting as the querier and is used to inform other devices of the maximum time this system waits for a response to general queries. By default, RQI is set to 10 seconds. The allowed range is 0~31744 tenths of a second.

LLQI: The Last Listener Query Interval sets the interval that waits for a response to a group-specific or group-and-source specific query message.

URI: The Unsolicited Report Interval is the amount of time that the upstream interface should transmit unsolicited IGMP reports when report suppression/proxy reporting is enabled. By default, URI is set to 1 second. The allowed range for URI is 0 -31744 seconds.

4.11.1.3 Status

IGMP Snooping Status									
Statistics									
VLAN ID	Querier Version	Host Version	Querier Status	Queries Transmitted	Queries Received	V1 Reports Received	V2 Reports Received	V3 Reports Received	V2 Leaves Received
Router Port									
Port	Status								
1	-								
2	-								
3	-								
4	-								
5	-								
6	-								
7	-								
8	-								
9	-								
10	-								
11	-								
12	-								
13	-								
14	-								
15	-								
16	-								
17	-								
18	-								
19	-								
20	-								

Statistics

VLAN ID: The VLAN ID of this entry.

Querier Version: The current working Querier version.

Host Version: The current host version.

Querier Status: Show the Querier status that is either "ACTIVE" or "IDLE". "DISABLE" denotes the specific interface is administratively disabled.

Queries Transmitted: The number of queries transmitted.

Queries Received: The number of queries received.

V1 Reports Received: The number of Received V1 Reports.

V2 Reports Received: The number of Received V2 Reports.

V3 Reports Received: The number of Received V3 Reports.

V2 Leaves Received: The number of Received V2 Leaves.

Router Port

Port: The port number.

Status: Indicate whether a specific port is a router port or not.

4.11.1.4 Groups Information

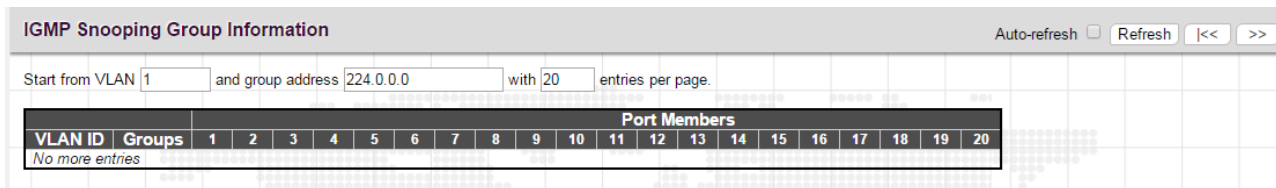

VLAN ID: Display the VLAN ID of the group.

Groups: Display the group address.

Port Members: Ports that belong to this group.

NOTE: The maximum number of IGMP Snooping groups can be learned is 32.

4.11.1.1 Port Filtering Profile

The Port Filtering Configuration page is to filter specific multicast traffic on a per port basis. Before you select a filtering profile for filtering purposes, you must set up profiles in IPMC Profile page.

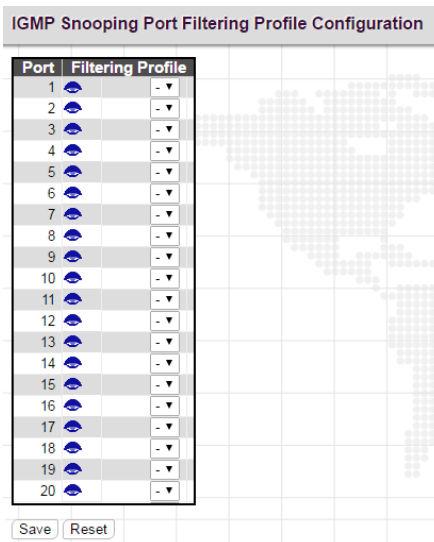

Port: The port number.

Filtering Profile: Select the configured multicast groups that are denied on a port. When a certain multicast group is selected on a port, IGMP join reports received on a port are dropped.

: Click the summary button to view details of the selected IPMC profile.

4.11.1.2 IPv4 SFM Information

IGMP SFM Information						
Start from VLAN <input type="text" value="1"/> and Group <input type="text" value="224.0.0.0"/> with <input type="text" value="20"/> entries per page.						
VLAN ID	Group	Port	Mode	Source Address	Type	Hardware Filter/Switch
No more entries						

VLAN ID: Display the VLAN ID of the group.

Groups: Display the IP address of a multicast group.

Port: The switch port number.

Mode: The filtering mode maintained per VLAN ID, port number and group address.

Source Address: The source IP address available for filtering.

Type: Display either Allow or Deny type.

Hardware Filter/Switch: Indicates whether the data plane destined to the specific group address from the source IPv4 address can be handled by the chip or not.

4.11.2 MLD Snooping

Multicast Listener Discovery (MLD) snooping, similar to IGMP snooping for IPv4, operates on IPv6 for multicast traffic. In other words, MLD snooping configures ports to limit or control IPv6 multicast traffic so that multicast traffic is forwarded to ports (or users) who want to receive it. In this way, MLD snooping can reduce the flooding of IPv6 multicast packets in the specified VLANs. Please note that IGMP Snooping and MLD Snooping are independent of each other. They can both be enabled and function at the same time.

4.11.2.1 Basic Configuration

MLD Snooping Configuration	
Global Configuration	
Snooping Enabled	<input type="checkbox"/>
Unregistered IPMCv6 Flooding Enabled	<input checked="" type="checkbox"/>
MLD SSM Range	<input type="text" value="ff3e::"/> / <input type="text" value="96"/>
Leave Proxy Enabled	<input type="checkbox"/>
Proxy Enabled	<input type="checkbox"/>

Port Related Configuration			
Port	Router Port	Fast Leave	Throttling
*	<input type="checkbox"/>	<input type="checkbox"/>	<>
1	<input type="checkbox"/>	<input type="checkbox"/>	unlimited
2	<input type="checkbox"/>	<input type="checkbox"/>	unlimited
3	<input type="checkbox"/>	<input type="checkbox"/>	unlimited
4	<input type="checkbox"/>	<input type="checkbox"/>	unlimited
5	<input type="checkbox"/>	<input type="checkbox"/>	unlimited
6	<input type="checkbox"/>	<input type="checkbox"/>	unlimited
7	<input type="checkbox"/>	<input type="checkbox"/>	unlimited
8	<input type="checkbox"/>	<input type="checkbox"/>	unlimited
9	<input type="checkbox"/>	<input type="checkbox"/>	unlimited
10	<input type="checkbox"/>	<input type="checkbox"/>	unlimited
11	<input type="checkbox"/>	<input type="checkbox"/>	unlimited
12	<input type="checkbox"/>	<input type="checkbox"/>	unlimited
13	<input type="checkbox"/>	<input type="checkbox"/>	unlimited
14	<input type="checkbox"/>	<input type="checkbox"/>	unlimited
15	<input type="checkbox"/>	<input type="checkbox"/>	unlimited
16	<input type="checkbox"/>	<input type="checkbox"/>	unlimited
17	<input type="checkbox"/>	<input type="checkbox"/>	unlimited
18	<input type="checkbox"/>	<input type="checkbox"/>	unlimited
19	<input type="checkbox"/>	<input type="checkbox"/>	unlimited
20	<input type="checkbox"/>	<input type="checkbox"/>	unlimited

Save Reset

Global Configuration

Snooping Enabled: Select the checkbox to globally enable MLD Snooping feature. When enabled, this device will monitor network traffic and determine which hosts would like to receive multicast traffic. The switch can passively monitor or snoop on MLD Listener Query and Report packets transferred between IP multicast routers and IP multicast service subscribers to identify the multicast group members. The switch simply monitors the IGMP packets passing through it, picks out the group registration information and configures the multicast filters accordingly.

Unregistered IPMCv6 Flooding Enabled: Set forwarding mode for unregistered (not-joined) IP multicast traffic. Select the checkbox to flood traffic.

MLD SSM Range: SSM (Source-Specific Multicast) Range allows the SSM-aware hosts and routers run the SSM service model for the groups in the address range.

Leave Proxy Enabled: To prevent multicast router from becoming overloaded with leave messages, MLD snooping suppresses leave messages unless received from the last member port in the group. When the switch acts as the querier, the leave proxy feature will not function.

Proxy Enabled: When MLD proxy is enabled, the switch exchanges MLD messages with the router on its upstream interface, and performs the host portion of the MLD task on the upstream interface as follows:

- When queried, it sends multicast listener reports to the group.
- When a host joins a multicast group to which no other host belongs, it sends unsolicited multicast listener reports to that group.
- When the last host in a particular multicast group leaves, it sends an unsolicited multicast listener done report to the all-routers address (FF02::2) for MLDv1.

Port Related Configuration

Port: The port number.

Router Port: Tick the checkbox on a given port to assign it as a router port. If MLD snooping cannot locate the MLD

querier, you can manually designate a port which is connected to a known MLD querier (i.e., a multicast router/switch). This interface will then join all the current multicast groups supported by the attached router/switch to ensure that multicast traffic is passed to all appropriate interfaces within the switch.

Fast Leave: Enable fast leave function if the checkbox is ticked. When a leave packet is received, the switch immediately removes it from a multicast service without sending a MLD group-specific (GS) query to that interface.

Throttling: This field limits the maximum number of multicast groups that a port can join at the same time. When the maximum number is reached on a port, any new MLD join reports will be dropped. By default, unlimited is selected. Other allowed options are 1–10.

4.11.2.2 VLAN Configuration

MLD Snooping VLAN Configuration

Start from VLAN with entries per page.

Delete	VLAN ID	Snooping Enabled	Querier Election	Compatibility	PRI	RV	QI (sec)	QRI (0.1 sec)	LLQI (0.1 sec)	URI (sec)
<input type="button" value="Delete"/>		<input type="checkbox"/>	<input checked="" type="checkbox"/>	MLD-Auto	0	2	125	100	10	1

This page is used to configure MLD Snooping for an interface.

VLAN ID: Specify VLAN ID for MLD snooping.

Snooping Enabled: Select the checkbox to enable snooping feature on an interface basis. When enabled, the switch will monitor network traffic on the specified interface to determine which hosts want to receive multicast services.

Querier Election: Enable to join querier election in the VLAN. When enabled, the switch can serve as the MLDv2 querier in the bidding process with other competing multicast routers or switches. Once it becomes querier, it will be responsible for asking hosts periodically if they want to receive multicast traffic. When disabled, it will act as an IGMP non-querier.

Compatibility: This configures how hosts and routers take actions within a network depending on MLD version selected. Available options are “MLD-Auto”, “Forced MLDv1” and “Forced MLDv2”. By default, MLD-Auto is used.

PRI: Select the priority of interface. This field indicates the MLD control frame priority level generated by the system which is used to prioritize different classes of traffic. The allowed range is 0 (best effort) to 7 (highest). By default, interface priority value is set to 0.

RV: The robustness variable (RV) allows tuning for the expected packet loss on a subnet. If a subnet is susceptible to packet loss, this value can be increased. The RV value must not be zero and should not be one. The value should be 2 or greater. By default, it is set to 2. The allowed range is 1–255.

QI (sec): The Query Interval is the interval between IGMP General Query messages sent by the Querier. The default Querier Interval is 125 seconds. The allowed interval range is 1–31744 seconds.

QRI: The Query Response Interval is the maximum amount of time that the IGMP router waits to receive a response to a General Query message. The QRI applies when the switch is acting as the querier and is used to inform other devices of the maximum time this system waits for a response to general queries. By default, RQI is set to 10 seconds. The allowed range is 0–31744 tenths of a second.

LLQI: The Last Listener Query Interval sets the interval that waits for a response to a group-specific or group-and-source specific query message.

URI: The Unsolicited Report Interval is the amount of time that the upstream interface should transmit unsolicited IGMP reports when report suppression/proxy reporting is enabled. By default, URI is set to 1 second. The allowed range for URI is 0~31744 seconds.

Click the “Add New MLD VLAN” button to add a new entry.

4.11.2.3 Port Filtering Profile

The Port Filtering Configuration page is to filter specific multicast traffic on a per port basis. Before you select a filtering profile for filtering purposes, you must set up profiles in IPMC Profile page.

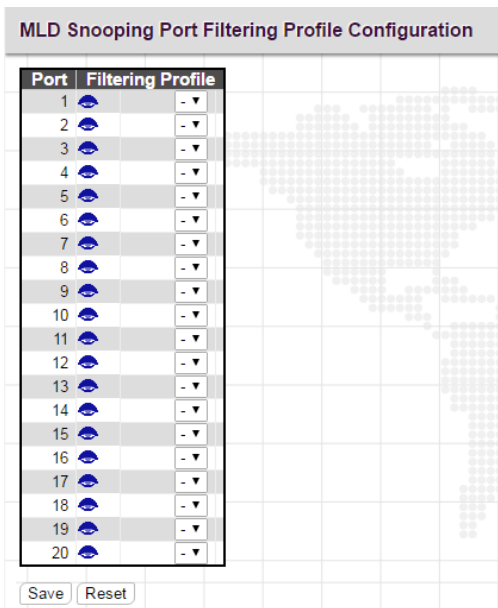

Port: List the number of each port.

Filtering Profile: Select the configured multicast groups that are denied on a port. When a certain multicast group is selected on a port, MLD join reports received on a port are dropped.

: Click the summary button to view details of the selected IPMC profile.

4.11.2.4 Status

MLD Snooping Status								
Statistics								
VLAN ID	Querier Version	Host Version	Querier Status	Queries Transmitted	Queries Received	V1 Reports Received	V2 Reports Received	V1 Leaves Received
Router Port								
Port	Status							
1	-							
2	-							
3	-							
4	-							
5	-							
6	-							
7	-							
8	-							
9	-							
10	-							
11	-							
12	-							
13	-							
14	-							
15	-							
16	-							
17	-							
18	-							
19	-							
20	-							

Statistics

VLAN ID: The VLAN ID of this entry.

Querier Version: The current working Querier version.

Host Version: The current host version.

Querier Status: Show the Querier status that is either "ACTIVE" or "IDLE". "DISABLE" denotes the specific interface is administratively disabled.

Queries Transmitted: The number of queries transmitted.

Queries Received: The number of queries received.

V1 Reports Received: The number of Received V1 Reports.

V2 Reports Received: The number of Received V2 Reports.

V2 Leaves Received: The number of Received V2 Leaves.

Router Port

Port: The port number.

Status: Indicate whether a specific port is a router port or not.

4.11.2.5 Groups Information

MLD Snooping Group Information		Auto-refresh <input type="checkbox"/> Refresh << >>																			
Start from VLAN <input type="text" value="1"/> and group address <input type="text" value="ff00::"/> with <input type="text" value="20"/> entries per page.																					
VLAN ID	Groups	1	2	3	4	5	6	7	8	9	10	11	12	13	14	15	16	17	18	19	20
No more entries																					

VLAN ID: Display the VLAN ID of the group.

Groups: Display the group address.

Port Members: Ports that belong to this group.

NOTE: The maximum number of MLD Snooping groups can be learned is 32.

4.11.2.6 IPv6 SFM Information

MLD SFM Information						
Start from VLAN <input type="text" value="1"/> and Group <input type="text" value="ff00::"/> with <input type="text" value="20"/> entries per page.						
VLAN ID	Group	Port	Mode	Source Address	Type	Hardware Filter/Switch
No more entries						

VLAN ID: Display the VLAN ID of the group.

Group: Display the IP address of a multicast group.

Port: The switch port number.

Mode: The filtering mode maintained per VLAN ID, port number and group address.

Source Address: The source IP address available for filtering.

Type: Display either Allow or Deny type.

Hardware Filter/Switch: Indicates whether the data plane destined to the specific group address from the source IPv4 address can be handled by the chip or not.

4.12 LLDP

LLDP (Link Layer Discovery Protocol) runs over data link layer which is used for network devices to send information about themselves to other directly connected devices on the network. By using LLDP, two devices running different network layer protocols can learn information about each other. A set of attributes referred to TLVs are used to discover neighbour devices. Details such as port description, system name, system description, system capabilities, management address can be sent and received on this device.

The “LLDP” menu contains the following sub menus. Select the appropriate menu to set up detailed configurations.



4.12.1 Configuration

LLDP Configuration

LLDP Parameters

Tx Interval	<input type="text" value="30"/>	seconds
Tx Hold	<input type="text" value="4"/>	times
Tx Delay	<input type="text" value="2"/>	seconds
Tx Reinit	<input type="text" value="2"/>	seconds

LLDP Interface Configuration

Port	Mode	CDP aware	Trap	Optional TLVs				
				Port Descr	Sys Name	Sys Descr	Sys Capa	Mgmt Addr
*	<>	<input type="checkbox"/>	<input type="checkbox"/>	<input checked="" type="checkbox"/>	<input checked="" type="checkbox"/>	<input checked="" type="checkbox"/>	<input checked="" type="checkbox"/>	<input checked="" type="checkbox"/>
1	Enabled	<input type="checkbox"/>	<input type="checkbox"/>	<input checked="" type="checkbox"/>	<input checked="" type="checkbox"/>	<input checked="" type="checkbox"/>	<input checked="" type="checkbox"/>	<input checked="" type="checkbox"/>
2	Enabled	<input type="checkbox"/>	<input type="checkbox"/>	<input checked="" type="checkbox"/>	<input checked="" type="checkbox"/>	<input checked="" type="checkbox"/>	<input checked="" type="checkbox"/>	<input checked="" type="checkbox"/>
3	Enabled	<input type="checkbox"/>	<input type="checkbox"/>	<input checked="" type="checkbox"/>	<input checked="" type="checkbox"/>	<input checked="" type="checkbox"/>	<input checked="" type="checkbox"/>	<input checked="" type="checkbox"/>
4	Enabled	<input type="checkbox"/>	<input type="checkbox"/>	<input checked="" type="checkbox"/>	<input checked="" type="checkbox"/>	<input checked="" type="checkbox"/>	<input checked="" type="checkbox"/>	<input checked="" type="checkbox"/>
5	Enabled	<input type="checkbox"/>	<input type="checkbox"/>	<input checked="" type="checkbox"/>	<input checked="" type="checkbox"/>	<input checked="" type="checkbox"/>	<input checked="" type="checkbox"/>	<input checked="" type="checkbox"/>
6	Enabled	<input type="checkbox"/>	<input type="checkbox"/>	<input checked="" type="checkbox"/>	<input checked="" type="checkbox"/>	<input checked="" type="checkbox"/>	<input checked="" type="checkbox"/>	<input checked="" type="checkbox"/>
7	Enabled	<input type="checkbox"/>	<input type="checkbox"/>	<input checked="" type="checkbox"/>	<input checked="" type="checkbox"/>	<input checked="" type="checkbox"/>	<input checked="" type="checkbox"/>	<input checked="" type="checkbox"/>
8	Enabled	<input type="checkbox"/>	<input type="checkbox"/>	<input checked="" type="checkbox"/>	<input checked="" type="checkbox"/>	<input checked="" type="checkbox"/>	<input checked="" type="checkbox"/>	<input checked="" type="checkbox"/>
9	Enabled	<input type="checkbox"/>	<input type="checkbox"/>	<input checked="" type="checkbox"/>	<input checked="" type="checkbox"/>	<input checked="" type="checkbox"/>	<input checked="" type="checkbox"/>	<input checked="" type="checkbox"/>
10	Enabled	<input type="checkbox"/>	<input type="checkbox"/>	<input checked="" type="checkbox"/>	<input checked="" type="checkbox"/>	<input checked="" type="checkbox"/>	<input checked="" type="checkbox"/>	<input checked="" type="checkbox"/>
11	Enabled	<input type="checkbox"/>	<input type="checkbox"/>	<input checked="" type="checkbox"/>	<input checked="" type="checkbox"/>	<input checked="" type="checkbox"/>	<input checked="" type="checkbox"/>	<input checked="" type="checkbox"/>
12	Enabled	<input type="checkbox"/>	<input type="checkbox"/>	<input checked="" type="checkbox"/>	<input checked="" type="checkbox"/>	<input checked="" type="checkbox"/>	<input checked="" type="checkbox"/>	<input checked="" type="checkbox"/>
13	Enabled	<input type="checkbox"/>	<input type="checkbox"/>	<input checked="" type="checkbox"/>	<input checked="" type="checkbox"/>	<input checked="" type="checkbox"/>	<input checked="" type="checkbox"/>	<input checked="" type="checkbox"/>
14	Enabled	<input type="checkbox"/>	<input type="checkbox"/>	<input checked="" type="checkbox"/>	<input checked="" type="checkbox"/>	<input checked="" type="checkbox"/>	<input checked="" type="checkbox"/>	<input checked="" type="checkbox"/>
15	Enabled	<input type="checkbox"/>	<input type="checkbox"/>	<input checked="" type="checkbox"/>	<input checked="" type="checkbox"/>	<input checked="" type="checkbox"/>	<input checked="" type="checkbox"/>	<input checked="" type="checkbox"/>
16	Enabled	<input type="checkbox"/>	<input type="checkbox"/>	<input checked="" type="checkbox"/>	<input checked="" type="checkbox"/>	<input checked="" type="checkbox"/>	<input checked="" type="checkbox"/>	<input checked="" type="checkbox"/>
17	Enabled	<input type="checkbox"/>	<input type="checkbox"/>	<input checked="" type="checkbox"/>	<input checked="" type="checkbox"/>	<input checked="" type="checkbox"/>	<input checked="" type="checkbox"/>	<input checked="" type="checkbox"/>
18	Enabled	<input type="checkbox"/>	<input type="checkbox"/>	<input checked="" type="checkbox"/>	<input checked="" type="checkbox"/>	<input checked="" type="checkbox"/>	<input checked="" type="checkbox"/>	<input checked="" type="checkbox"/>
19	Enabled	<input type="checkbox"/>	<input type="checkbox"/>	<input checked="" type="checkbox"/>	<input checked="" type="checkbox"/>	<input checked="" type="checkbox"/>	<input checked="" type="checkbox"/>	<input checked="" type="checkbox"/>
20	Enabled	<input type="checkbox"/>	<input type="checkbox"/>	<input checked="" type="checkbox"/>	<input checked="" type="checkbox"/>	<input checked="" type="checkbox"/>	<input checked="" type="checkbox"/>	<input checked="" type="checkbox"/>

LLDP Parameters

Tx Interval: Specify the interval between LLDP frames are sent to its neighbours for updated discovery information. The valid values are 5 - 32768 seconds. The default is 30 seconds.

Tx Hold: This setting defines how long LLDP frames are considered valid and is used to compute the TTL. Valid range is 2~10 times. The default is 4.

Tx Delay: Specify a delay between the LLDP frames that contain changed configurations. Tx Delay cannot be larger than 1/4 of the Tx interval value. The valid values are 1 - 8192 seconds.

Tx Reinit: Specify a delay between the shutdown frame and a new LLDP initialization. The valid values are 1~10 seconds.

LLDP Port Configuration

Port: The port number. "Port *" settings apply to all ports.

Mode: Select the appropriate LLDP mode.

Disabled: LLDP information will not be sent and LLDP information received from neighbours will be dropped.

Enabled: LLDP information will be sent and LLDP information received from neighbours will be analyzed.

Rx Only: The switch will analyze LLDP information received from neighbours.

Tx Only: The switch will send out LLDP information but will drop LLDP information received from neighbours.

CDP Aware: CDP aware operation is used to decode incoming CDP (Cisco Discovery Protocol) frames. If enabled, CDP TLVs that can be mapped into a corresponding field in the LLDP neighbors table are decoded, all others are discarded. CDP TLVs are mapped into LLDP neighbors table as shown below:

Optional TLVs: LLDP uses several attributes to discover neighbour devices. These attributes contains type, length, and value descriptions and are referred to TLVs. Details such as port description, system name, system description, system capabilities, management address can be sent from this device. Uncheck the boxes if they are not appropriate to be known by other neighbour devices.

4.12.2 Neighbours

LLDP Neighbour Information						
LLDP Remote Device Summary						
Local Port	Chassis ID	Port ID	Port Description	System Name	System Capabilities	Management Address
No neighbour information found						

Local Port: The local port that a remote LLDP-capable device is attached.

Chassis ID: An ID indicating the particular chassis in this system.

Port ID: A remote port ID that LDPDUs were transmitted.

Port Description: A remote port's description.

System Name: The system name assigned to the remote system.

System Capabilities: This shows the neighbour unit’s capabilities. When a capability is enabled, the capability is followed by (+). If disabled, the capability is followed by (-).

Management Address: The IPv4 address of the remote device. If no management address is available, the address should be the MAC address for the CPU or for the port sending this advertisement. If the neighbor device allows management access, clicking on an entry in this field will re-direct the web browser to the neighbor’s management interface.

4.12.3 LLDP-MED

LLDP for Media Endpoint Devices (LLDP-MED) is an extension to LLDP that operates between endpoint devices such as IP phones and network devices such as switches. It specifically provides support for voice over IP (VoIP) applications and provides additional TLVs for capabilities discovery, network policy, Power over Ethernet, inventory management and location information.

LLDP-MED Configuration

Fast Start Repeat Count

Fast start repeat count

LLDP-MED Interface Configuration

Port	Transmit TLVs				Device Type
	Capabilities	Policies	Location	PoE	
*	<input checked="" type="checkbox"/>	<input checked="" type="checkbox"/>	<input checked="" type="checkbox"/>	<input checked="" type="checkbox"/>	<>
1	<input checked="" type="checkbox"/>	<input checked="" type="checkbox"/>	<input checked="" type="checkbox"/>	<input checked="" type="checkbox"/>	Connectivity
2	<input checked="" type="checkbox"/>	<input checked="" type="checkbox"/>	<input checked="" type="checkbox"/>	<input checked="" type="checkbox"/>	Connectivity
3	<input checked="" type="checkbox"/>	<input checked="" type="checkbox"/>	<input checked="" type="checkbox"/>	<input checked="" type="checkbox"/>	Connectivity
4	<input checked="" type="checkbox"/>	<input checked="" type="checkbox"/>	<input checked="" type="checkbox"/>	<input checked="" type="checkbox"/>	Connectivity
5	<input checked="" type="checkbox"/>	<input checked="" type="checkbox"/>	<input checked="" type="checkbox"/>	<input checked="" type="checkbox"/>	Connectivity
6	<input checked="" type="checkbox"/>	<input checked="" type="checkbox"/>	<input checked="" type="checkbox"/>	<input checked="" type="checkbox"/>	Connectivity
7	<input checked="" type="checkbox"/>	<input checked="" type="checkbox"/>	<input checked="" type="checkbox"/>	<input checked="" type="checkbox"/>	Connectivity
8	<input checked="" type="checkbox"/>	<input checked="" type="checkbox"/>	<input checked="" type="checkbox"/>	<input checked="" type="checkbox"/>	Connectivity
9	<input checked="" type="checkbox"/>	<input checked="" type="checkbox"/>	<input checked="" type="checkbox"/>	<input checked="" type="checkbox"/>	Connectivity
10	<input checked="" type="checkbox"/>	<input checked="" type="checkbox"/>	<input checked="" type="checkbox"/>	<input checked="" type="checkbox"/>	Connectivity
11	<input checked="" type="checkbox"/>	<input checked="" type="checkbox"/>	<input checked="" type="checkbox"/>	<input checked="" type="checkbox"/>	Connectivity
12	<input checked="" type="checkbox"/>	<input checked="" type="checkbox"/>	<input checked="" type="checkbox"/>	<input checked="" type="checkbox"/>	Connectivity
13	<input checked="" type="checkbox"/>	<input checked="" type="checkbox"/>	<input checked="" type="checkbox"/>	<input checked="" type="checkbox"/>	Connectivity
14	<input checked="" type="checkbox"/>	<input checked="" type="checkbox"/>	<input checked="" type="checkbox"/>	<input checked="" type="checkbox"/>	Connectivity
15	<input checked="" type="checkbox"/>	<input checked="" type="checkbox"/>	<input checked="" type="checkbox"/>	<input checked="" type="checkbox"/>	Connectivity
16	<input checked="" type="checkbox"/>	<input checked="" type="checkbox"/>	<input checked="" type="checkbox"/>	<input checked="" type="checkbox"/>	Connectivity
17	<input checked="" type="checkbox"/>	<input checked="" type="checkbox"/>	<input checked="" type="checkbox"/>	<input checked="" type="checkbox"/>	Connectivity
18	<input checked="" type="checkbox"/>	<input checked="" type="checkbox"/>	<input checked="" type="checkbox"/>	<input checked="" type="checkbox"/>	Connectivity
19	<input checked="" type="checkbox"/>	<input checked="" type="checkbox"/>	<input checked="" type="checkbox"/>	<input checked="" type="checkbox"/>	Connectivity
20	<input checked="" type="checkbox"/>	<input checked="" type="checkbox"/>	<input checked="" type="checkbox"/>	<input checked="" type="checkbox"/>	Connectivity

Coordinates Location

Latitude ° Longitude ° Altitude Meters Map Datum

Civic Address Location

Country code	State	County
City	City district	Block (Neighbourhood)
Street	Leading street direction	Trailing street suffix
Street suffix	House no.	House no. suffix
Landmark	Additional location info	Name
Zip code	Building	Apartment
Floor	Room no.	Place type
Postal community name	P.O. Box	Additional code

Emergency Call Service

Emergency Call Service

Policies

Delete	Policy ID	Application Type	Tag	VLAN ID	L2 Priority	DSCP
No entries present						

Fast Start Repeat Count: Rapid startup and Emergency Call Service Location Identification Discovery of endpoints is a critically important aspect of VoIP systems in general. In addition, it is best to advertise only those pieces of information which are specifically relevant to particular endpoint types (for example only advertise the voice network policy to permitted voice-capable devices), both in order to conserve the limited LLDP space and to reduce security and system integrity issues that can come with inappropriate knowledge of the network policy. With this in mind, LLDP-MED defines an LLDP-MED Fast Start interaction between the protocol and the application layers on top of the protocol, in order to achieve these related properties. With Fast start repeat count it is possible to specify the number of times the fast start transmission is repeated. The recommended value is 4 times, giving that 4 LLDP frames with a 1 second interval will be transmitted, when a LLDP frame with new information is received. It should be noted that LLDP-MED and the LLDP-MED Fast Start mechanism is only intended to run on links between LLDP-MED Network Connectivity Devices and Endpoint Devices, and as such does not apply to links between LAN infrastructure elements, including between Network Connectivity Devices, or to other types of links.

LLDP-MED Interface Configuration

Transmit TLVs: Check the items (Capabilities, Policies, Location, PoE) that you want to include in LLDP-MED information transmitted.

Device Type: Any LLDP device can operate as a specific type of LLDP-MED device, which may be either a network connectivity device or a specific class of end-point device.

Connectivity: A Network Connectivity Device is a LLDP-MED Device that provides access to the IEEE 802 based LAN infrastructure for LLDP-MED Endpoint Devices

An LLDP-MED Network Connectivity Device is a LAN access device based on any of the following technologies :

1. LAN Switch/Router
2. IEEE 802.1 Bridge
3. IEEE 802.3 Repeater (included for historical reasons)
4. IEEE 802.11 Wireless Access Point
5. Any device that supports the IEEE 802.1AB and MED extensions that can relay IEEE 802 frames via any method.

End-Point: An LLDP-MED Endpoint Device sits at the network edge and provides some aspect of IP communications service, based on IEEE 802 LAN technology.

The main difference between a Network Connectivity Device and an Endpoint Device is that only an Endpoint Device can start the LLDP-MED information exchange.

Even though a switch always should be a Network Connectivity Device, it is possible to configure it to act as an Endpoint Device, and thereby start the LLDP-MED information exchange (In the case where two Network Connectivity Devices are connected together)

Coordinates Location

Latitude: Latitude SHOULD be normalized to within 0-90 degrees with a maximum of 4 digits. It is possible to specify the direction to either North of the equator or South of the equator.

Longitude: Longitude SHOULD be normalized to within 0-180 degrees with a maximum of 4 digits. It is possible to specify the direction to either East of the prime meridian or West of the prime meridian.

Altitude: Altitude SHOULD be normalized to within -32767 to 32767 with a maximum of 4 digits. It is possible to select between two altitude types (floors or meters).

Meters: Representing meters of Altitude defined by the vertical datum specified.

Floors: Representing altitude in a form more relevant in buildings which have different floor-to-floor dimensions. An altitude = 0.0 is meaningful even outside a building, and represents ground level at the given latitude and longitude. Inside a building, 0.0 represents the floor level associated with ground level at the main entrance.

Map Datum: The Map Datum is used for the coordinates given in these options:

WGS84: (Geographical 3D) - World Geodesic System 1984, CRS Code 4327, Prime Meridian Name: Greenwich.

NAD83/NAVD88: North American Datum 1983, CRS Code 4269, Prime Meridian Name: Greenwich; The associated vertical datum is the North American Vertical Datum of 1988 (NAVD88). This datum pair is to be used when referencing locations on land, not near tidal water (which would use Datum = NAD83/MLLW).

NAD83/MLLW: North American Datum 1983, CRS Code 4269, Prime Meridian Name: Greenwich; The associated vertical datum is Mean Lower Low Water (MLLW). This datum pair is to be used when referencing locations on water/sea/ocean.

Civic Address Location

IETF Geopriv Civic Address based Location Configuration Information (Civic Address LCI).

Country Code: The two-letter ISO 3166 country code in capital ASCII letters - Example: DK, DE or US.

State: National subdivisions (state, canton, region, province, prefecture).

County: County, parish, gun (Japan), district.

City: City, township, shi (Japan) - Example: Copenhagen.

City District: City division, borough, city district, ward, chou (Japan).

Block (Neighbourhood): Neighbourhood, block.

Street: Street - Example: Poppelvej.

Leading street direction: Example: N.

Trailing street suffix: Example: SW.

Street suffix: Example: Ave, Platz.

House no.: Example: 21.

House no. suffix: Example: A, 1/2.

Landmark: Landmark or vanity address - Example: Columbia University.

Additional location info: Example: South Wing.

Name: Name (residence and office occupant): Example: Flemming Jahn.

Zip code: Postal/zip code - Example: 2791.

Building: Building (structure). Example: Low Library.

Apartment: Unit (Apartment, suite). Example: Apt 42.

Floor: Example: 4.

Room no.: Room number - Example: 450F.

Place type: Example: Office.

Postal community name: Example: Leonia.

P.O. Box: Example: 12345.

Additional code: Example: 1320300003.

Emergency Call Service

Emergency Call Service: Emergency Call Service (e.g. E911 and others), such as defined by TIA or NENA.

Policies

Policy ID: Specify the ID for this policy.

Application Type: The application types include “Voice”, “Voice Signalling”, “Guest Voice”, “Guest Voice Signalling”, “Softphone Voice”, “Video Conferencing”, “Streaming”, “Video Signalling”.

Tag: Tag indicating whether the specified application type is using a “tagged” or an “untagged” VLAN.

VLAN ID: Specify the VLAN ID for the port.

L2 Priority: Specify one of eight priority levels (0-7) as defined by 802.1D-2004.

DSCP: Specify one of 64 code point values (0-63) as defined in IETF RFC 2474.

4.12.4 LLDP-MED Neighbours

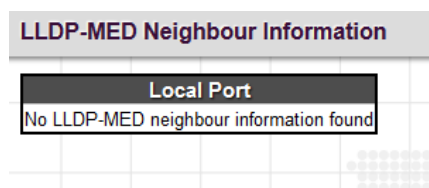

LLDP-MED Neighbour Information	
Local Port	
	No LLDP-MED neighbour information found

This page displays information about LLDP-MED neighbours detected on the network.

4.12.5 PoE

This status page provides a status overview for all LLDP PoE neighbors.

LLDP Neighbor Power Over Ethernet Information				
Local Interface	Power Type	Power Source	Power Priority	Maximum Power
No PoE neighbor information found				

Local Interface: The interface for this switch on which the LLDP frame was received.

Power Type: This field shows whether the device is a Power Sourcing Entity (PSE) or Power Device (PD). If the Power Type is unknown it is represented as "Reserved".

Power Source: The Power Source represents the power source being utilized by a PSE or PD device.

If the device is a PSE device it can either run on its Primary Power Source or its Backup Power Source. If it is unknown whether the PSE device is using its Primary Power Source or its Backup Power Source it is indicated as "Unknown"

If the device is a PD device it can either run on its local power supply or it can use the PSE as power source. It can also use both its local power supply and the PSE.

If it is unknown what power supply the PD device is using it is indicated as "Unknown"

Power Priority: Power Priority represents the priority of the PD device, or the power priority associated with the PSE type device's interface that is sourcing the power. There are three levels of power priority. The three levels are: Critical, High and Low. If the power priority is unknown it is indicated as "Unknown".

Maximum Power: The Maximum Power Value contains a numerical value that indicates the maximum power in watts required by a PD device from a PSE device, or the minimum power a PSE device is capable of sourcing over a maximum length cable based on its current configuration.

4.12.6 LLDP EEE

LLDP Neighbors EEE Information								
Local Port	Tx Tw	Rx Tw	Fallback Receive Tw	Echo Tx Tw	Echo Rx Tw	Resolved Tx Tw	Resolved Rx Tw	EEE in Sync
No LLDP EEE information found								

Local Port: The port for this switch on which the LLDP frame was received.

Tx Tw: The link partner's maximum time that transmit path can hold-off sending data after deassertion of LPI.

Rx Tw: The link partner's time that receiver would like the transmitter to hold-off to allow time for the receiver to wake from sleep.

Fallback Receive Tw: The link partner's fallback receive Tw.

Echo Tx Tw: The link partner's Echo Tx Tw value. The respective echo values shall be defined as the local link partners reflection (echo) of the remote link partners respective values. When a local link partner receives its echoed values from the remote link partner it can determine whether or not the remote link partner has received, registered and processed its most recent values. For example, if the local link partner receives echoed parameters that do not match the values in its local MIB, then the local link partner infers that the remote link partners request was based on stale information.

Echo Rx Tw: The link partner's Echo Rx Tw value.

Resolved Tx Tw: The resolved Tx Tw for this link.

Resolved Rx Tw: The resolved Rx Tw for this link.

EEE in Sync: This shows whether the switch and the link partner have agreed on wake times.

Red: Switch and link partner have not agreed on wakeup times.

Green: Switch and link partner have agreed on wakeup times.

4.12.7 LLDP Global Counters

LLDP Global Counters									
Global Counters									
Clear global counters <input checked="" type="checkbox"/>									
Neighbor entries were last changed 1970-01-01T00:00:00+00:00 (11479 secs. ago)									
Total Neighbors Entries Added 0									
Total Neighbors Entries Deleted 0									
Total Neighbors Entries Dropped 0									
Total Neighbors Entries Aged Out 0									
LLDP Statistics Local Counters									
Local Port	Tx Frames	Rx Frames	Rx Errors	Frames Discarded	TLVs Discarded	TLVs Unrecognized	Org. Discarded	Age-Outs	Clear
*	*	*	*	*	*	*	*	*	<input checked="" type="checkbox"/>
1	0	0	0	0	0	0	0	0	<input checked="" type="checkbox"/>
2	0	0	0	0	0	0	0	0	<input checked="" type="checkbox"/>
3	0	0	0	0	0	0	0	0	<input checked="" type="checkbox"/>
4	0	0	0	0	0	0	0	0	<input checked="" type="checkbox"/>
5	0	0	0	0	0	0	0	0	<input checked="" type="checkbox"/>
6	0	0	0	0	0	0	0	0	<input checked="" type="checkbox"/>
7	0	0	0	0	0	0	0	0	<input checked="" type="checkbox"/>
8	0	0	0	0	0	0	0	0	<input checked="" type="checkbox"/>
9	0	0	0	0	0	0	0	0	<input checked="" type="checkbox"/>
10	0	0	0	0	0	0	0	0	<input checked="" type="checkbox"/>
11	0	0	0	0	0	0	0	0	<input checked="" type="checkbox"/>
12	0	0	0	0	0	0	0	0	<input checked="" type="checkbox"/>
13	0	0	0	0	0	0	0	0	<input checked="" type="checkbox"/>
14	0	0	0	0	0	0	0	0	<input checked="" type="checkbox"/>
15	0	0	0	0	0	0	0	0	<input checked="" type="checkbox"/>
16	55	0	0	0	0	0	0	0	<input checked="" type="checkbox"/>
17	0	0	0	0	0	0	0	0	<input checked="" type="checkbox"/>
18	0	0	0	0	0	0	0	0	<input checked="" type="checkbox"/>
19	0	0	0	0	0	0	0	0	<input checked="" type="checkbox"/>
20	0	0	0	0	0	0	0	0	<input checked="" type="checkbox"/>

Global Counters

Total Neighbours Entries Added: Shows the number of new entries added since the switch was rebooted, and for which the remote TTL has not yet expired.

Total Neighbors Entries Deleted: The number of LLDP neighbors which have been removed from the LLDP remote systems MIB for any reason.

Total Neighbors Entries Dropped: The number of times which the remote database on this switch dropped an LLDPDU because the entry table was full.

Total Neighbors Entries Aged Out: The number of times that a neighbor’s information has been deleted from the LLDP remote systems MIB because the remote TTL timer has expired.

LLDP Statistics Local Counters

Local Port: The port number.

Tx Frames: The number of LLDP PDUs transmitted.

Rx Frames: The number of LLDP PDUs received.

Rx Errors: The number of received LLDP frames with some kind of error.

Frames Discarded: The number of frames discarded because they did not conform to the general validation rules as well as any specific usage rules defined for the particular Type Length Value (TLV).

TLVs Discarded: Each LLDP frame can contain multiple pieces of information, known as TLVs. If a TLV is malformed, it is counted and discarded.

TLVs Unrecognized: The number of well-formed TLVs, but with an unknown type value.

Org. Discarded: The number of organizational TLVs discarded.

Age-Outs: Each LLDP frame contains information about how long the LLDP information is valid (age-out time). If no new LLDP frame is received within the age-out time, the LLDP information is removed, and the Age-Out counter is incremented.

4.13 PoE (For PoE Models Only)

Power over Ethernet (PoE) configuration page is used to set the maximum PoE power provided to a port, the maximum power budget for the switch (power available to RJ-45 port 9~16), the port PoE operating mode, power allocation priority, and the maximum power allocated to each port. If the power demand from devices connected to the switch exceeds the power budget, the switch uses port power priority settings to limit the supplied power.

The “PoE” menu contains the following sub menus. Select the appropriate menu to configure the detailed settings.

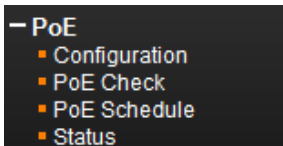

4.13.1 PoE Configuration

Power over Ethernet Configuration

System Configuration

Power Supply: 480 W
Capacitor Detection: Disabled

Port Configuration

Port	Mode	Priority	LLDP
*	<>	<>	<>
1	disable	low	enable
2	disable	low	enable
3	disable	low	enable
4	disable	low	enable
5	disable	low	enable
6	disable	low	enable
7	disable	low	enable
8	disable	low	enable
9	disable	low	enable
10	disable	low	enable
11	disable	low	enable
12	disable	low	enable
13	disable	low	enable
14	disable	low	enable
15	disable	low	enable
16	disable	low	enable

Save Reset

System Configuration

Power Supply [W]: The power budget for the switch. If PDs require more power than the switch’s budge, the port priority settings are used to control the supplied.

Capacitor Detection: Enable or disable capacitor detection function.

PoE Port Configuration

Port: The port number. “Port *” rule applies to all ports.

PoE Mode: PoE operating modes include the following options:

Disabled: Disable PoE function on a per port basis.

Standard: Enable IEEE 802.3af (Class 4 PDs limited to 15.4W).

PoE+: Enable IEEE 802.3at (Class 4 PDs limited to 30W).

Priority: When ports or attached PDs requested more power than the power supply can provide, ports are shut down based on their priority level. The switch will start from shutting down ports that have the low priority and the highest port number.

LLDP: This field configures the port behavior with respect to LLDP.

Enable: PoE parameters received through LLDP are processed.

Disable: PoE parameters received through LLDP are ignored.

4.13.2 PD Monitor

PD Monitor Configuration						
Port	Enable	PD Address	Interval	Retry	Action	Waiting Time
*	<input type="checkbox"/>	0.0.0.0	10	3	<>	60
1	<input type="checkbox"/>	0.0.0.0	10	3	No action	60
2	<input type="checkbox"/>	0.0.0.0	10	3	No action	60
3	<input type="checkbox"/>	0.0.0.0	10	3	No action	60
4	<input type="checkbox"/>	0.0.0.0	10	3	No action	60
5	<input type="checkbox"/>	0.0.0.0	10	3	No action	60
6	<input type="checkbox"/>	0.0.0.0	10	3	No action	60
7	<input type="checkbox"/>	0.0.0.0	10	3	No action	60
8	<input type="checkbox"/>	0.0.0.0	10	3	No action	60
9	<input type="checkbox"/>	0.0.0.0	10	3	No action	60
10	<input type="checkbox"/>	0.0.0.0	10	3	No action	60
11	<input type="checkbox"/>	0.0.0.0	10	3	No action	60
12	<input type="checkbox"/>	0.0.0.0	10	3	No action	60
13	<input type="checkbox"/>	0.0.0.0	10	3	No action	60
14	<input type="checkbox"/>	0.0.0.0	10	3	No action	60
15	<input type="checkbox"/>	0.0.0.0	10	3	No action	60
16	<input type="checkbox"/>	0.0.0.0	10	3	No action	60

Save Reset

Port: The port number. "Port *" rule applies to all ports.

Enable: Select the checkbox on a port to enable PD Monitor function.

PD Address: Specify the PD's IP address for ping purposes. Both IPv4 and IPv6 IP addresses are supported.

Check Interval (5~300 Seconds): Specify the interval between each ping checking.

Retry (Cycles 1~10): Specify the total retry times of IP checking.

Action: If PDs fails to respond ping requests sent by the switch (PSE), then the switch (PSE) can take an appropriate action selected here.

No Action: The switch (PSE) will not take any actions on the PD.

Reboot PD: The switch (PSE) reboots the PD after the PD failure check.

Power Off PD: The switch (PSE) turns off the PD after the PD failure check.

Waiting Time: This is the waiting period while the PD is still in start up process and is unable to work. The allowed range is 30~300 seconds.

4.13.3 PoE Schedule

PSE Schedule Configuration Port 1

Schedule Mode:

Workday	Enable	Start Time	End Time
*	<input type="checkbox"/>	<>	<>
Mon	<input type="checkbox"/>	00:00	00:00
Tue	<input type="checkbox"/>	00:00	00:00
Wed	<input type="checkbox"/>	00:00	00:00
Thu	<input type="checkbox"/>	00:00	00:00
Fri	<input type="checkbox"/>	00:00	00:00
Sat	<input type="checkbox"/>	00:00	00:00
Sun	<input type="checkbox"/>	00:00	00:00

Save Reset

In some working environments, PDs only work for a limited of time. Therefore, PoE schedule mechanism can be used to plan PoE schedule on a per port basis so as to ease the PSE’s power burden.

Configure Port#: Select a port to configure its associated PoE schedule settings.

Schedule Mode: Enable or disable PoE schedule mode.

Weekday: List of weekdays.

Day Enable: Tick on days that you would like the PD to receive power from the PSE.

Start Time: Select the starting time for the PSE to provide power to the PD.

End Time: Select the end time for the PSE to stop providing power to the PD.

4.13.4 Status

Power Over Ethernet Status								Auto-refresh <input type="checkbox"/>	Refresh
Port	PD Class	Power Requested	Power Allocated	Power Used	Current Used	Priority	Port Status		
1	-	0 [W]	0 [W]	0 [W]	0 [mA]	Low	Disabled		
2	-	0 [W]	0 [W]	0 [W]	0 [mA]	Low	Disabled		
3	-	0 [W]	0 [W]	0 [W]	0 [mA]	Low	Disabled		
4	-	0 [W]	0 [W]	0 [W]	0 [mA]	Low	Disabled		
5	-	0 [W]	0 [W]	0 [W]	0 [mA]	Low	Disabled		
6	-	0 [W]	0 [W]	0 [W]	0 [mA]	Low	Disabled		
7	-	0 [W]	0 [W]	0 [W]	0 [mA]	Low	Disabled		
8	-	0 [W]	0 [W]	0 [W]	0 [mA]	Low	Disabled		
9	-	0 [W]	0 [W]	0 [W]	0 [mA]	Low	Disabled		
10	-	0 [W]	0 [W]	0 [W]	0 [mA]	Low	Disabled		
11	-	0 [W]	0 [W]	0 [W]	0 [mA]	Low	Disabled		
12	-	0 [W]	0 [W]	0 [W]	0 [mA]	Low	Disabled		
13	-	0 [W]	0 [W]	0 [W]	0 [mA]	Low	Disabled		
14	-	0 [W]	0 [W]	0 [W]	0 [mA]	Low	Disabled		
15	-	0 [W]	0 [W]	0 [W]	0 [mA]	Low	Disabled		
16	-	0 [W]	0 [W]	0 [W]	0 [mA]	Low	Disabled		
Total		0 [W]	0 [W]	0 [W]	0 [mA]				

Local Port: The port number on this switch that provides PoE function.

PD class: Each PD is classified according to the maximum power it will use. The PD classes include:

- Class 0: Max. power 15.4 W
- Class 1: Max. power 4.0 W
- Class 2: Max. power 7.0 W
- Class 3: Max. power 15.4 W
- Class 4: Max. power 30.0 W

Power Requested: The amount of power that the PDs wants to be reserved.

Power Allocated: The amount of power the switch has allocated for the PD.

Power Used: How much power the PD is currently using.

Current Used: How much current the PD is currently using.

Priority: The port's configured priority level.

Port Status: PoE service status for the attached device.

4.14 MAC Table

The “MAC Table” menu contains configuration and status sub menu. Select the configuration page to set up detailed configuration

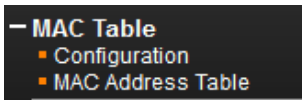

4.14.1 MAC Address Table Configuration

MAC Address Table Configuration

Aging Configuration

Disable Automatic Aging

Aging Time seconds

MAC Table Learning

	Port Members																			
	1	2	3	4	5	6	7	8	9	10	11	12	13	14	15	16	17	18	19	20
Auto	<input checked="" type="radio"/>	<input checked="" type="radio"/>	<input checked="" type="radio"/>	<input checked="" type="radio"/>	<input checked="" type="radio"/>	<input checked="" type="radio"/>	<input checked="" type="radio"/>	<input checked="" type="radio"/>	<input checked="" type="radio"/>	<input checked="" type="radio"/>	<input checked="" type="radio"/>	<input checked="" type="radio"/>	<input checked="" type="radio"/>	<input checked="" type="radio"/>	<input checked="" type="radio"/>	<input checked="" type="radio"/>	<input checked="" type="radio"/>	<input checked="" type="radio"/>	<input checked="" type="radio"/>	<input checked="" type="radio"/>
Disable	<input type="radio"/>	<input type="radio"/>	<input type="radio"/>	<input type="radio"/>	<input type="radio"/>	<input type="radio"/>	<input type="radio"/>	<input type="radio"/>	<input type="radio"/>	<input type="radio"/>	<input type="radio"/>	<input type="radio"/>	<input type="radio"/>	<input type="radio"/>	<input type="radio"/>	<input type="radio"/>	<input type="radio"/>	<input type="radio"/>	<input type="radio"/>	<input type="radio"/>
Secure	<input type="radio"/>	<input type="radio"/>	<input type="radio"/>	<input type="radio"/>	<input type="radio"/>	<input type="radio"/>	<input type="radio"/>	<input type="radio"/>	<input type="radio"/>	<input type="radio"/>	<input type="radio"/>	<input type="radio"/>	<input type="radio"/>	<input type="radio"/>	<input type="radio"/>	<input type="radio"/>	<input type="radio"/>	<input type="radio"/>	<input type="radio"/>	<input type="radio"/>

VLAN Learning Configuration

Learning-disabled VLANs

Static MAC Table Configuration

Delete	VLAN ID	MAC Address	Port Members																			
			1	2	3	4	5	6	7	8	9	10	11	12	13	14	15	16	17	18	19	20
<input type="button" value="Add New Static Entry"/>																						
<input type="button" value="Save"/>	<input type="button" value="Reset"/>																					

Aging Configuration

Disable Automatic Aging: Learned MAC addresses will appear in the table permanently.

Aging Time: Set up the aging time for a learned MAC to be appeared in MAC learning table. The allowed range is 10 to 1000000 seconds.

MAC Table Learning

MAC Learning Table: Three options are available on each port.

Auto: On a given port, learning is automatically done once unknown SMAC is received.

Disable: Disable MAC learning function.

Secure: Only static MAC entries listed in “Static MAC Table Configuration” are learned. Others will be dropped.

NOTE: Make sure that the link used for managing the switch is added to the Static Mac Table before changing to secure learning mode, otherwise the management link is lost and can only be restored by using another non-secure port or by connecting to the switch via the serial interface.

VLAN Learning Configuration

Learning-disabled VLANs: This field shows the Learning-disabled VLANs. When a new MAC arrives into a learning-disabled VLAN, the MAC will not be learnt. By default, the field is empty. More VLANs can be created into the list. The following example will create VLANs 1, 10, 11, 12, 13, 200 and 300: 1, 10-13, 200, 300.

Static MAC Table Configuration

Static MAC Table Configuration: This table is used to manually set up static MAC entries. The total entries that can be entered are 64.

Delete: Delete this MAC address entry.

VLAN ID: Specify the VLAN ID for this entry.

Port Members: Check or uncheck the ports. If the incoming packet has the same destination MAC address as the one specified in VID, it will be forwarded to the checked port directly.

4.14.2 MAC Address Table

The MAC Address Table shows both static and dynamic MAC addresses learned from CPU or switch ports. You can enter the starting VLAN ID and MAC addresses to view the desired entries.

Type	VLAN	MAC Address	CPU	Port Members																			
				1	2	3	4	5	6	7	8	9	10	11	12	13	14	15	16	17	18	19	20
Static	1	00-02-AB-D9-D5-C5	✓																				
Dynamic	1	00-E0-4C-36-15-4B								✓													
Static	1	33-33-00-00-00-01	✓	✓	✓	✓	✓	✓	✓	✓	✓	✓	✓	✓	✓	✓	✓	✓	✓	✓	✓	✓	
Static	1	33-33-FF-D9-D5-C5	✓	✓	✓	✓	✓	✓	✓	✓	✓	✓	✓	✓	✓	✓	✓	✓	✓	✓	✓	✓	
Static	1	FF-FF-FF-FF-FF-FF	✓	✓	✓	✓	✓	✓	✓	✓	✓	✓	✓	✓	✓	✓	✓	✓	✓	✓	✓	✓	
Static	10	00-02-AB-D9-D5-C5	✓																				
Static	10	33-33-00-00-00-01	✓	✓	✓	✓	✓	✓	✓	✓	✓	✓	✓	✓	✓	✓	✓	✓	✓	✓	✓	✓	
Static	10	FF-FF-FF-FF-FF-FF	✓	✓	✓	✓	✓	✓	✓	✓	✓	✓	✓	✓	✓	✓	✓	✓	✓	✓	✓	✓	

Type: Display whether the learned MAC address is static or dynamic.

VLAN ID: The VLAN ID associated with this entry.

MAC Address: The MAC address learned on CPU or certain ports.

Port Members: Ports associated with this entry.

4.15 VLAN Translation

VLAN Translation is especially useful for users who want to translate the original VLAN ID to a new VLAN ID so as to exchange data across different VLANs and improve VLAN scaling. VLAN translation replaces an incoming C-VLAN tag with an S-VLAN tag instead of adding an additional tag. When configuring VLAN Translation, both ends of the link normally must be able to replace tags appropriately. In other words, both ends must be configured to translate the C-VLAN tag to S-VLAN tag and S-VLAN tag to C-VLAN tag appropriately in a network. Note that only access ports support VLAN translation. It is not recommended to configure VLAN Translation on trunk ports.

The “VLAN Translation” menu contains the following sub menus. Select the appropriate one to configure settings or view its status.

- VLAN Translation
 - Port to Group Mapping
 - VID Translation Mapping

4.15.1 Port to Group Mapping

VLAN Translation Port Configuration

Port	Group Configuration	
	Default	Group ID
*	<input type="checkbox"/>	<>
1	<input type="checkbox"/>	1
2	<input type="checkbox"/>	2
3	<input type="checkbox"/>	3
4	<input type="checkbox"/>	4
5	<input type="checkbox"/>	5
6	<input type="checkbox"/>	6
7	<input type="checkbox"/>	7
8	<input type="checkbox"/>	8
9	<input type="checkbox"/>	9
10	<input type="checkbox"/>	10
11	<input type="checkbox"/>	11
12	<input type="checkbox"/>	12
13	<input type="checkbox"/>	13
14	<input type="checkbox"/>	14
15	<input type="checkbox"/>	15
16	<input type="checkbox"/>	16
17	<input type="checkbox"/>	17
18	<input type="checkbox"/>	18
19	<input type="checkbox"/>	19
20	<input type="checkbox"/>	20

Default: Check the checkbox to include a port into a default VLAN translation group.

Group ID: The total VLAN Translation group can be used is 20 which is automatically created in Group Mapping Table when entering “Port to Group Mapping” page. A port can be mapped to any of the groups. Multiple ports can be mapped to a single group with the same Group ID.

NOTE: By default, each port is mapped to a group with a group ID equal to the port number. For example, port 2 is mapped to the group with ID is 2.

4.15.2 VID Translation Mapping

Delete	Group ID	VLAN ID	Translated to VID
Delete			

Group ID: Indicate the Group ID that applies to this translation rule.

VLAN ID: Indicate the VLAN ID that will be mapped to a new VID.

Translated to VID: Indicate the new VID to which VID of ingress frames will be changed.

Click the “Add New Entry” button once to add a new VLAN Translation entry.

4.16 VLANs

IEEE 802.1Q VLAN (Virtual Local Area Network) is a popular and cost-effectively way to segment your networking deployment by logically grouping devices with similar attributes irrespective of their physical connections. VLANs also segment the network into different broadcast domains so that packets are forwarded to ports within the VLAN that they belong. Using VLANs provides the following main benefits:

VLANs provide extra security: Devices that frequently communicate with each other are grouped into the same VLAN. If devices in a VLAN want to communicate with devices in a different VLAN, the traffic must go through a routing device or Layer 3 switching device.

VLANs help control traffic: Traditionally, when networks are not segmented into VLANs, congestion can be easily caused by broadcast traffic that is directed to all devices. To minimize the possibility of broadcast traffic damaging the entire network, VLANs can help group devices that communicate frequently with other in the same VLAN so as to divide the entire network into several broadcast domains.

VLANs make changes of devices or relocation more easily: In traditional networks, when moving a device geographically to a new location (for example, move a device in floor 2 to floor 4), the network administrator may need to change the IP or even subnet of the network or require re-cabling. However, by using VLANs, the original IP settings can remain the same and re-cabling can be reduced to minimal.

The “VLAN” menu contains the following sub menus. Select the appropriate one to set up the detailed configurations.

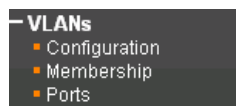

4.16.1 Configuration

Global VLAN Configuration

Allowed Access VLANs	1
Ethertype for Custom S-ports	88A8

Port VLAN Configuration

Port	Mode	Port VLAN	Port Type	Ingress Filtering	Ingress Acceptance	Egress Tagging	Allowed VLANs	Forbidden VLANs
*	<>	1	<>	<input checked="" type="checkbox"/>	<>	<>	1	
1	Access	1	C-Port	<input checked="" type="checkbox"/>	Tagged and Untagged	Untag All	1	
2	Access	1	C-Port	<input checked="" type="checkbox"/>	Tagged and Untagged	Untag All	1	
3	Access	1	C-Port	<input checked="" type="checkbox"/>	Tagged and Untagged	Untag All	1	
4	Access	1	C-Port	<input checked="" type="checkbox"/>	Tagged and Untagged	Untag All	1	
5	Access	1	C-Port	<input checked="" type="checkbox"/>	Tagged and Untagged	Untag All	1	
6	Access	1	C-Port	<input checked="" type="checkbox"/>	Tagged and Untagged	Untag All	1	
7	Access	1	C-Port	<input checked="" type="checkbox"/>	Tagged and Untagged	Untag All	1	
8	Access	1	C-Port	<input checked="" type="checkbox"/>	Tagged and Untagged	Untag All	1	
9	Access	1	C-Port	<input checked="" type="checkbox"/>	Tagged and Untagged	Untag All	1	
10	Access	1	C-Port	<input checked="" type="checkbox"/>	Tagged and Untagged	Untag All	1	
11	Access	1	C-Port	<input checked="" type="checkbox"/>	Tagged and Untagged	Untag All	1	
12	Access	1	C-Port	<input checked="" type="checkbox"/>	Tagged and Untagged	Untag All	1	
13	Access	1	C-Port	<input checked="" type="checkbox"/>	Tagged and Untagged	Untag All	1	
14	Access	1	C-Port	<input checked="" type="checkbox"/>	Tagged and Untagged	Untag All	1	
15	Access	1	C-Port	<input checked="" type="checkbox"/>	Tagged and Untagged	Untag All	1	
16	Access	1	C-Port	<input checked="" type="checkbox"/>	Tagged and Untagged	Untag All	1	
17	Hybrid	1	C-Port	<input type="checkbox"/>	Tagged and Untagged	Untag Port VLAN	1-4095	
18	Hybrid	1	C-Port	<input type="checkbox"/>	Tagged and Untagged	Untag Port VLAN	1-4095	
19	Hybrid	1	C-Port	<input type="checkbox"/>	Tagged and Untagged	Untag Port VLAN	1-4095	
20	Hybrid	1	C-Port	<input type="checkbox"/>	Tagged and Untagged	Untag Port VLAN	1-4095	

Global VLAN Configuration

Allowed Access VLANs: This shows the allowed access VLANs. This setting only affects ports set in “Access” mode. Ports in other modes are members of all VLANs specified in “Allowed VLANs” field. By default, only VLAN 1 is specified. More allowed access VLANs can be entered by specifying the individual VLAN ID separated by comma. If you want to specify a range, separate it by a dash. For example, 1, 5, 10, 12-15, 100

Ethertype for Custom S-ports: Specify ether type used for customer s-ports.

Port VLAN Configuration

Port: List the number of each port. “Port *” settings apply to all ports.

Mode: The port mode (default is Access) determines the fundamental behavior of the port in question. A port can be in one of three modes as described below. Whenever a particular mode is selected, the remaining fields in that row will be either grayed out or made changeable depending on the mode in question. Grayed out fields show the value that the port will get when the mode is applied.

Access: Access ports are normally used to connect to end stations. Dynamic features like Voice VLAN may add the port to more VLANs behind the scenes. Access ports have the following characteristics:

- Member of exactly one VLAN, the Port VLAN (a.k.a. Access VLAN), which by default is 1.
- Accepts untagged and C-tagged frames.
- Discards all frames that are not classified to the Access VLAN.
- On egress all frames classified to the Access VLAN are transmitted untagged. Other (dynamically added VLANs) are transmitted tagged.

Trunk: Trunk ports can carry traffic on multiple VLANs simultaneously, and are normally used to connect to other switches. Trunk ports have the following characteristics:

- By default, a trunk port is member of all VLANs (1-4095).
- The VLANs that a trunk port is member of may be limited by the use of “Allowed VLANs”.
- Frames classified to a VLAN that the port is not a member of are discarded.

- By default, all frames but frames classified to the Port VLAN (a.k.a. Native VLAN) get tagged on egress. Frames classified to the Port VLAN do not get C-tagged on egress.
- Egress tagging can be changed to tag all frames, in which case only tagged frames are accepted on ingress.

Hybrid: Hybrid ports resemble trunk ports in many ways, but adds additional port configuration features. In addition to the characteristics described for trunk ports, hybrid ports have these abilities:

- Can be configured to be VLAN tag unaware, C-tag aware, S-tag aware, or S-custom-tag aware.
- Ingress filtering can be controlled.
- Ingress acceptance of frames and configuration of egress tagging can be configured independently.

Port VLAN: Configures the VLAN identifier for the port. The allowed values are from 1 through 4095. The default value is 1.

The Port VLAN is called an "Access VLAN" for ports in Access mode and Native VLAN for ports in Trunk or Hybrid mode.

Port Type: When you select "Hybrid" mode, the Port Type field becomes selectable. There are four port types available. Each port type's ingress and egress action is described in the following table.

Action Port Type	Ingress Action	Egress Action
Unaware	When a tagged frame is received on a port, 1. If the tagged frame with TPID=0x8100, it becomes a double-tag frame and is forwarded. 2. If the TPID of tagged frame is not 0x8100 (ex. 0x88A8), it will be discarded.	The TPID of frame transmitted by Unaware port will be set to 0x8100. The final status of the frame after egressing are also affected by egress rule.
	When an untagged frame is received on a port, a tag (PVID) is attached and then forwarded.	
C-port	When a tagged frame is received on a port, 1. If a tagged frame with TPID=0x8100, it is forwarded. 2. If the TPID of tagged frame is not 0x8100 (ex. 0x88A8), it will be discarded.	The TPID of frame transmitted by C-port will be set to 0x8100.
	When an untagged frame is received on a port, a tag (PVID) is attached and then forwarded.	
S-port	When a tagged frame is received on a port, 1. If a tagged frame with TPID=0x88A8, it is forwarded. 2. If the TPID of tagged frame is not 0x88A8 (ex. 0x8810), it will be discarded.	The TPID of frame transmitted by S-port will be set to 0x88A8
	When an untagged frame is received on a port, a tag (PVID) is attached and then forwarded.	
S-custom port	When a tagged frame is received on a port, 1. If a tagged frame with TPID=0x88A8, it is forwarded. 2. If the TPID of tagged frame is not 0x88A8 (ex. 0x8810), it will be discarded.	The TPID of frame transmitted by S-custom-port will be set to a self-customized value, which can be set by the user using the column of Ethertype for Custom S-ports.
	When an untagged frame is received on a port, a tag (PVID) is attached and then forwarded.	

Ingress Filtering: When you select "Hybrid" mode, the Ingress Filtering field becomes selectable. If Ingress Filtering is enabled and the ingress port is not a member of a VLAN, the frame from the ingress port is discarded. By default, ingress filtering is disabled.

Ingress Acceptance: Select the acceptable ingress traffic type on a port. (Available when Hybrid mode is selected.)

Tagged and Untagged: Both tagged and untagged ingress packets are acceptable on a port.

Tagged Only: Only tagged ingress packets are acceptable on a port. Untagged packets will be dropped.

Untagged Only: Only untagged ingress packets are acceptable on a port. Tagged packets will be dropped.

Egress Tagging: The action taken when packets are sent out from a port. (Available when Hybrid or Trunk mode is selected.)

Untag Port VLAN: Frames that carry PVID will be removed when leaving from a port. Frames with tags other than PVID will be transmitted with the carried tags.

Tag All: Frames are transmitted with a tag.

Untag All: Frames are transmitted without a tag. This option is only available for ports in Hybrid mode.

Allowed VLAN: Ports in Trunk and Hybrid mode may control which VLANs they are allowed to become members of. Access ports can only be member of one VLAN, the Access VLAN. By default, a Trunk or Hybrid port will become member of all VLANs, and is therefore set to 1-4095.

Forbidden VLAN: A port may be configured to never be a member of one or more VLANs. This is particularly useful when dynamic VLAN protocols like MVRP and GVRP must be prevented from dynamically adding ports to VLANs. The trick is to mark such VLANs as forbidden on the port in question. By default, the field is left blank, which means that the port may become a member of all possible VLANs.

4.16.2 SVL

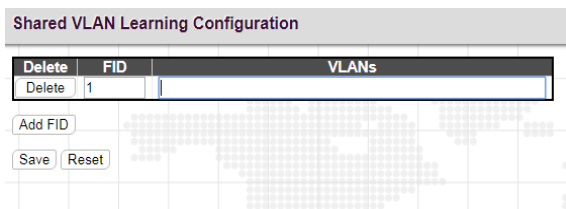

FID: The Filter ID (FID) is the ID that VLANs get learned in the MAC table when SLV is in effect. Each FID listed on the table must be different.

VLAN: Indicate a list of VLANs which are mapped to FID.

4.16.3 Membership

VLAN Membership Status for Combined users Combined Auto-refresh Refresh

Start from VLAN with entries per page. |<< >>|

VLAN ID	Port Members																			
	1	2	3	4	5	6	7	8	9	10	11	12	13	14	15	16	17	18	19	20
1	<input checked="" type="checkbox"/>	<input checked="" type="checkbox"/>	<input checked="" type="checkbox"/>	<input checked="" type="checkbox"/>	<input checked="" type="checkbox"/>	<input checked="" type="checkbox"/>	<input checked="" type="checkbox"/>	<input checked="" type="checkbox"/>	<input checked="" type="checkbox"/>	<input checked="" type="checkbox"/>	<input checked="" type="checkbox"/>	<input checked="" type="checkbox"/>	<input checked="" type="checkbox"/>	<input checked="" type="checkbox"/>	<input checked="" type="checkbox"/>	<input checked="" type="checkbox"/>	<input checked="" type="checkbox"/>	<input checked="" type="checkbox"/>	<input checked="" type="checkbox"/>	<input checked="" type="checkbox"/>
2	<input type="checkbox"/>	<input type="checkbox"/>	<input type="checkbox"/>	<input type="checkbox"/>	<input type="checkbox"/>	<input type="checkbox"/>	<input type="checkbox"/>	<input type="checkbox"/>	<input type="checkbox"/>	<input type="checkbox"/>	<input type="checkbox"/>	<input type="checkbox"/>	<input type="checkbox"/>	<input type="checkbox"/>	<input type="checkbox"/>	<input type="checkbox"/>	<input type="checkbox"/>	<input type="checkbox"/>	<input type="checkbox"/>	<input type="checkbox"/>
3	<input type="checkbox"/>	<input type="checkbox"/>	<input type="checkbox"/>	<input type="checkbox"/>	<input type="checkbox"/>	<input type="checkbox"/>	<input type="checkbox"/>	<input type="checkbox"/>	<input type="checkbox"/>	<input type="checkbox"/>	<input type="checkbox"/>	<input type="checkbox"/>	<input type="checkbox"/>	<input type="checkbox"/>	<input type="checkbox"/>	<input type="checkbox"/>	<input type="checkbox"/>	<input checked="" type="checkbox"/>	<input checked="" type="checkbox"/>	<input checked="" type="checkbox"/>
4	<input type="checkbox"/>	<input type="checkbox"/>	<input type="checkbox"/>	<input type="checkbox"/>	<input type="checkbox"/>	<input type="checkbox"/>	<input type="checkbox"/>	<input type="checkbox"/>	<input type="checkbox"/>	<input type="checkbox"/>	<input type="checkbox"/>	<input type="checkbox"/>	<input type="checkbox"/>	<input type="checkbox"/>	<input type="checkbox"/>	<input type="checkbox"/>	<input type="checkbox"/>	<input checked="" type="checkbox"/>	<input checked="" type="checkbox"/>	<input checked="" type="checkbox"/>
5	<input type="checkbox"/>	<input type="checkbox"/>	<input type="checkbox"/>	<input type="checkbox"/>	<input type="checkbox"/>	<input type="checkbox"/>	<input type="checkbox"/>	<input type="checkbox"/>	<input type="checkbox"/>	<input type="checkbox"/>	<input type="checkbox"/>	<input type="checkbox"/>	<input type="checkbox"/>	<input type="checkbox"/>	<input type="checkbox"/>	<input type="checkbox"/>	<input type="checkbox"/>	<input checked="" type="checkbox"/>	<input checked="" type="checkbox"/>	<input checked="" type="checkbox"/>
6	<input type="checkbox"/>	<input type="checkbox"/>	<input type="checkbox"/>	<input type="checkbox"/>	<input type="checkbox"/>	<input type="checkbox"/>	<input type="checkbox"/>	<input type="checkbox"/>	<input type="checkbox"/>	<input type="checkbox"/>	<input type="checkbox"/>	<input type="checkbox"/>	<input type="checkbox"/>	<input type="checkbox"/>	<input type="checkbox"/>	<input type="checkbox"/>	<input type="checkbox"/>	<input checked="" type="checkbox"/>	<input checked="" type="checkbox"/>	<input checked="" type="checkbox"/>
7	<input type="checkbox"/>	<input type="checkbox"/>	<input type="checkbox"/>	<input type="checkbox"/>	<input type="checkbox"/>	<input type="checkbox"/>	<input type="checkbox"/>	<input type="checkbox"/>	<input type="checkbox"/>	<input type="checkbox"/>	<input type="checkbox"/>	<input type="checkbox"/>	<input type="checkbox"/>	<input type="checkbox"/>	<input type="checkbox"/>	<input type="checkbox"/>	<input type="checkbox"/>	<input checked="" type="checkbox"/>	<input checked="" type="checkbox"/>	<input checked="" type="checkbox"/>
8	<input type="checkbox"/>	<input type="checkbox"/>	<input type="checkbox"/>	<input type="checkbox"/>	<input type="checkbox"/>	<input type="checkbox"/>	<input type="checkbox"/>	<input type="checkbox"/>	<input type="checkbox"/>	<input type="checkbox"/>	<input type="checkbox"/>	<input type="checkbox"/>	<input type="checkbox"/>	<input type="checkbox"/>	<input type="checkbox"/>	<input type="checkbox"/>	<input type="checkbox"/>	<input checked="" type="checkbox"/>	<input checked="" type="checkbox"/>	<input checked="" type="checkbox"/>
9	<input type="checkbox"/>	<input type="checkbox"/>	<input type="checkbox"/>	<input type="checkbox"/>	<input type="checkbox"/>	<input type="checkbox"/>	<input type="checkbox"/>	<input type="checkbox"/>	<input type="checkbox"/>	<input type="checkbox"/>	<input type="checkbox"/>	<input type="checkbox"/>	<input type="checkbox"/>	<input type="checkbox"/>	<input type="checkbox"/>	<input type="checkbox"/>	<input type="checkbox"/>	<input checked="" type="checkbox"/>	<input checked="" type="checkbox"/>	<input checked="" type="checkbox"/>
10	<input type="checkbox"/>	<input type="checkbox"/>	<input type="checkbox"/>	<input type="checkbox"/>	<input type="checkbox"/>	<input type="checkbox"/>	<input type="checkbox"/>	<input type="checkbox"/>	<input type="checkbox"/>	<input type="checkbox"/>	<input type="checkbox"/>	<input type="checkbox"/>	<input type="checkbox"/>	<input type="checkbox"/>	<input type="checkbox"/>	<input type="checkbox"/>	<input type="checkbox"/>	<input checked="" type="checkbox"/>	<input checked="" type="checkbox"/>	<input checked="" type="checkbox"/>
11	<input type="checkbox"/>	<input type="checkbox"/>	<input type="checkbox"/>	<input type="checkbox"/>	<input type="checkbox"/>	<input type="checkbox"/>	<input type="checkbox"/>	<input type="checkbox"/>	<input type="checkbox"/>	<input type="checkbox"/>	<input type="checkbox"/>	<input type="checkbox"/>	<input type="checkbox"/>	<input type="checkbox"/>	<input type="checkbox"/>	<input type="checkbox"/>	<input type="checkbox"/>	<input checked="" type="checkbox"/>	<input checked="" type="checkbox"/>	<input checked="" type="checkbox"/>
12	<input type="checkbox"/>	<input type="checkbox"/>	<input type="checkbox"/>	<input type="checkbox"/>	<input type="checkbox"/>	<input type="checkbox"/>	<input type="checkbox"/>	<input type="checkbox"/>	<input type="checkbox"/>	<input type="checkbox"/>	<input type="checkbox"/>	<input type="checkbox"/>	<input type="checkbox"/>	<input type="checkbox"/>	<input type="checkbox"/>	<input type="checkbox"/>	<input type="checkbox"/>	<input checked="" type="checkbox"/>	<input checked="" type="checkbox"/>	<input checked="" type="checkbox"/>
13	<input type="checkbox"/>	<input type="checkbox"/>	<input type="checkbox"/>	<input type="checkbox"/>	<input type="checkbox"/>	<input type="checkbox"/>	<input type="checkbox"/>	<input type="checkbox"/>	<input type="checkbox"/>	<input type="checkbox"/>	<input type="checkbox"/>	<input type="checkbox"/>	<input type="checkbox"/>	<input type="checkbox"/>	<input type="checkbox"/>	<input type="checkbox"/>	<input type="checkbox"/>	<input checked="" type="checkbox"/>	<input checked="" type="checkbox"/>	<input checked="" type="checkbox"/>
14	<input type="checkbox"/>	<input type="checkbox"/>	<input type="checkbox"/>	<input type="checkbox"/>	<input type="checkbox"/>	<input type="checkbox"/>	<input type="checkbox"/>	<input type="checkbox"/>	<input type="checkbox"/>	<input type="checkbox"/>	<input type="checkbox"/>	<input type="checkbox"/>	<input type="checkbox"/>	<input type="checkbox"/>	<input type="checkbox"/>	<input type="checkbox"/>	<input type="checkbox"/>	<input checked="" type="checkbox"/>	<input checked="" type="checkbox"/>	<input checked="" type="checkbox"/>
15	<input type="checkbox"/>	<input type="checkbox"/>	<input type="checkbox"/>	<input type="checkbox"/>	<input type="checkbox"/>	<input type="checkbox"/>	<input type="checkbox"/>	<input type="checkbox"/>	<input type="checkbox"/>	<input type="checkbox"/>	<input type="checkbox"/>	<input type="checkbox"/>	<input type="checkbox"/>	<input type="checkbox"/>	<input type="checkbox"/>	<input type="checkbox"/>	<input type="checkbox"/>	<input checked="" type="checkbox"/>	<input checked="" type="checkbox"/>	<input checked="" type="checkbox"/>
16	<input type="checkbox"/>	<input type="checkbox"/>	<input type="checkbox"/>	<input type="checkbox"/>	<input type="checkbox"/>	<input type="checkbox"/>	<input type="checkbox"/>	<input type="checkbox"/>	<input type="checkbox"/>	<input type="checkbox"/>	<input type="checkbox"/>	<input type="checkbox"/>	<input type="checkbox"/>	<input type="checkbox"/>	<input type="checkbox"/>	<input type="checkbox"/>	<input type="checkbox"/>	<input checked="" type="checkbox"/>	<input checked="" type="checkbox"/>	<input checked="" type="checkbox"/>
17	<input type="checkbox"/>	<input type="checkbox"/>	<input type="checkbox"/>	<input type="checkbox"/>	<input type="checkbox"/>	<input type="checkbox"/>	<input type="checkbox"/>	<input type="checkbox"/>	<input type="checkbox"/>	<input type="checkbox"/>	<input type="checkbox"/>	<input type="checkbox"/>	<input type="checkbox"/>	<input type="checkbox"/>	<input type="checkbox"/>	<input type="checkbox"/>	<input type="checkbox"/>	<input checked="" type="checkbox"/>	<input checked="" type="checkbox"/>	<input checked="" type="checkbox"/>
18	<input type="checkbox"/>	<input type="checkbox"/>	<input type="checkbox"/>	<input type="checkbox"/>	<input type="checkbox"/>	<input type="checkbox"/>	<input type="checkbox"/>	<input type="checkbox"/>	<input type="checkbox"/>	<input type="checkbox"/>	<input type="checkbox"/>	<input type="checkbox"/>	<input type="checkbox"/>	<input type="checkbox"/>	<input type="checkbox"/>	<input type="checkbox"/>	<input type="checkbox"/>	<input checked="" type="checkbox"/>	<input checked="" type="checkbox"/>	<input checked="" type="checkbox"/>
19	<input type="checkbox"/>	<input type="checkbox"/>	<input type="checkbox"/>	<input type="checkbox"/>	<input type="checkbox"/>	<input type="checkbox"/>	<input type="checkbox"/>	<input type="checkbox"/>	<input type="checkbox"/>	<input type="checkbox"/>	<input type="checkbox"/>	<input type="checkbox"/>	<input type="checkbox"/>	<input type="checkbox"/>	<input type="checkbox"/>	<input type="checkbox"/>	<input type="checkbox"/>	<input checked="" type="checkbox"/>	<input checked="" type="checkbox"/>	<input checked="" type="checkbox"/>
20	<input type="checkbox"/>	<input type="checkbox"/>	<input type="checkbox"/>	<input type="checkbox"/>	<input type="checkbox"/>	<input type="checkbox"/>	<input type="checkbox"/>	<input type="checkbox"/>	<input type="checkbox"/>	<input type="checkbox"/>	<input type="checkbox"/>	<input type="checkbox"/>	<input type="checkbox"/>	<input type="checkbox"/>	<input type="checkbox"/>	<input type="checkbox"/>	<input type="checkbox"/>	<input checked="" type="checkbox"/>	<input checked="" type="checkbox"/>	<input checked="" type="checkbox"/>

This page shows the current VLAN membership saved on the Switch.

VLAN ID: VLANs that are already created.

Port members: Display member ports on the configured VLANs.

4.16.4 Ports

VLAN Port Status for Combined users

Port	Port Type	Ingress Filtering	Frame Type	Port VLAN ID	Tx Tag	Untagged VLAN ID	Conflicts
1	C-Port	<input checked="" type="checkbox"/>	All	1	Untag PVID		No
2	C-Port	<input checked="" type="checkbox"/>	All	1	Untag PVID		No
3	C-Port	<input checked="" type="checkbox"/>	All	1	Untag PVID		No
4	C-Port	<input checked="" type="checkbox"/>	All	1	Untag PVID		No
5	C-Port	<input checked="" type="checkbox"/>	All	1	Untag PVID		No
6	C-Port	<input checked="" type="checkbox"/>	All	1	Untag PVID		No
7	C-Port	<input checked="" type="checkbox"/>	All	1	Untag PVID		No
8	C-Port	<input checked="" type="checkbox"/>	All	1	Untag PVID		No
9	C-Port	<input checked="" type="checkbox"/>	All	1	Untag PVID		No
10	C-Port	<input checked="" type="checkbox"/>	All	1	Untag PVID		No
11	C-Port	<input checked="" type="checkbox"/>	All	1	Untag PVID		No
12	C-Port	<input checked="" type="checkbox"/>	All	1	Untag PVID		No
13	C-Port	<input checked="" type="checkbox"/>	All	1	Untag PVID		No
14	C-Port	<input checked="" type="checkbox"/>	All	1	Untag PVID		No
15	C-Port	<input checked="" type="checkbox"/>	All	1	Untag PVID		No
16	C-Port	<input checked="" type="checkbox"/>	All	1	Untag PVID		No
17	C-Port	<input checked="" type="checkbox"/>	All	1	Untag PVID		No
18	C-Port	<input checked="" type="checkbox"/>	All	1	Untag PVID		No
19	C-Port	<input checked="" type="checkbox"/>	All	1	Untag PVID		No
20	C-Port	<input checked="" type="checkbox"/>	All	1	Untag PVID		No

This page shows the current VLAN settings on a per-port basis saved on the Switch.

Port: The port number.

Port Type: Display the selected port type on a port.

Ingress Filtering: Display whether Ingress Filtering is enabled or disabled.

Frame Type: Display the accepted frame type on a port.

Port VLAN ID: The port VLAN ID assigned to a port.

Tx Tag: Display the Egress action on a port.

Untagged VLAN ID: Display the untagged VLAN ID. A port's UVID determines the packet's behavior at the egress side. If the VID of Ethernet frames leaving a port match the UVID, these frames will be sent untagged.

Conflicts: Display whether conflicts exist or not. When a software module requests to set VLAN membership or VLAN port configuration, the following conflicts can occur:

- *Functional conflicts between features.
- *Conflicts due to hardware limitations.
- *Direct conflicts between user modules.
- *Direct conflicts between user modules.

4.17 Private VLANs

The “Private VLANs” menu contains the following sub menus. Select the appropriate one to configure its detailed settings.

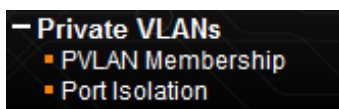

4.17.1 PVLAN Membership

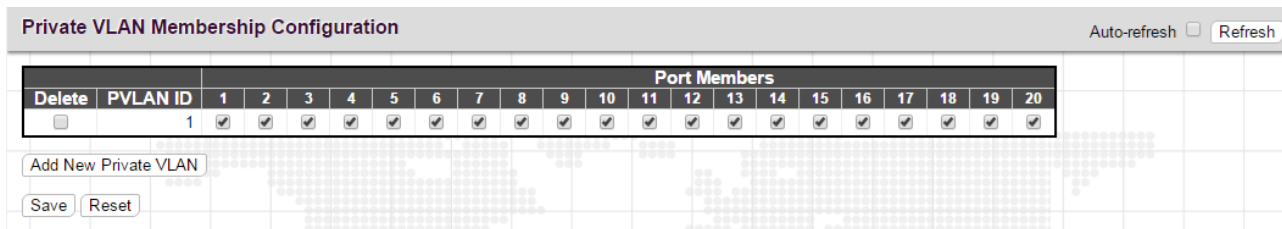

This page is used to configure private VLANs. New Private VLANs can be added here and existing VLANs can be modified. Private VLANs are based on the source port mask and there are no connections to VLANs which means that VLAN IDs and Private VLAN IDs can be identical. A port must be a member of both a VLAN and a Private VLAN to be able to forward packets. By default, all ports are VLAN unaware and members of VLAN 1 and Private VLAN 1. A VLAN unaware port can only be a member of one VLAN, but it can be a member of multiple Private VLANs.

PVLAN ID: Specify the PVLAN ID. Valid values are 1 to 24.

Port Members: Select the checkbox, if you would like a port to belong to a certain Private VLAN. Uncheck the checkbox to remove a port from a Private VLAN.

Delete: Delete this VLAN membership entry.

Add New VLAN: Click the button once to add a new VLAN entry.

Save: VLAN membership changes will be saved and new VLANs are enabled after clicking “Save” button.

Reset: Click “Reset” button to clear all unsaved VLAN settings and changes.

4.17.2 Port Isolation

The screenshot shows a configuration window titled "Port Isolation Configuration". It features a table with 20 columns labeled "Port Number" from 1 to 20. Each column contains a small square checkbox. Below the table are two buttons: "Save" and "Reset".

Private VLAN is used to group ports together so as to prevent communications within PVLAN. Port Isolation is used to prevent communications between customer ports in a same Private VLAN. The port that is isolated from others cannot forward any unicast, multicast or broadcast traffic to any other ports in the same PVLAN.

Port Number: Select the checkbox if you want a port or ports to be isolated from other ports.

4.18 GVRP

GVRP (GVRP VLAN Registration Protocol) is defined in the IEEE 802.1Q standard and enables the switch to dynamically create IEEE 802.1Q compliant VLANs between GVRP-enabled devices. With GVRP, VLAN information can be automatically propagated from device to device so as to reduce errors when creating VLANs manually and provide VIDs consistency across network.

This section provides configuration pages for users to set up GVRP timers and enable GVRP on a per-port basis.

The screenshot shows a dark grey menu box with the title "GVRP". Below the title are two items, each preceded by a small orange square icon: "Global Configuration" and "Port Configuration".

4.18.1 Global Configuration

The screenshot shows a configuration window titled "GVRP Configuration". It contains a table with the following settings:

Global Enable	<input type="checkbox"/>
VLAN Prompting	<input checked="" type="checkbox"/>
Join-time	20
Leave-time	60
LeaveAll-time	1000
Max VLANs	20

Below the table is a "Save" button.

Enable GVRP: Select the checkbox to globally enable GVRP function.

VLAN Prompting: Select the checkbox to enable the device to send Empty packets to prompt other devices to send Join-in and Join-empty packets.

Join-time: Specify the amount of time in units of centi-seconds that PDUs are transmitted. The default value is 20 centi-seconds. The valid value is 1~20.

NOTE: The "Leave-time" parameter must be three times greater than or equal to Join time.

Leave-time: Specify the amount of time in units of centi-seconds that the device waits before deleting the associated entry. The leave time is activated by a “Leave All-time” message sent/received and cancelled by the Join message. The default value is 60 centi-seconds.

LeaveAll-time: Specify the amount of time that “LeaveAll” PDUs are created. A LeaveAll PDU indicates that all registrations are shortly de-registered. Participants will need to rejoin in order to maintain registration. The valid value is 1000 to 5000 centi-seconds. The factory default 1000 centi-seconds.

NOTE: The “LeaveAll-time” parameter must be greater than the “Leave-time” parameter.

Max VLANs: The maximum number of VLANs can be learned via GVRP.

4.18.2 Port Configuration

GVRP Port Configuration	
Port	Mode
*	<>
1	Disabled
2	Disabled
3	Disabled
4	Disabled
5	Disabled
6	Disabled
7	Disabled
8	Disabled
9	Disabled
10	Disabled
11	Disabled
12	Disabled
13	Disabled
14	Disabled
15	Disabled
16	Disabled
17	Disabled
18	Disabled
19	Disabled
20	Disabled

Port: The port number.

Mode: Enable GVRP on a per port basis.

4.19 VCL

The “VCL” menu contains the following sub menus.

- VCL
 - MAC-based
 - Membership Configuration
 - Membership Status
 - Protocol-based VLAN
 - Protocol to Group
 - Group to VLAN
 - IP Subnet-based VLAN

4.19.1 MAC-based

MAC-based VLAN configuration page is to set up VLANs based on source MAC addresses. When ingress untagged frames are received by a port, source MAC address is processed to decide which VLAN these untagged frames belong. When source MAC addresses does not match the rules created, untagged frames are assigned to the receiving port's native VLAN ID (PVID).

4.19.1.1 Membership Configuration

MAC-based VLAN Membership Configuration			Port Members																				
Delete	MAC Address	VLAN ID	1	2	3	4	5	6	7	8	9	10	11	12	13	14	15	16	17	18	19	20	
Currently no entries present																							

Auto-refresh Refresh

MAC Address: Indicate the source MAC address. Please note that the source MAC address can only map to one VLAN ID.

VLAN ID: Map this MAC address to the associated VLAN ID.

Port Members: Ports that belong to this VLAN.

Save: Changes will be saved and newly entered rules are enabled after clicking “Save” button.

Click “Add New Entry” to create a new rule.

Delete: Click “Delete” to remove this entry.

4.19.1.2 Membership Status

MAC-based VLAN Membership Status			Port Members																				
MAC Address	VLAN ID		1	2	3	4	5	6	7	8	9	10	11	12	13	14	15	16	17	18	19	20	
No data exists for the user																							

This page shows the status of current VCL rules.

MAC Address: Display the configured MAC addresses.

VLAN ID: Display the VLAN ID of this membership entry.

Port Members: Display ports that accept the configured MAC address.

4.19.2 Protocol-based VLAN

The network devices required to support multiple protocols cannot be easily grouped into a common VLAN. This may require non-standard devices to pass traffic between different VLANs in order to encompass all the devices participating in a specific protocol. This kind of configuration deprives users of the basic benefits of VLANs, including security and easy accessibility.

To avoid these problems, you can configure this switch with protocol-based VLANs that divide the physical network into logical VLAN groups for each required protocol. When a frame is received at a port, its VLAN membership can then be determined based on the protocol type being used by the inbound packets.

4.19.2.1 Protocol to Group

The image displays three sequential screenshots of a web configuration interface for setting up protocol-based VLANs. Each screenshot shows a 'Protocol to Group Mapping Table' with the following structure:

Delete	Frame Type	Value	Group Name
<input type="button" value="Delete"/>	Ethernet	Etype: 0x0800	

Below the table are buttons for 'Add New Entry', 'Save', and 'Reset'.

The second screenshot shows the 'SNAP' frame type selected, with the value field containing 'OUI: 0x00-E0-2F' and 'PID: 0x0000'.

The third screenshot shows the 'LLC' frame type selected, with the value field containing 'DSAP: 0xFF' and 'SSAP: 0xFF'.

Frame Type: There are three frame types available for selection; these are “Ethernet”, “SNAP”, and “LLC”. The value field will change accordingly.

Value: This field specifically indicates the protocol type. This value field varies depending on the frame type you selected.

Ethernet: Ether Type (etype) value. By default, it is set to 0x0800. The range allowed is 0x0600 to 0xffff.

SNAP: This includes OUI (Organizationally Unique Identifier) and PID (Protocol ID) values.

OUI: A value in the format of xx-xx-xx where each pair (xx) in the string is a hexadecimal value in the ranges of 0x00-0xff.

PID: If the OUI is hexadecimal 000000, the protocol ID is the Ethernet type field value for the protocol running on top of SNAP. If the OUI is that of a particular organization, the protocol ID is a value assigned by that organization to the protocol running on top of SNAP. In other words, if value

of the OUI field is 00-00-00, then value of the PID will be etherType (0x0600-0xffff), and if value of the OUI is other than 00-00-00, then valid value of the PID will be any value from 0x0000 to 0xffff.

LLC (Logical Link Control): This includes DSAP (Destination Service Access Point) and SSAP (Source Service Access Point) values. By default, the value is 0xff. Valid range is 0x00 to 0xff.

Group Name: Indicate the descriptive name for this entry. This field only allows 16 alphabet characters (a-z; A-Z) or integers (0-9).

4.19.2.2 Group to VLAN

Group Name to VLAN mapping Table			Port Members																			
Delete	Group Name	VLAN ID	1	2	3	4	5	6	7	8	9	10	11	12	13	14	15	16	17	18	19	20
Currently no entries present in the switch																						

Group Name: Indicate the descriptive name for this entry. This field only allows 16 alphabet characters (a-z; A-Z) or integers (0-9).

VLAN ID: Indicate the VLAN ID.

Port Members: Assign ports to this rule.

Click the “Add New Entry” button to insert a new entry to the list.

Click the “Delete” button to remove a newly-inserted entry or select the checkbox to remove a saved entry during the next save.

4.19.3 IP Subnet-based VLAN

IP Subnet-based VLAN configuration is to map untagged ingress frames to a specific VLAN if the source address is found in the IP subnet-to-VLAN mapping table. When IP subnet-based VLAN classification is enabled, the source address of untagged ingress frames are checked against the IP subnet-to-VLAN mapping table. If an entry is found for that subnet, these frames are assigned to the VLAN indicated in the entry. If no IP subnet is matched, the untagged frames are classified as belonging to the receiving port’s VLAN ID (PVID).

IP Subnet-based VLAN Membership Configuration				Port Members																			
Delete	IP Address	Mask Length	VLAN ID	1	2	3	4	5	6	7	8	9	10	11	12	13	14	15	16	17	18	19	20
Currently no entries present																							

VCE ID: Index of the entry. Valid range is 0~128.

IP Address: Indicate the IP address for this rule.

Mask Length: Indicate the network mask length.

VLAN ID: Indicate the VLAN ID.

Port Members: Assign ports to this rule.

Click the **Add New Entry** button to insert a new entry to the list.

Click the **Delete** button to remove a newly-inserted entry or select the checkbox to remove a saved entry during the next save.

4.20 QoS

Network traffic is always unpredictable and the only basic assurance that can be offered is the best effort traffic delivery. To overcome this challenge, Quality of Service (QoS) is applied throughout the network. This ensures that network traffic is prioritized according to specified criteria and receives preferential treatments.

QoS enables you to assign various grades of network service to different types of traffic, such as multi-media, video, protocol-specific, time critical, and file-backup traffic. To set up the priority of packets in this switch, go to “Port Classification” page.

The “QoS” menu contains the following sub menus.

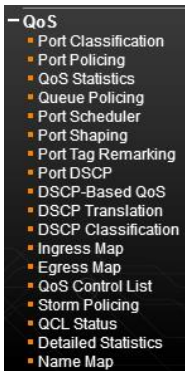

4.20.1 Port Classification

QoS Port Classification									
Port	Ingress					Tag Class.	DSCP Based	Egress	
	CoS	DPL	PCP	DEI	CoS ID			Map	Map
*	<>	<>	<>	<>	<>		<input type="checkbox"/>		
1	0	0	0	0	0	Disabled	<input type="checkbox"/>		
2	0	0	0	0	0	Disabled	<input type="checkbox"/>		
3	0	0	0	0	0	Disabled	<input type="checkbox"/>		
4	0	0	0	0	0	Disabled	<input type="checkbox"/>		
5	0	0	0	0	0	Disabled	<input type="checkbox"/>		
6	0	0	0	0	0	Disabled	<input type="checkbox"/>		
7	0	0	0	0	0	Disabled	<input type="checkbox"/>		
8	0	0	0	0	0	Disabled	<input type="checkbox"/>		
9	0	0	0	0	0	Disabled	<input type="checkbox"/>		
10	0	0	0	0	0	Disabled	<input type="checkbox"/>		
11	0	0	0	0	0	Disabled	<input type="checkbox"/>		
12	0	0	0	0	0	Disabled	<input type="checkbox"/>		
13	0	0	0	0	0	Disabled	<input type="checkbox"/>		
14	0	0	0	0	0	Disabled	<input type="checkbox"/>		
15	0	0	0	0	0	Disabled	<input type="checkbox"/>		
16	0	0	0	0	0	Disabled	<input type="checkbox"/>		
17	0	0	0	0	0	Disabled	<input type="checkbox"/>		
18	0	0	0	0	0	Disabled	<input type="checkbox"/>		
19	0	0	0	0	0	Disabled	<input type="checkbox"/>		
20	0	0	0	0	0	Disabled	<input type="checkbox"/>		

Save Reset

Port: The port number. "All" rules will apply to all ports.

Ingress

CoS class: Indicate the default QoS class. A QoS class of 0 has the lowest priority. By Default, 0 is used.

DP Level: Select the default Drop Precedence Level.

PCP: Select the appropriate value for the default Priority Code Point (or User Priority) for untagged frames.

DEI: Select the appropriate value for the default Drop Eligible Indicator for untagged frames.

CoS ID: Select the default CoS ID. Every incoming frame is classified to a CoS ID which later can be used as basis for rewriting of different parts of the frame.

Tag Class: This field displays classification mode for tagged frames on this port:

Disabled: Use the default QoS class and DP level for tagged frames.

Enabled: Use the mapped versions of PCP and DEI for tagged frames.

DSCP Based: Select the checkbox to enable DSCP based QoS (Ingress Port).

WRED Group: Select the WRED group membership.

Ingress Map: Specify the Ingress Map ID. The valid range is from 0 through 255. An empty field indicates no map selection.

Egress

Egress Map: Specify the Egress Map ID. The valid range is from 0 through 255. An empty field indicates no map selection.

4.20.2 Port Policing

QoS Ingress Port Policers				
Port	Enable	Rate	Unit	Flow Control
*	<input type="checkbox"/>	500	<>	<input type="checkbox"/>
1	<input type="checkbox"/>	500	kbps	<input type="checkbox"/>
2	<input type="checkbox"/>	500	kbps	<input type="checkbox"/>
3	<input type="checkbox"/>	500	kbps	<input type="checkbox"/>
4	<input type="checkbox"/>	500	kbps	<input type="checkbox"/>
5	<input type="checkbox"/>	500	kbps	<input type="checkbox"/>
6	<input type="checkbox"/>	500	kbps	<input type="checkbox"/>
7	<input type="checkbox"/>	500	kbps	<input type="checkbox"/>
8	<input type="checkbox"/>	500	kbps	<input type="checkbox"/>
9	<input type="checkbox"/>	500	kbps	<input type="checkbox"/>
10	<input type="checkbox"/>	500	kbps	<input type="checkbox"/>
11	<input type="checkbox"/>	500	kbps	<input type="checkbox"/>
12	<input type="checkbox"/>	500	kbps	<input type="checkbox"/>
13	<input type="checkbox"/>	500	kbps	<input type="checkbox"/>
14	<input type="checkbox"/>	500	kbps	<input type="checkbox"/>
15	<input type="checkbox"/>	500	kbps	<input type="checkbox"/>
16	<input type="checkbox"/>	500	kbps	<input type="checkbox"/>
17	<input type="checkbox"/>	500	kbps	<input type="checkbox"/>
18	<input type="checkbox"/>	500	kbps	<input type="checkbox"/>
19	<input type="checkbox"/>	500	kbps	<input type="checkbox"/>
20	<input type="checkbox"/>	500	kbps	<input type="checkbox"/>

This page allows users to set each port’s allowed bandwidth.

Port: The port number. “Port *” settings apply to all ports.

Enabled: Select the checkbox to enable port policing function on a port.

Rate: Indicate the rate for the policer. By default, 500kbps is used. The allowed range for kbps and fps is 100 to 1000000. The allowed range for Mbps and kfps is 1 to 3300Mbps.

Unit: Select the unit of measure for the policer.

Flow Control: If flow control is enabled and the port is in flow control mode, then pause frames are sent instead of discarding frames.

4.20.3 QoS Statistics

Queuing Counters																
Port	Q0		Q1		Q2		Q3		Q4		Q5		Q6		Q7	
	Rx	Tx	Rx	Tx	Rx	Tx	Rx	Tx	Rx	Tx	Rx	Tx	Rx	Tx	Rx	Tx
1	0	0	0	0	0	0	0	0	0	0	0	0	0	0	0	0
2	0	0	0	0	0	0	0	0	0	0	0	0	0	0	0	0
3	0	0	0	0	0	0	0	0	0	0	0	0	0	0	0	0
4	0	0	0	0	0	0	0	0	0	0	0	0	0	0	0	0
5	0	0	0	0	0	0	0	0	0	0	0	0	0	0	0	0
6	0	0	0	0	0	0	0	0	0	0	0	0	0	0	0	0
7	0	0	0	0	0	0	0	0	0	0	0	0	0	0	0	0
8	0	0	0	0	0	0	0	0	0	0	0	0	0	0	0	0
9	1067	1388	0	0	0	0	0	0	0	0	0	0	0	0	0	549
10	0	0	0	0	0	0	0	0	0	0	0	0	0	0	0	0
11	0	0	0	0	0	0	0	0	0	0	0	0	0	0	0	0
12	0	0	0	0	0	0	0	0	0	0	0	0	0	0	0	0
13	0	0	0	0	0	0	0	0	0	0	0	0	0	0	0	0
14	0	0	0	0	0	0	0	0	0	0	0	0	0	0	0	0
15	0	0	0	0	0	0	0	0	0	0	0	0	0	0	0	0
16	0	0	0	0	0	0	0	0	0	0	0	0	0	0	0	0
17	0	0	0	0	0	0	0	0	0	0	0	0	0	0	0	0
18	0	0	0	0	0	0	0	0	0	0	0	0	0	0	0	0
19	0	0	0	0	0	0	0	0	0	0	0	0	0	0	0	0
20	0	0	0	0	0	0	0	0	0	0	0	0	0	0	0	0

Q0~Q7: This shows received and transmitted packets of each queue on each port.

4.20.4 Queue Policing

QoS Ingress Queue Policers								
Port	Queue 0	Queue 1	Queue 2	Queue 3	Queue 4	Queue 5	Queue 6	Queue 7
	Enable	Enable	Enable	Enable	Enable	Enable	Enable	Enable
*	<input type="checkbox"/>	<input type="checkbox"/>	<input type="checkbox"/>	<input type="checkbox"/>	<input type="checkbox"/>	<input type="checkbox"/>	<input type="checkbox"/>	<input type="checkbox"/>
1	<input type="checkbox"/>	<input type="checkbox"/>	<input type="checkbox"/>	<input type="checkbox"/>	<input type="checkbox"/>	<input type="checkbox"/>	<input type="checkbox"/>	<input type="checkbox"/>
2	<input type="checkbox"/>	<input type="checkbox"/>	<input type="checkbox"/>	<input type="checkbox"/>	<input type="checkbox"/>	<input type="checkbox"/>	<input type="checkbox"/>	<input type="checkbox"/>
3	<input type="checkbox"/>	<input type="checkbox"/>	<input type="checkbox"/>	<input type="checkbox"/>	<input type="checkbox"/>	<input type="checkbox"/>	<input type="checkbox"/>	<input type="checkbox"/>
4	<input type="checkbox"/>	<input type="checkbox"/>	<input type="checkbox"/>	<input type="checkbox"/>	<input type="checkbox"/>	<input type="checkbox"/>	<input type="checkbox"/>	<input type="checkbox"/>
5	<input type="checkbox"/>	<input type="checkbox"/>	<input type="checkbox"/>	<input type="checkbox"/>	<input type="checkbox"/>	<input type="checkbox"/>	<input type="checkbox"/>	<input type="checkbox"/>
6	<input type="checkbox"/>	<input type="checkbox"/>	<input type="checkbox"/>	<input type="checkbox"/>	<input type="checkbox"/>	<input type="checkbox"/>	<input type="checkbox"/>	<input type="checkbox"/>
7	<input type="checkbox"/>	<input type="checkbox"/>	<input type="checkbox"/>	<input type="checkbox"/>	<input type="checkbox"/>	<input type="checkbox"/>	<input type="checkbox"/>	<input type="checkbox"/>
8	<input type="checkbox"/>	<input type="checkbox"/>	<input type="checkbox"/>	<input type="checkbox"/>	<input type="checkbox"/>	<input type="checkbox"/>	<input type="checkbox"/>	<input type="checkbox"/>
9	<input type="checkbox"/>	<input type="checkbox"/>	<input type="checkbox"/>	<input type="checkbox"/>	<input type="checkbox"/>	<input type="checkbox"/>	<input type="checkbox"/>	<input type="checkbox"/>
10	<input type="checkbox"/>	<input type="checkbox"/>	<input type="checkbox"/>	<input type="checkbox"/>	<input type="checkbox"/>	<input type="checkbox"/>	<input type="checkbox"/>	<input type="checkbox"/>
11	<input type="checkbox"/>	<input type="checkbox"/>	<input type="checkbox"/>	<input type="checkbox"/>	<input type="checkbox"/>	<input type="checkbox"/>	<input type="checkbox"/>	<input type="checkbox"/>
12	<input type="checkbox"/>	<input type="checkbox"/>	<input type="checkbox"/>	<input type="checkbox"/>	<input type="checkbox"/>	<input type="checkbox"/>	<input type="checkbox"/>	<input type="checkbox"/>
13	<input type="checkbox"/>	<input type="checkbox"/>	<input type="checkbox"/>	<input type="checkbox"/>	<input type="checkbox"/>	<input type="checkbox"/>	<input type="checkbox"/>	<input type="checkbox"/>
14	<input type="checkbox"/>	<input type="checkbox"/>	<input type="checkbox"/>	<input type="checkbox"/>	<input type="checkbox"/>	<input type="checkbox"/>	<input type="checkbox"/>	<input type="checkbox"/>
15	<input type="checkbox"/>	<input type="checkbox"/>	<input type="checkbox"/>	<input type="checkbox"/>	<input type="checkbox"/>	<input type="checkbox"/>	<input type="checkbox"/>	<input type="checkbox"/>
16	<input type="checkbox"/>	<input type="checkbox"/>	<input type="checkbox"/>	<input type="checkbox"/>	<input type="checkbox"/>	<input type="checkbox"/>	<input type="checkbox"/>	<input type="checkbox"/>
17	<input type="checkbox"/>	<input type="checkbox"/>	<input type="checkbox"/>	<input type="checkbox"/>	<input type="checkbox"/>	<input type="checkbox"/>	<input type="checkbox"/>	<input type="checkbox"/>
18	<input type="checkbox"/>	<input type="checkbox"/>	<input type="checkbox"/>	<input type="checkbox"/>	<input type="checkbox"/>	<input type="checkbox"/>	<input type="checkbox"/>	<input type="checkbox"/>
19	<input type="checkbox"/>	<input type="checkbox"/>	<input type="checkbox"/>	<input type="checkbox"/>	<input type="checkbox"/>	<input type="checkbox"/>	<input type="checkbox"/>	<input type="checkbox"/>
20	<input type="checkbox"/>	<input type="checkbox"/>	<input type="checkbox"/>	<input type="checkbox"/>	<input type="checkbox"/>	<input type="checkbox"/>	<input type="checkbox"/>	<input type="checkbox"/>

Save Reset

Port: The port number. "Port *" settings apply to all ports.

Queue 0~7 Enable: Select the appropriate checkboxes to enable queue policing function on switch ports.

When enabled, the following image will appear:

QoS Ingress Queue Policers										
Port	E	Queue 0		Queue 1	Queue 2	Queue 3	Queue 4	Queue 5	Queue 6	Queue 7
		Rate	Unit	Enable	Enable	Enable	Enable	Enable	Enable	Enable
*	<input checked="" type="checkbox"/>	500	<>	<input type="checkbox"/>	<input type="checkbox"/>	<input type="checkbox"/>	<input type="checkbox"/>	<input type="checkbox"/>	<input type="checkbox"/>	<input type="checkbox"/>
1	<input checked="" type="checkbox"/>	500	kbps	<input type="checkbox"/>	<input type="checkbox"/>	<input type="checkbox"/>	<input type="checkbox"/>	<input type="checkbox"/>	<input type="checkbox"/>	<input type="checkbox"/>
2	<input checked="" type="checkbox"/>	500	kbps	<input type="checkbox"/>	<input type="checkbox"/>	<input type="checkbox"/>	<input type="checkbox"/>	<input type="checkbox"/>	<input type="checkbox"/>	<input type="checkbox"/>
3	<input checked="" type="checkbox"/>	500	kbps	<input type="checkbox"/>	<input type="checkbox"/>	<input type="checkbox"/>	<input type="checkbox"/>	<input type="checkbox"/>	<input type="checkbox"/>	<input type="checkbox"/>
4	<input checked="" type="checkbox"/>	500	kbps	<input type="checkbox"/>	<input type="checkbox"/>	<input type="checkbox"/>	<input type="checkbox"/>	<input type="checkbox"/>	<input type="checkbox"/>	<input type="checkbox"/>
5	<input checked="" type="checkbox"/>	500	kbps	<input type="checkbox"/>	<input type="checkbox"/>	<input type="checkbox"/>	<input type="checkbox"/>	<input type="checkbox"/>	<input type="checkbox"/>	<input type="checkbox"/>
6	<input checked="" type="checkbox"/>	500	kbps	<input type="checkbox"/>	<input type="checkbox"/>	<input type="checkbox"/>	<input type="checkbox"/>	<input type="checkbox"/>	<input type="checkbox"/>	<input type="checkbox"/>
7	<input checked="" type="checkbox"/>	500	kbps	<input type="checkbox"/>	<input type="checkbox"/>	<input type="checkbox"/>	<input type="checkbox"/>	<input type="checkbox"/>	<input type="checkbox"/>	<input type="checkbox"/>
8	<input checked="" type="checkbox"/>	500	kbps	<input type="checkbox"/>	<input type="checkbox"/>	<input type="checkbox"/>	<input type="checkbox"/>	<input type="checkbox"/>	<input type="checkbox"/>	<input type="checkbox"/>
9	<input checked="" type="checkbox"/>	500	kbps	<input type="checkbox"/>	<input type="checkbox"/>	<input type="checkbox"/>	<input type="checkbox"/>	<input type="checkbox"/>	<input type="checkbox"/>	<input type="checkbox"/>
10	<input checked="" type="checkbox"/>	500	kbps	<input type="checkbox"/>	<input type="checkbox"/>	<input type="checkbox"/>	<input type="checkbox"/>	<input type="checkbox"/>	<input type="checkbox"/>	<input type="checkbox"/>
11	<input checked="" type="checkbox"/>	500	kbps	<input type="checkbox"/>	<input type="checkbox"/>	<input type="checkbox"/>	<input type="checkbox"/>	<input type="checkbox"/>	<input type="checkbox"/>	<input type="checkbox"/>
12	<input checked="" type="checkbox"/>	500	kbps	<input type="checkbox"/>	<input type="checkbox"/>	<input type="checkbox"/>	<input type="checkbox"/>	<input type="checkbox"/>	<input type="checkbox"/>	<input type="checkbox"/>
13	<input checked="" type="checkbox"/>	500	kbps	<input type="checkbox"/>	<input type="checkbox"/>	<input type="checkbox"/>	<input type="checkbox"/>	<input type="checkbox"/>	<input type="checkbox"/>	<input type="checkbox"/>
14	<input checked="" type="checkbox"/>	500	kbps	<input type="checkbox"/>	<input type="checkbox"/>	<input type="checkbox"/>	<input type="checkbox"/>	<input type="checkbox"/>	<input type="checkbox"/>	<input type="checkbox"/>
15	<input checked="" type="checkbox"/>	500	kbps	<input type="checkbox"/>	<input type="checkbox"/>	<input type="checkbox"/>	<input type="checkbox"/>	<input type="checkbox"/>	<input type="checkbox"/>	<input type="checkbox"/>
16	<input checked="" type="checkbox"/>	500	kbps	<input type="checkbox"/>	<input type="checkbox"/>	<input type="checkbox"/>	<input type="checkbox"/>	<input type="checkbox"/>	<input type="checkbox"/>	<input type="checkbox"/>
17	<input checked="" type="checkbox"/>	500	kbps	<input type="checkbox"/>	<input type="checkbox"/>	<input type="checkbox"/>	<input type="checkbox"/>	<input type="checkbox"/>	<input type="checkbox"/>	<input type="checkbox"/>
18	<input checked="" type="checkbox"/>	500	kbps	<input type="checkbox"/>	<input type="checkbox"/>	<input type="checkbox"/>	<input type="checkbox"/>	<input type="checkbox"/>	<input type="checkbox"/>	<input type="checkbox"/>
19	<input checked="" type="checkbox"/>	500	kbps	<input type="checkbox"/>	<input type="checkbox"/>	<input type="checkbox"/>	<input type="checkbox"/>	<input type="checkbox"/>	<input type="checkbox"/>	<input type="checkbox"/>
20	<input checked="" type="checkbox"/>	500	kbps	<input type="checkbox"/>	<input type="checkbox"/>	<input type="checkbox"/>	<input type="checkbox"/>	<input type="checkbox"/>	<input type="checkbox"/>	<input type="checkbox"/>

Save Reset

Rate: Indicate the rate for the ingress queue policer. By default, 500kbps is used. Allowed range for kbps is 100 to 1000000. Allowed range for Mbps is 1 to 3300Mbps.

Unit: Select the unit of measure for the ingress queue policer.

Save: Save the current running configurations to memory.

Reset: Clear all selected settings.

4.20.5 Port Scheduler

QoS Egress Port Schedulers										
Port	Mode	Weight								
		Q0	Q1	Q2	Q3	Q4	Q5	Q6	Q7	
1	Strict Priority	-	-	-	-	-	-	-	-	-
2	Strict Priority	-	-	-	-	-	-	-	-	-
3	Strict Priority	-	-	-	-	-	-	-	-	-
4	Strict Priority	-	-	-	-	-	-	-	-	-
5	Strict Priority	-	-	-	-	-	-	-	-	-
6	Strict Priority	-	-	-	-	-	-	-	-	-
7	Strict Priority	-	-	-	-	-	-	-	-	-
8	Strict Priority	-	-	-	-	-	-	-	-	-
9	Strict Priority	-	-	-	-	-	-	-	-	-
10	Strict Priority	-	-	-	-	-	-	-	-	-
11	Strict Priority	-	-	-	-	-	-	-	-	-
12	Strict Priority	-	-	-	-	-	-	-	-	-
13	Strict Priority	-	-	-	-	-	-	-	-	-
14	Strict Priority	-	-	-	-	-	-	-	-	-
15	Strict Priority	-	-	-	-	-	-	-	-	-
16	Strict Priority	-	-	-	-	-	-	-	-	-
17	Strict Priority	-	-	-	-	-	-	-	-	-
18	Strict Priority	-	-	-	-	-	-	-	-	-
19	Strict Priority	-	-	-	-	-	-	-	-	-
20	Strict Priority	-	-	-	-	-	-	-	-	-

Port: Click the port to set up detailed settings for port scheduler.

Mode: Display scheduler mode selected.

Weight: Display the weight in percentage assigned to Q0~Q7.

QoS Egress Port Scheduler and Shapers Port 1

Scheduler Mode: Strict Priority

	Queue Shaper				Queue Scheduler		Port Shaper			
	Enable	Rate	Unit	Rate-type	Cut-through		Enable	Rate	Unit	Rate-type
Q7	<input type="checkbox"/>	500	kbps	Line	<input type="checkbox"/>		<input type="checkbox"/>	500	kbps	Line
Q6	<input type="checkbox"/>	500	kbps	Line	<input type="checkbox"/>		<input type="checkbox"/>	500	kbps	Line
Q5	<input type="checkbox"/>	500	kbps	Line	<input type="checkbox"/>		<input type="checkbox"/>	500	kbps	Line
Q4	<input type="checkbox"/>	500	kbps	Line	<input type="checkbox"/>		<input type="checkbox"/>	500	kbps	Line
Q3	<input type="checkbox"/>	500	kbps	Line	<input type="checkbox"/>		<input type="checkbox"/>	500	kbps	Line
Q2	<input type="checkbox"/>	500	kbps	Line	<input type="checkbox"/>		<input type="checkbox"/>	500	kbps	Line
Q1	<input type="checkbox"/>	500	kbps	Line	<input type="checkbox"/>		<input type="checkbox"/>	500	kbps	Line
Q0	<input type="checkbox"/>	500	kbps	Line	<input type="checkbox"/>		<input type="checkbox"/>	500	kbps	Line

Diagram: A large vertical oval labeled 'STRICT' is connected to queues Q0-Q7. A Port Shaper is also connected to the output of the STRICT scheduler.

Buttons: Save, Reset, Back

QoS Egress Port Scheduler and Shapers Port 1

Scheduler Mode: 4 Queues Weighted

	Queue Shaper				Queue Scheduler			Port Shaper			
	Enable	Rate	Unit	Rate-type	Cut-through	Weight	Percent	Enable	Rate	Unit	Rate-type
Q7	<input type="checkbox"/>	500	kbps	Line	<input type="checkbox"/>			<input type="checkbox"/>	500	kbps	Line
Q6	<input type="checkbox"/>	500	kbps	Line	<input type="checkbox"/>			<input type="checkbox"/>	500	kbps	Line
Q5	<input type="checkbox"/>	500	kbps	Line	<input type="checkbox"/>			<input type="checkbox"/>	500	kbps	Line
Q4	<input type="checkbox"/>	500	kbps	Line	<input type="checkbox"/>			<input type="checkbox"/>	500	kbps	Line
Q3	<input type="checkbox"/>	500	kbps	Line	<input type="checkbox"/>	17	25%	<input type="checkbox"/>	500	kbps	Line
Q2	<input type="checkbox"/>	500	kbps	Line	<input type="checkbox"/>	17	25%	<input type="checkbox"/>	500	kbps	Line
Q1	<input type="checkbox"/>	500	kbps	Line	<input type="checkbox"/>	17	25%	<input type="checkbox"/>	500	kbps	Line
Q0	<input type="checkbox"/>	500	kbps	Line	<input type="checkbox"/>	17	25%	<input type="checkbox"/>	500	kbps	Line

Diagram: A large vertical oval labeled 'STRICT' and a smaller vertical oval labeled 'DWRR' are connected to queues Q0-Q7. A Port Shaper is also connected to the output of the STRICT scheduler.

Buttons: Save, Reset, Back

This page allows you to set up the Schedulers and Shapers for a specific port.

Scheduler Mode: The device offers two modes to handle queues.

Strict mode: This gives egress queues with higher priority to be transmitted first before lower priority queues are serviced.

Weight mode: Deficit Weighted Round-Robin (DWRR) queuing which specifies a scheduling weight for each queue. (Options: Strict, Weighted; Default: Strict) DWRR services the queues in a manner similar to WRR, but the

next queue is serviced only when the queue's Deficit Counter becomes smaller than the packet size to be transmitted.

Queue Shaper/Port Shaper/Queue Shaper

Enable: Select the checkbox to enable queue shaper on a certain queue for this selected port.

Rate: Indicate the rate for the queue shaper. By default, 500kbps is used. Allowed range for kbps is 100 to 1000000. Allowed range for Mbps is 1 to 3300Mbps.

Unit: Select the unit of measure for the queue shaper.

Excess: Select the checkbox to allow excess bandwidth.

Queue Schedule

Queue Scheduler: When Scheduler Mode is set to Weighted, the user needs to indicate a relative weight for each queue. DWRR uses a predefined relative weight for each queue that determines the percentage of service time the switch services each queue before moving on to the next queue. This prevents the head-of-line blocking that can occur with strict priority queuing.

Weight: Assign a weight to each queue. This weight sets the frequency at which each queue is polled for service and subsequently affects the response time software applications assigned a specific priority value.

Percent: The weight as a percentage for this queue.

Port Shaper: Set the rate at which traffic can egress this queue.

Enable: Select the checkbox to enable Port shaper.

Rate: Indicate the rate for Port Shaper. By default, 500kbps is used. Allowed range for kbps is 100 to 1000000. Allowed range for Mbps is 1 to 3300Mbps.

Unit: Select the rate of measure

4.20.6 Port Shaping

QoS Egress Port Shapers									
Port	Shapers							Port	
	Q0	Q1	Q2	Q3	Q4	Q5	Q6		Q7
1	-	-	-	-	-	-	-	-	-
2	-	-	-	-	-	-	-	-	-
3	-	-	-	-	-	-	-	-	-
4	-	-	-	-	-	-	-	-	-
5	-	-	-	-	-	-	-	-	-
6	-	-	-	-	-	-	-	-	-
7	-	-	-	-	-	-	-	-	-
8	-	-	-	-	-	-	-	-	-
9	-	-	-	-	-	-	-	-	-
10	-	-	-	-	-	-	-	-	-
11	-	-	-	-	-	-	-	-	-
12	-	-	-	-	-	-	-	-	-
13	-	-	-	-	-	-	-	-	-
14	-	-	-	-	-	-	-	-	-
15	-	-	-	-	-	-	-	-	-
16	-	-	-	-	-	-	-	-	-
17	-	-	-	-	-	-	-	-	-
18	-	-	-	-	-	-	-	-	-
19	-	-	-	-	-	-	-	-	-
20	-	-	-	-	-	-	-	-	-

This displays each port’s queue shaper and port shaper’s rate.

Click the port number to modify or reset queue shaper and port shaper’s rates. See “Port Scheduler” for detailed explanation on each configuration option.

4.20.7 Port Tag Remarking

QoS Egress Port Tag Remarking	
Port	Mode
1	Classified
2	Classified
3	Classified
4	Classified
5	Classified
6	Classified
7	Classified
8	Classified
9	Classified
10	Classified
11	Classified
12	Classified
13	Classified
14	Classified
15	Classified
16	Classified
17	Classified
18	Classified
19	Classified
20	Classified

QoS Egress Port Tag Remarking Port 1	
Tag Remarking Mode	Classified ▾
Save	Reset
Cancel	

QoS Egress Port Tag Remarking Port 1

Tag Remarking Mode: Default

PCP/DEI Configuration

Default PCP: 0
Default DEI: 0

Save Reset Cancel

QoS Egress Port Tag Remarking Port 1

Tag Remarking Mode: Mapped

(QoS class, DP level) to (PCP, DEI) Mapping

QoS class	DP level	PCP	DEI
*	*	0	0
0	0	1	0
0	1	1	1
1	0	0	0
1	1	0	1
2	0	2	0
2	1	2	1
3	0	3	0
3	1	3	1
4	0	4	0
4	1	4	1
5	0	5	0
5	1	5	1
6	0	6	0
6	1	6	1
7	0	7	0
7	1	7	1

Save Reset Cancel

Tag Remarking Mode: Select the appropriate remarking mode used by this port.

Classified: Use classified PCP/DEI values.

Default: Use default PCP/DEI values (Default PCP:0; Default DEI:0).

Mapped: Use the mapping of the classified QoS class values and DP levels to PCP/DEI values.

QoS class/DP level: Show the mapping options for QoS class values and DP levels (drop precedence).

PCP: Remarks matching egress frames with the specified Priority Code Point (or User Priority) value. (Range: 0~7; Default: 0)

DEI: Remarks matching egress frames with the specified Drop Eligible Indicator. (Range: 0~1; Default: 0)

4.20.8 Port DSCP

QoS Port DSCP Configuration

Port	Ingress		Egress
	Translate	Classify	Rewrite
*	<input type="checkbox"/>	<>	<>
1	<input type="checkbox"/>	Disable	Disable
2	<input type="checkbox"/>	Disable	Disable
3	<input type="checkbox"/>	Disable	Disable
4	<input type="checkbox"/>	Disable	Disable
5	<input type="checkbox"/>	Disable	Disable
6	<input type="checkbox"/>	Disable	Disable
7	<input type="checkbox"/>	Disable	Disable
8	<input type="checkbox"/>	Disable	Disable
9	<input type="checkbox"/>	Disable	Disable
10	<input type="checkbox"/>	Disable	Disable
11	<input type="checkbox"/>	Disable	Disable
12	<input type="checkbox"/>	Disable	Disable
13	<input type="checkbox"/>	Disable	Disable
14	<input type="checkbox"/>	Disable	Disable
15	<input type="checkbox"/>	Disable	Disable
16	<input type="checkbox"/>	Disable	Disable
17	<input type="checkbox"/>	Disable	Disable
18	<input type="checkbox"/>	Disable	Disable
19	<input type="checkbox"/>	Disable	Disable
20	<input type="checkbox"/>	Disable	Disable
21	<input type="checkbox"/>	Disable	Disable
22	<input type="checkbox"/>	Disable	Disable
23	<input type="checkbox"/>	Disable	Disable
24	<input type="checkbox"/>	Disable	Disable

Save Reset

Port: The port number. "Port *" settings apply to all ports.

Ingress Translate: Select the checkbox to enable ingress translation of DSCP values based on the selected classification method.

Ingress Classify: Select the appropriate classification method:

Disable: No ingress DSCP classification is performed.

DSCP=0: Classify if incoming DSCP is 0.

Selected: Classify only selected DSCP for which classification is enabled in DSCP Translation table.

All: Classify all DSCP.

Egress Rewrite: Configure port egress rewriting of DSCP values.

Disable: Egress rewriting is disabled.

Enable: Enable egress rewriting is enabled but with remapping.

Remap DP aware: Frame with DSCP from analyzer is remapped and remarked with the remapped DSCP value. Depending on the frame's DP level, the remapped DSCP value is either taken from the DSCP Translation table, Egress Remap DPO or DP1 field.

Remap DP unaware: Frame with DSCP from analyzer is remapped and remarked with the remapped DSCP value. The remapped DSCP value is always taken from the DSCP Translation table, Egress Remap DPO field.

4.20.9 DSCP-Based QoS

DSCP-Based QoS Ingress Classification			
DSCP	Trust	QoS Class	DPL
*	<input type="checkbox"/>	< >	< >
0 (BE)	<input type="checkbox"/>	0	0
1	<input type="checkbox"/>	0	0
2	<input type="checkbox"/>	0	0
3	<input type="checkbox"/>	0	0
4	<input type="checkbox"/>	0	0
5	<input type="checkbox"/>	0	0
6	<input type="checkbox"/>	0	0
7	<input type="checkbox"/>	0	0
8 (CS1)	<input type="checkbox"/>	0	0
9	<input type="checkbox"/>	0	0
10 (AF11)	<input type="checkbox"/>	0	0
11	<input type="checkbox"/>	0	0
12 (AF12)	<input type="checkbox"/>	0	0
13	<input type="checkbox"/>	0	0
14 (AF13)	<input type="checkbox"/>	0	0
15	<input type="checkbox"/>	0	0
16 (CS2)	<input type="checkbox"/>	0	0
17	<input type="checkbox"/>	0	0
18 (AF21)	<input type="checkbox"/>	0	0
19	<input type="checkbox"/>	0	0
20 (AF22)	<input type="checkbox"/>	0	0
21	<input type="checkbox"/>	0	0
22 (AF23)	<input type="checkbox"/>	0	0
23	<input type="checkbox"/>	0	0
24 (CS3)	<input type="checkbox"/>	0	0
25	<input type="checkbox"/>	0	0
26 (AF31)	<input type="checkbox"/>	0	0
27	<input type="checkbox"/>	0	0

DSCP: DSCP value in ingress packet. DSCP range is from 0 to 63.

Trust: Select the checkbox to indicate that DSCP value is trusted. Only trusted DSCP values are mapped to a specific QoS class and drop precedence level (DPL). Frames with untrusted DSCP values are treated as non-IP frames.

QoS Class: Select the QoS class to the corresponding DSCP value for ingress processing. By default, 0 is used. Allowed range is 0 to 7.

DPL: Select the drop precedence level to the corresponding DSCP value for ingress processing. By default, 0 is used. The value "1" has the higher drop priority.

4.20.10 DSCP Translation

DSCP Translation			
DSCP	Ingress		Egress
	Translate	Classify	Remap
*	<>	<input type="checkbox"/>	<>
0 (BE)	0 (BE)	<input type="checkbox"/>	0 (BE)
1	1	<input type="checkbox"/>	1
2	2	<input type="checkbox"/>	2
3	3	<input type="checkbox"/>	3
4	4	<input type="checkbox"/>	4
5	5	<input type="checkbox"/>	5
6	6	<input type="checkbox"/>	6
7	7	<input type="checkbox"/>	7
8 (CS1)	8 (CS1)	<input type="checkbox"/>	8 (CS1)
9	9	<input type="checkbox"/>	9
10 (AF11)	10 (AF11)	<input type="checkbox"/>	10 (AF11)
11	11	<input type="checkbox"/>	11
12 (AF12)	12 (AF12)	<input type="checkbox"/>	12 (AF12)
13	13	<input type="checkbox"/>	13
14 (AF13)	14 (AF13)	<input type="checkbox"/>	14 (AF13)
15	15	<input type="checkbox"/>	15
16 (CS2)	16 (CS2)	<input type="checkbox"/>	16 (CS2)
17	17	<input type="checkbox"/>	17
18 (AF21)	18 (AF21)	<input type="checkbox"/>	18 (AF21)
19	19	<input type="checkbox"/>	19
20 (AF22)	20 (AF22)	<input type="checkbox"/>	20 (AF22)
21	21	<input type="checkbox"/>	21
22 (AF23)	22 (AF23)	<input type="checkbox"/>	22 (AF23)

DSCP: DSCP value in ingress packet. DSCP range is from 0 to 63.

Ingress Translate: Enable Ingress Translation of DSCP values based on the specified classification method.

Ingress Classify: Enable classification at ingress side as defined in the QoS port DSCP Configuration Table.

Egress Remap: Remap DP value to the selected DSCP value.

4.20.11 DSCP Classification

DSCP Classification				
CoS	DSCP DP0	DSCP DP1	DSCP DP2	DSCP DP3
*	<>	<>	<>	<>
0	0 (BE)	0 (BE)	0 (BE)	0 (BE)
1	0 (BE)	0 (BE)	0 (BE)	0 (BE)
2	0 (BE)	0 (BE)	0 (BE)	0 (BE)
3	0 (BE)	0 (BE)	0 (BE)	0 (BE)
4	0 (BE)	0 (BE)	0 (BE)	0 (BE)
5	0 (BE)	0 (BE)	0 (BE)	0 (BE)
6	0 (BE)	0 (BE)	0 (BE)	0 (BE)
7	0 (BE)	0 (BE)	0 (BE)	0 (BE)

Save Reset

Map DSCP values to QoS class and DPL value.

QoS Class: List of actual QoS class values.

DSCP DP0: Select the classified DSCP value (0~63) to map Drop Precedence Level 0.

DSCP DP1: Select the classified DSCP value (0~63) to map Drop Precedence Level 1.

DSCP DP2: Select the classified DSCP value (0~63) to map Drop Precedence Level 2.

DSCP DP3: Select the classified DSCP value (0~63) to map Drop Precedence Level 3.

4.20.12 Ingress Map Configuration

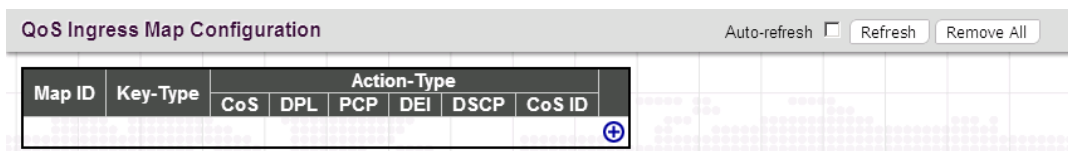

This page allows to edit or create a single QoS Ingress Map entry at a time. Each entry has a key and an action. The key indicates which fields of the frame will be mapped to the fields specified by and according to the action. Each Map can hold a number of map rules, or mappings between possible keys and actions. Which of those rules will be applied depends on the selection of (Key-Type, Action-Type).

Click **+** to create a new Ingress Map entry.

Ingress Map Configuration

Ingress Map ID

MAP ID

Ingress Map Key

Map Key

Ingress Map Action

CoS	Disabled ▼
DPL	Disabled ▼
PCP	Disabled ▼
DEI	Disabled ▼
DSCP	Disabled ▼
CoS ID	Disabled ▼

Map ID: Indicates the Map (unique) ID. The allowed range is 0 to 255. When in edit mode, this is non-configurable. However, it is possible to overwrite an existing mapping through the create mode.

Map Key: Indicates the Key type that will be used to filter the map rules when applying the map. As mentioned above, map rules can have various keys and this is to make a select set of them. Possible Key types are:

PCP: Use PCP as key for tagged frames and none for the rest.

PCP - DEI: Use PCP/DEI as key for tagged frames and none for the rest.

DSCP: Use DSCP as key for IP frames and none for the rest.

DSCP - PCP - DEI: Use DSCP as key for IP frames, PCP/DEI for tagged frames and none for the rest.

Map Action: Indicates the Action type that will be used to filter the map rules when applying the map. As mentioned above, map rules can have various actions available and this is to make a select set of them. Possible Action types are:

CoS: Class of Service.

DPL: Drop Precedence Level.

PCP: Priority Code Point.

DEI: Drop Eligible Indicator.

DSCP: Differentiated Services Code Point.

CoS ID: CoS ID.

4.20.13 Egress Map Configuration

QoS Egress Map Configuration					
Map ID	Key-Type	Action-Type			
		PCP	DEI	DSCP	
					+

This page allows to edit or create a single QoS Egress Map entry at a time. Each entry has a key and an action. The key indicates which fields of the frame will be mapped to the fields specified by and according to the action. Each Map can hold a number of map rules, or mappings between possible keys and actions. Which of those rules will be applied depends on the selection of (Key-Type, Action-Type).

Click  to create a new Egress Map instance.

Map ID: Indicates the Map (unique) ID. The allowed range is 0 to 511. When in edit mode, this is non-configurable. However, it is possible to overwrite an existing mapping through the create mode.

Map Key: Indicates the Key type that will be used to filter the map rules when applying the map. As mentioned above, map rules can have various keys and this is to make a select set of them. Possible Key types are:

CoS ID: Use classified COS ID as key.

CoS ID - DPL: Use classified COS ID and DPL as key.

DSCP: Use classified DSCP as key.

DSCP - DPL: Use classified DSCP and DPL as key.

Map Action: Indicates the Action type that will be used to filter the map rules when applying the map. As mentioned above, map rules can have various actions available and this is to make a select set of them. Possible Action types are:

PCP: Priority Code Point.

DEI: Drop Eligible Indicator.

DSCP: Differentiated Services Code Point.

4.20.14 QoS Control List

Quality of Service control list is used to establish policies for handling ingress packets based on frame type, MAC address, VID, PCP, DEI values. Once a QCE is mapped to a port, traffic matching the first entry in the QoS Control List is assigned to the QoS class, drop precedence level, and DSCP value defined by that entry. Traffic not matching any of the QCEs are classified to the default QoS Class for the port.

QoS Control List Configuration															
QCE	Port	DMAC	SMAC	Tag Type	VID	PCP	DEI	Frame Type	Action						
									CoS	DPL	DSCP	PCP	DEI	Policy	Ingress Map

This page displays rules created in QoS control list (QCL) only. The maximum number of QCL is 256 on this device.

QCE#: Display Quality Control Entry index.

Port: Display the port number that uses this QCL.

Frame Type: Display the frame type to look for in incoming frames. Possible frame types are Any, Ethernet, LLC SNAP, IPv4, IPv6.

SMAC: Source MAC address.

DMAC: Destination MAC address. Possible values are Any, Broadcast, Multicast, Unicast.

VID: Display VLAN ID (1~4095)

PCP: Display PCP value.

DEI: Display DEI value.

Action: Display the classification action taken on ingress frames when the configured parameters are matched in the frame's content. If a frame matches the QCL, the following actions will be taken.

Class: If a frame matches the QCL, it will be put in the queue corresponding to the specified QoS class.

DPL: The drop precedence level will be set to the specified value.

DSCP: The DSCP value will be set to the specified value.

PCP: (0-7) or 'Default'. Note: PCP and DEI cannot be set individually.

DEI: (0-1) or 'Default'.

VID: Add this value to the current classified VID.

Pop: The ingress tag pop count (0~2) or 'Default'.

Policy: (0-127) or 'Default' (empty field).

Ingress Map: (0-255) or no Ingress Map (empty field).

You can modify each QCE (QoS Control Entry) in the table using the following buttons:

: Inserts a new QCE before the current row.

: Edits the QCE row.

: Moves the QCE up the list.

- ⬇️: Moves the QCE down the list.
- ✖️: Deletes the QCE.
- ⊕: The lowest plus sign adds a new entry at the bottom of the QCE listings.

Once  is clicked in display page, the following page will appear.

QCE Configuration

Port Members: Select ports that use this rule.

Key Parameters

Tag: Select VLAN tag type (Tag or Untag). By default, any type is used.

VID: Select VID preference. By default, any VID is used. Select “Specific”, if you would like to designate a VID to this QCL entry. Or Select “Range”, if you would like to map a range of VIDs to this QCL entry.

PCP: Select a PCP value (either specific value or a range of values are provided). By default, any is used.

DEI: Select a DEI value. By default, any is used.

SMAC: Select source MAC address type. By default, any is used. Select “Specific” to specify a source MAC (first three bytes of the MAC address or OUI).

DMAC Type: Select destination MAC address type. By default, any is used. Other options available are “UC” for unicast, “MC” for multicast, and “BC” for broadcast.

Inner Tag: The Inner Tag field can be 'Untagged', 'Tagged', 'C-Tagged', 'S-Tagged' or 'Any'.

Inner VID: The Inner VLAN ID can be any value in the range 1-4095 or 'Any'; user can enter either a specific value or a range of VIDs.

Inner PCP: Inner PCP are specific (0, 1, 2, 3, 4, 5, 6, 7) or range (0-1, 2-3, 4-5, 6-7, 0-3, 4-7) or 'Any'.

Inner DEI: Inner DEI can be '0', '1' or 'Any'.

Frame Type: The frame types can be selected are listed below.

Any: By default, any is used which means that all types of frames are allowed.

Ethernet: This option can only be used to filter Ethernet II formatted packets. (Options: Any, Specific – 600-ffff hex; Default: ffff). Note that 800 (IPv4) and 86DD (IPv6) are excluded. A detailed listing of Ethernet protocol types can be found in RFC 1060. A few of the more common types include 0800 (IP), 0806 (ARP), 8137 (IPX).

LLC: LLC refers to Link Logical Control and further provides three options.

SSAP: SSAP stands for Source Service Access Point address. By default, any is used. Select specific to indicate a value (0x00 - 0xFF).

DSAP: DSAP stands for Destination Service Access Point address. By default, any is used. Select specific to indicate a value (0x00 to 0xFF).

Control: Control field may contain command, response, or sequence information depending on whether the LLC frame type is Unnumbered, Supervisory, or Information. By default, any is used. Select specific to indicate a value (0x00 to 0xFF).

SNAP: SubNetwork Access Protocol can be distinguished by an OUI and a Protocol ID. (Options for PID: Any, Specific (0x00-0xffff); Default: Any) If the OUI is hexadecimal 000000, the protocol ID is the Ethernet type (EtherType) field value for the protocol running on top of SNAP. If the OUI is that of a particular organization, the protocol ID is a value assigned by that organization to the protocol running on top of SNAP. In other words, if value of the OUI field is 00-00-00, then value of the PID will be etherType (0x0600-0xffff), and if value of the OUI is other than 00-00-00, then valid value of the PID will be any value from 0x0000 to 0xffff.

IPv4:

Protocol: IPv4 frame type includes Any, TCP, UDP, Other. If “TCP” or “UDP” is selected, you might further define Sport (Source port number) and Dport (Destination port number).

Source IP: Select source IP type. By default, any is used. Select “Specific” to indicate self-defined source IP and submask format. The address and mask must be in the format x.y.z.w where x, y, z, and w are decimal numbers between 0 and 255. When the mask is converted to a 32-bit binary string and read from left to right, all bits following the first zero must also be zero

IP Fragment: By default, any is used. Datagrams sometimes may be fragmented to ensure they can pass through a network device that uses a maximum transfer unit smaller than the original packet’s size.

DSCP: By default, any is used. Select “Specific” to indicate a DSCP value. Select “Range” to indicate a range of DSCP value.

IPv6:

Protocol: IPv6 protocol includes Any, TCP, UDP, Other. If “TCP” or “UDP” is selected, you may need to further define Sport (Source port number) and Dport (Destination port number).

Source IP: Select source IP type. By default, any is used. Select “Specific” to indicate self-defined source IP and submask format.

DSCP: By default, any is used. Select “Specific” to indicate a DSCP value. Select “Range” to indicate a range of DSCP value.

Action Parameters

Specify the classification action taken on ingress frame if the parameters match the frame’s content. The actions taken include the following:

Class: If a frame matches the QCE, it will be put in the queue corresponding to the specified QoS class or placed in a queue based on basic classification rules.

DPL: If a frame matches the QCE, the drop precedence level will be set to the selected value or left unchanged.

DSCP: If a frame matches the QCE, the DSCP value will be set to the selected one.

PCP: If a frame matches the QCE, the PCP value will be set to the selected one.

DEI: If a frame matches the QCE, the DEI value will be set to the selected one.

VID: If a frame matches the QCE, the VID will be set to the selected one.

Tag Pop Count: If a frame matches the QCE, the Tag Pop Count value will be set to the selected one.

Policy: If a frame matches the QCE, the policy ID specified will be applied.

Ingress Map ID: If a frame matches the QCE, the ingress map ID specified will be applied.

4.20.15 Storm Policing

Storm Policing is used to keep a network from downgraded performance or a complete halt by setting up a threshold for traffic like broadcast, unicast and multicast. When a device on the network is malfunctioning or application programs are not well designed or properly configured, storms may occur and will degrade network performance or even cause a complete halt. The network can be protected from storms by setting a threshold for specified traffic on the device. Any specified packets exceeding the specified threshold will then be dropped.

Global Storm Policer Configuration			
Frame Type	Enable	Rate	Unit
Unicast	<input type="checkbox"/>	1	pps
Multicast	<input type="checkbox"/>	1	pps
Broadcast	<input type="checkbox"/>	1	pps

Save Reset

Enable: Enable Unicast storm, Multicast storm or Broadcast storm protection.

Rate (pps): Select the packet threshold. The packets received exceed the selected value will be dropped.

Unit: Select the unit for each frame type.

Port Storm Policer Configuration											
Port	Unicast Frames			Broadcast Frames			Unknown Frames				
	Enable	Rate	Unit	Enable	Rate	Unit	Enable	Rate	Unit		
1	<input type="checkbox"/>	500	<>	<input type="checkbox"/>	500	<>	<input type="checkbox"/>	500	<>		
2	<input type="checkbox"/>	500	kbits	<input type="checkbox"/>	500	kbits	<input type="checkbox"/>	500	kbits		
3	<input type="checkbox"/>	500	kbits	<input type="checkbox"/>	500	kbits	<input type="checkbox"/>	500	kbits		
4	<input type="checkbox"/>	500	kbits	<input type="checkbox"/>	500	kbits	<input type="checkbox"/>	500	kbits		
5	<input type="checkbox"/>	500	kbits	<input type="checkbox"/>	500	kbits	<input type="checkbox"/>	500	kbits		
6	<input type="checkbox"/>	500	kbits	<input type="checkbox"/>	500	kbits	<input type="checkbox"/>	500	kbits		
7	<input type="checkbox"/>	500	kbits	<input type="checkbox"/>	500	kbits	<input type="checkbox"/>	500	kbits		
8	<input type="checkbox"/>	500	kbits	<input type="checkbox"/>	500	kbits	<input type="checkbox"/>	500	kbits		
9	<input type="checkbox"/>	500	kbits	<input type="checkbox"/>	500	kbits	<input type="checkbox"/>	500	kbits		
10	<input type="checkbox"/>	500	kbits	<input type="checkbox"/>	500	kbits	<input type="checkbox"/>	500	kbits		
11	<input type="checkbox"/>	500	kbits	<input type="checkbox"/>	500	kbits	<input type="checkbox"/>	500	kbits		
12	<input type="checkbox"/>	500	kbits	<input type="checkbox"/>	500	kbits	<input type="checkbox"/>	500	kbits		
13	<input type="checkbox"/>	500	kbits	<input type="checkbox"/>	500	kbits	<input type="checkbox"/>	500	kbits		
14	<input type="checkbox"/>	500	kbits	<input type="checkbox"/>	500	kbits	<input type="checkbox"/>	500	kbits		
15	<input type="checkbox"/>	500	kbits	<input type="checkbox"/>	500	kbits	<input type="checkbox"/>	500	kbits		
16	<input type="checkbox"/>	500	kbits	<input type="checkbox"/>	500	kbits	<input type="checkbox"/>	500	kbits		
17	<input type="checkbox"/>	500	kbits	<input type="checkbox"/>	500	kbits	<input type="checkbox"/>	500	kbits		
18	<input type="checkbox"/>	500	kbits	<input type="checkbox"/>	500	kbits	<input type="checkbox"/>	500	kbits		
19	<input type="checkbox"/>	500	kbits	<input type="checkbox"/>	500	kbits	<input type="checkbox"/>	500	kbits		
20	<input type="checkbox"/>	500	kbits	<input type="checkbox"/>	500	kbits	<input type="checkbox"/>	500	kbits		

There is a storm policer for known and unknown unicast frames, known and unknown broadcast frames and unknown (flooded) unicast, multicast and broadcast frames.

Port: The port number for which the configuration below applies.

Enable: Enable (Tick the checkbox) or disable (uncheck) the storm policer for this switch port.

Rate: Controls the rate for the port storm policer. This value is restricted to 10-13128147 when "Unit" is fps or kbps, and 1-13128 when "Unit" is kfps or Mbps. The rate is internally rounded up to the nearest value supported by the port storm policer. Supported rates are divisible by 10 fps or 25 kbps.

Unit: Controls the unit of measure for the port storm policer rate as fps, kfps, kbps or Mbps.

4.20.16 QCL Status

This page shows the QCL status by different QCL users.

QoS Control List Status															
												Combined	Auto-refresh <input type="checkbox"/>	Resolve Conflict	Refresh
User	QCE	Ingress Port	Frame Type	Action									Conflict		
				CoS	DPL	DSCP	PCP	DEI	VID	Pop	Policy	Ingress Map			
No entries															

Each row describes the QCE that is defined. It is a conflict if a specific QCE is not applied to the hardware due to hardware limitations. The maximum number of QCEs is 256 on each switch.

User: Indicates the QCL user.

QCE#: Indicates the index of QCE.

Port: Indicates the list of ports configured with the QCE.

Frame Type: Indicates the type of frame to look for incoming frames. Possible frame types are:

Any: The QCE will match all frame type.

Ethernet: Only Ethernet frames (with Ether Type 0x600-0xFFFF) are allowed.

LLC: Only (LLC) frames are allowed.

SNAP: Only (SNAP) frames are allowed.

IPv4: The QCE will match only IPV4 frames.

IPv6: The QCE will match only IPV6 frames.

Action: Indicates the classification action taken on ingress frame if parameters configured are matched with the frame's content.

CoS: Classified QoS class; if a frame matches the QCE it will be put in the queue.

DPL: Drop Precedence Level; if a frame matches the QCE then DP level will set to value displayed under DPL column.

DSCP: If a frame matches the QCE then DSCP will be classified with the value displayed under DSCP column.

PCP: Classify Priority Code Point value.

DEI: Classify Drop Eligible Indicator value.

VLAN: Classify VLAN ID value.

Tag Pop: Tag pop count.

Policy: Classify ACL policy number.

Ingress Map: Classify Ingress Map ID.

Conflict: Displays Conflict status of QCL entries. As H/W resources are shared by multiple applications, it may happen that resources required to add a QCE may not be available. In that case it shows conflict status as 'Yes', otherwise it is always 'No'. Please note that conflict can be resolved by releasing the H/W resources required to add QCL entry on pressing 'Resolve Conflict' button.

4.20.17 Detailed Statistics

This page provides detailed traffic statistics for a specific switch port. The displayed counters are the totals for receive and transmit, the size counters for receive and transmit, and the error counters for receive and transmit. Use the port select pull down to select which switch port details to display.

Detailed Port Statistics Port 1			
Port 1		Auto-refresh <input type="checkbox"/>	Refresh Clear
Receive Total		Transmit Total	
Rx Packets	0	Tx Packets	0
Rx Octets	0	Tx Octets	0
Rx Unicast	0	Tx Unicast	0
Rx Multicast	0	Tx Multicast	0
Rx Broadcast	0	Tx Broadcast	0
Rx Pause	0	Tx Pause	0
Receive Size Counters		Transmit Size Counters	
Rx 64 Bytes	0	Tx 64 Bytes	0
Rx 65-127 Bytes	0	Tx 65-127 Bytes	0
Rx 128-255 Bytes	0	Tx 128-255 Bytes	0
Rx 256-511 Bytes	0	Tx 256-511 Bytes	0
Rx 512-1023 Bytes	0	Tx 512-1023 Bytes	0
Rx 1024-1526 Bytes	0	Tx 1024-1526 Bytes	0
Rx 1527- Bytes	0	Tx 1527- Bytes	0
Receive Queue Counters		Transmit Queue Counters	
Rx Q0	0	Tx Q0	0
Rx Q1	0	Tx Q1	0
Rx Q2	0	Tx Q2	0
Rx Q3	0	Tx Q3	0
Rx Q4	0	Tx Q4	0
Rx Q5	0	Tx Q5	0
Rx Q6	0	Tx Q6	0
Rx Q7	0	Tx Q7	0
Receive Error Counters		Transmit Error Counters	
Rx Drops	0	Tx Drops	0
Rx CRC/Alignment	0	Tx Late/Exc. Coll.	0
Rx Undersize	0		
Rx Oversize	0		
Rx Fragments	0		
Rx Jabber	0		
Rx Filtered	0		

Receive Total and Transmit Total

Rx and Tx Packets: The number of received and transmitted (good and bad) packets.

Rx and Tx Octets: The number of received and transmitted (good and bad) bytes. Includes FCS, but excludes framing bits.

Rx and Tx Unicast: The number of received and transmitted (good and bad) unicast packets.

Rx and Tx Multicast: The number of received and transmitted (good and bad) multicast packets.

Rx and Tx Broadcast: The number of received and transmitted (good and bad) broadcast packets.

Rx and Tx Pause: A count of the MAC Control frames received or transmitted on this port that have an opcode indicating a PAUSE.

Receive and Transmit Size Counters

Rx 64~1527 Bytes & Tx 64~1527 Bytes: Displays the number of received and transmitted (good and bad) packets split into categories based on their respective frame sizes.

Receive and Transmit Queue Counters

Rx Q0~Q7 & Tx Q0~Q7: Displays the number of received and transmitted packets per input and output queue.

Receive Error Counters

Rx Drops: The number of frames dropped due to lack of receive buffers or egress congestion.

Rx CRC/Alignment: The number of frames received with CRC or alignment errors.

Rx Undersize: The number of short ¹ frames received with valid CRC.

Rx Oversize: The number of long ² frames received with valid CRC.

Rx Fragments: The number of short ¹ frames received with invalid CRC.

Rx Jabber: The number of long ² frames received with invalid CRC.

Rx Filtered: The number of received frames filtered by the forwarding process.

¹ Short frames are frames that are smaller than 64 bytes.

² Long frames are frames that are longer than the configured maximum frame length for this port.

Transmit Error Counters

Tx Drops: The number of frames dropped due to output buffer congestion.

Tx Late/Exc. Coll.: The number of frames dropped due to excessive or late collisions.

4.21 Mirroring

Mirroring is a feature for switched port analyzer. The administrator can use the Mirroring to debug network problems. The selected traffic can be mirrored or copied on a destination port where a network analyzer can be attached to analyze the network traffic.

If you want to get the tagged mirrored traffic, you have to set VLAN egress tagging as "Tag All" on the reflector port. On the other hand, if you want to get untagged mirrored traffic, you have to set VLAN egress tagging as "Untag ALL" on the reflector port.

Session ID	Mode	Type	VLAN ID	Reflector Port
1	Disabled	Mirror	-	-
2	Disabled	Mirror	-	-
3	Disabled	Mirror	-	-
4	Disabled	Mirror	-	-
5	Disabled	Mirror	-	-

Session ID: Select session id to configure.

Mode: Enable or disable the mirror or Remote Mirroring function.

Type: Select switch type.

Mirror: The switch is running on mirror mode. The source port(s) and destination port are located on this switch.

RMirror source: This option is for Remote Mirroring (RSPAN) application. The switch is a source node for monitor flow. The source port(s), reflector port are located on this switch.

RMirror destination: This option is for Remote Mirroring (RSPAN) application. The switch is an end node for monitor flow. The destination port(s) is located on this switch.

VLAN ID: The VLAN ID points out where the monitor packet will copy to. The default VLAN ID is 200.

Reflector Port: The reflector port is a method to redirect the traffic to Remote Mirroring VLAN. Any device connected to a port set as a reflector port loses connectivity until the Remote Mirroring is disabled.

If you shut down a port, it cannot be a candidate for reflector port.

If you shut down the port which is a reflector port, the remote mirror function cannot work.

Note1: The reflector port needs to select only on Source switch type.

Note2: The reflector port needs to disable MAC Table learning and STP.

Note3: The reflector port only supports on pure copper ports.

Mirror & RMirror Configuration

Global Settings

Session ID	1
Mode	Disabled
Type	Mirror
VLAN ID	200
ReflectorPort	Port 25

Source VLAN(s) Configuration

VLAN ID

Port Configuration

Port	Source	Destination
*	<>	<input type="checkbox"/>
Port 1	Disabled	<input type="checkbox"/>
Port 2	Disabled	<input type="checkbox"/>
Port 3	Disabled	<input type="checkbox"/>
Port 4	Disabled	<input type="checkbox"/>
Port 5	Disabled	<input type="checkbox"/>
Port 6	Disabled	<input type="checkbox"/>
Port 7	Disabled	<input type="checkbox"/>
Port 8	Disabled	<input type="checkbox"/>
Port 9	Disabled	<input type="checkbox"/>
Port 10	Disabled	<input type="checkbox"/>
Port 11	Disabled	<input type="checkbox"/>
Port 12	Disabled	<input type="checkbox"/>
Port 13	Disabled	<input type="checkbox"/>
Port 14	Disabled	<input type="checkbox"/>
Port 15	Disabled	<input type="checkbox"/>
Port 16	Disabled	<input type="checkbox"/>
Port 17	Disabled	<input type="checkbox"/>
Port 18	Disabled	<input type="checkbox"/>

Port Configuration

Port: The logical port for the settings contained in the same row.

Source: Select mirror mode.

Disabled: Neither frames transmitted nor frames received are mirrored.

Both: Frames received and frames transmitted are mirrored on the Destination port.

Rx only: Frames received on this port are mirrored on the Destination port. Frames transmitted are not mirrored.

Tx only: Frames transmitted on this port are mirrored on the Destination port. Frames received are not mirrored.

Destination: Select destination port. This checkbox is designed for mirror or Remote Mirroring. The destination port is a switched port that you receive a copy of traffic from the source port.

Note1: On mirror mode, the device only supports one destination port.

Note2: The destination port needs to disable MAC Table learning.

4.22 UPnP

UPnP Configuration	
Mode	Disabled
TTL	4
Advertising Duration	100
IP Addressing Mode	Dynamic
Static VLAN Interface ID	1
<input type="button" value="Save"/> <input type="button" value="Reset"/>	

Mode: Enable or disable UPnP operation.

TTL: TTL (Time to live) is used to configure how many steps an UPnP advertisement can travel before it disappears.

Advertising Duration: This defines how often an UPnP advertisement is sent. The duration is carried in Simple Service Discover Protocol (SSDP) packets which informs a control point how often it should receive a SSDP advertisement message from the switch. By default, the advertising duration is set to 100 seconds. However, due to the unreliable nature of UDP, it is recommended to set to the shorter duration since the shorter the duration, the fresher is UPnP status.

IP Addressing Mode: IP addressing mode provides two ways to determine IP address assignment:

Dynamic: Default selection for UPnP. UPnP module helps users choosing the IP address of the switch device. It finds the first available system IP address.

Static: User specifies the IP interface VLAN for choosing the IP address of the switch device.

Static VLAN Interface ID: The index of the specific IP VLAN interface. It will only be applied when IP Addressing Mode is static. Valid configurable values ranges from 1 to 4095. Default value is 1.

4.23 DDMI

4.23.1 Configuration

DDMI Configuration	
Mode	Enabled
<input type="button" value="Save"/> <input type="button" value="Reset"/>	

Mode: Enable or disable DDMI (Digital Diagnostics Monitoring Interface) operation. When enabled, transceiver & DDMI information can be viewed via “Detailed” pages.

4.23.2 Overview

Port	Vendor	Part Number	Serial Number	Revision	Data Code	Transceiver
17	-	-	-	-	-	-
18	-	-	-	-	-	-
19	-	-	-	-	-	-
20	-	-	-	-	-	-

This page displays DDMI overview information.

Port: Shows DDMI port number.

Vendor: Vendor name SFP vendor name.

Part Number: Vendor PN Part number provided by SFP vendor.

Serial Number: Vendor SN Serial number provided by vendor.

Revision: Vendor rev Revision level for part number provided by vendor.

Data Code: Vendor's manufacturing date code.

Transceiver: Shows transceiver compatibility.

4.23.3 Detailed

Transceiver Information						
Vendor	CTC UNION					
Part Number	SFS-7050-Z55-DD					
Serial Number	FC1609032024					
Revision	A1					
Data Code	2016-08-1901					
Transceiver	1000BASE_LX					

DDMI Information						
++ : high alarm, + : high warning, - : low warning, -- : low alarm Tx: transmit, Rx: receive, mA: milliamperes, mW: milliwatts						
Type	Current	High Alarm Threshold	High Warn Threshold	Low Warn Threshold	Low Alarm Threshold	
Temperature(C)	35.410	-1.000	85.000	-40.000	-45.000	
Voltage(V)	3.2051	3.8000	3.6000	2.9700	2.8000	
Tx Bias(mA)	21.804	80.000	70.000	0.000	0.000	
Tx Power(mW)	0.5698	2.5119	1.9953	0.1995	0.1585	
Rx Power(mW)	0.6414 +	0.7943	0.5012	0.0019	0.0012	

This page displays DDMI detailed information.

Transceiver Information

Vendor: Vendor name SFP vendor name.

Part Number: Vendor PN Part number provided by SFP vendor.

Serial Number: Vendor SN Serial number provided by vendor.

Revision: Vendor rev Revision level for part number provided by vendor.

Data Code: Date code Vendor's manufacturing date code.

Transceiver: Shows transceiver compatibility.

DDMI Information

Current: The current value of temperature, voltage, TX bias, TX power, and RX power.

High Alarm Threshold: The high alarm threshold value of temperature, voltage, TX bias, TX power, and RX power.

High Warn Threshold: The high warn threshold value of temperature, voltage, TX bias, TX power, and RX power.

Low Warn Threshold: The low warn threshold value of temperature, voltage, TX bias, TX power, and RX power.

Low Alarm Threshold: The low alarm threshold value of temperature, voltage, TX bias, TX power, and RX power.

4.24 L2CP

L2CP stands for Layer 2 Control Protocol and contains Ethernet control protocols such as Spanning Tree BPDUs, LACP, Pause frames, etc. A L2CP frame has a specific destination address (DA) belonging to reserved multicast MAC address ranges. MEF defines L2CP processing rules for Ethernet Frames carrying a MAC destination address (DA) within the range of 01-80-C2-00-00-00 through 01-80-C2-00-00-0F and 01-80-C2-00-00-20 through 01-80-C2-00-00-2F. Therefore, if a vendor defines L2CP frames outside the specified MAC DA ranges, the L2CP handling rules do not apply to these frames.

L2CP Port Configuration	
DMAC	L2CP Mode
*	⊞
01-80-C2-00-00-00	Peer
01-80-C2-00-00-01	Peer
01-80-C2-00-00-02	Peer
01-80-C2-00-00-03	Peer
01-80-C2-00-00-04	Peer
01-80-C2-00-00-05	Peer
01-80-C2-00-00-06	Peer
01-80-C2-00-00-07	Peer
01-80-C2-00-00-08	Peer
01-80-C2-00-00-09	Peer
01-80-C2-00-00-0A	Peer
01-80-C2-00-00-0B	Peer
01-80-C2-00-00-0C	Peer
01-80-C2-00-00-0D	Peer
01-80-C2-00-00-0E	Peer
01-80-C2-00-00-0F	Peer
01-80-C2-00-00-10	Forward
01-80-C2-00-00-20	Forward
01-80-C2-00-00-21	Forward
01-80-C2-00-00-22	Forward
01-80-C2-00-00-23	Forward
01-80-C2-00-00-24	Forward

DMAC: The destination MAC address. The MAC DA range for Bridge block of protocol is 01-80-C2-00-00-00 through 01-80-C2-00-00-0F and for GARP block of protocol is 01-80-C2-00-00-20 through 01-80-C2-00-00-2F.

L2CP Mode: Select the L2CP frame handling mode for the corresponding destination MAC address (DMAC).

Peer: Redirect to CPU to allow peering depending on ECE and protocol configuration.

Forward: Allow forwarding depending on ECE and protocol configuration.

4.25 Diagnostics

The “Diagnostics” menu provides ping function to test the connectivity of a certain IP.

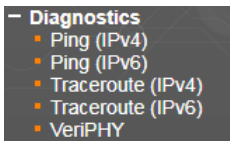

4.25.1 Ping (IPv4)

This Ping function is for ICMPv4 packets.

Hostname or IP Address: Enter the destination hostname or IP address that you wish to ping.

Payload Size: Determines the size of the ICMP data payload in bytes (excluding the size of Ethernet, IP and ICMP headers). The default value is 56 bytes. The valid range is 2-1452 bytes.

Payload Data Pattern: Determines the pattern used in the ICMP data payload. The default value is 0. The valid range is 0-255.

Packet Count: Determines the number of PING requests sent. The default value is 5. The valid range is 1-60.

TTL Value: Determines the Time-To-Live (TTL) field value in the IPv4 header. The default value is 64. The valid range is 1-255.

VID for Source Interface: This field can be used to force the test to use a specific local VLAN interface as the source interface. Leave this field empty for automatic selection based on routing configuration. Note: You may only specify either the VID or the IP Address for the source interface.

Source Port Number: This field can be used to force the test to use a specific local interface with the specified port number as the source interface. The specified port must be configured with a suitable IP address. Leave this field empty for automatic selection based on routing configuration. Note: You may only specify either the Source Port Number or the IP Address for the source interface.

IP Address for Source Interface: This field can be used to force the test to use a specific local interface with the specified IP address as the source interface. The specified IP address must be configured on a local interface. Leave this field empty for automatic selection based on routing configuration. Note: You may only specify either the VID or the IP Address for the source interface.

Quiet (only print result): Checking this option will not print the result of each ping request but will only show the final result.

After you press Start button , ICMP packets are transmitted, and the sequence number and round trip time are displayed upon reception of a reply.

The amount of data received inside of an IP packet of type ICMP ECHO_REPLY will always be 8 bytes more than the requested payload data size (the difference is the ICMP header).

4.25.2 Ping (IPv6)

Ping (IPv6)

Fill in the parameters as needed and press "Start" to initiate the Ping session.

Hostname or IP Address	<input type="text"/>	
Payload Size	<input type="text" value="56"/>	bytes
Payload Data Pattern	<input type="text" value="0"/>	(single byte value; integer or hex with prefix '0x')
Packet Count	<input type="text" value="5"/>	packets
VID for Source Interface	<input type="text"/>	
Source Port Number	<input type="text"/>	
IP Address for Source Interface	<input type="text"/>	
Quiet (only print result)	<input type="checkbox"/>	

Hostname or IP Address: Enter the destination hostname or IP address that you wish to ping.

Payload Size: Determines the size of the ICMP data payload in bytes (excluding the size of Ethernet, IP and ICMP headers). The default value is 56 bytes. The valid range is 2-1452 bytes.

Payload Data Pattern: Determines the pattern used in the ICMP data payload. The default value is 0. The valid range is 0-255.

Packet Count: Determines the number of PING requests sent. The default value is 5. The valid range is 1-60.

VID for Source Interface: This field can be used to force the test to use a specific local VLAN interface as the source interface. Leave this field empty for automatic selection based on routing configuration. Note: You may only specify either the VID or the IP Address for the source interface.

Source Port Number: This field can be used to force the test to use a specific local interface with the specified port number as the source interface. The specified port must be configured with a suitable IP address. Leave this field empty for automatic selection based on routing configuration. Note: You may only specify either the Source Port Number or the IP Address for the source interface.

IP Address for Source Interface: This field can be used to force the test to use a specific local interface with the specified IP address as the source interface. The specified IP address must be configured on a local interface. Leave this field empty for automatic selection based on routing configuration. Note: You may only specify either the VID or the IP Address for the source interface.

Quiet (only print result): Checking this option will not print the result of each ping request but will only show the final result.

After you press Start button , ICMP packets are transmitted, and the sequence number and round trip time are displayed upon reception of a reply.

The amount of data received inside of an IP packet of type ICMP ECHO_REPLY will always be 8 bytes more than the requested payload data size (the difference is the ICMP header).

4.25.3 Traceroute (IPv4)

This page allows you to perform a traceroute test over IPv4 towards a remote host. traceroute is a diagnostic tool for displaying the route and measuring transit delays of packets across an IPv4 network.

Hostname or IP Address: The destination IP Address.

DSCP Value: This value is used for the DSCP value in the IPv4 header. The default value is 0. The valid range is 0-63.

Number of Probes Per Hop: Determines the number of probes (packets) sent for each hop. The default value is 3. The valid range is 1-60.

Response Timeout: Determines the number of seconds to wait for a reply to a sent request. The default number is 3. The valid range is 1-86400.

First TTL Value: Determines the value of the Time-To-Live (TTL) field in the IPv4 header in the first packet sent. The default number is 1. The valid range is 1-30.

Max TTL Value: Determines the maximum value of the Time-To-Live (TTL) field in the IPv4 header. If this value is reached before the specified remote host is reached the test stops. The default number is 30. The valid range is 1-255.

VID for Source Interface: This field can be used to force the test to use a specific local VLAN interface as the source interface. Leave this field empty for automatic selection based on routing configuration. Note: You may only specify either the VID or the IP Address for the source interface.

IP Address for Source Interface: This field can be used to force the test to use a specific local interface with the specified IP address as the source interface. The specified IP address must be configured on a local interface. Leave this field empty for automatic selection based on routing configuration. Note: You may only specify either the VID or the IP Address for the source interface.

Use ICMP instead of UDP: By default, the traceroute command will use UDP datagrams. Selecting this option forces it to use ICMP ECHO packets instead.

Print Numeric Addresses: By default the traceroute command will print out hop information using a reverse DNS lookup for the acquired host ip addresses. This may slow down the display if the DNS information is not available.

Selecting this option will prevent the reverse DNS lookup and force the traceroute command to print numeric IP addresses instead.

4.25.4 Traceroute (IPv6)

This page allows you to perform a traceroute test over IPv4 towards a remote host. traceroute is a diagnostic tool for displaying the route and measuring transit delays of packets across an IPv4 network.

Hostname or IP Address: The destination IPv6 Address.

DSCP Value: This value is used for the DSCP value in the IPv4 header. The default value is 0. The valid range is 0-63.

Number of Probes Per Hop: Determines the number of probes (packets) sent for each hop. The default value is 3. The valid range is 1-60.

Response Timeout: Determines the number of seconds to wait for a reply to a sent request. The default number is 3. The valid range is 1-86400.

Max TTL Value: Determines the maximum value of the Time-To-Live (TTL) field in the IPv4 header. If this value is reached before the specified remote host is reached the test stops. The default number is 30. The valid range is 1-255.

VID for Source Interface: This field can be used to force the test to use a specific local VLAN interface as the source interface. Leave this field empty for automatic selection based on routing configuration. Note: You may only specify either the VID or the IP Address for the source interface.

IP Address for Source Interface: This field can be used to force the test to use a specific local interface with the specified IP address as the source interface. The specified IP address must be configured on a local interface. Leave this field empty for automatic selection based on routing configuration. Note: You may only specify either the VID or the IP Address for the source interface.

Print Numeric Addresses: By default the traceroute command will print out hop information using a reverse DNS lookup for the acquired host ip addresses. This may slow down the display if the DNS information is not available. Selecting this option will prevent the reverse DNS lookup and force the traceroute command to print numeric IP addresses instead.

4.25.5 VeriPHY

This page is used for running the VeriPHY™ Cable Diagnostics for 10/100 and 1G copper ports. Select which ports to run, or all. Click **Start** button.

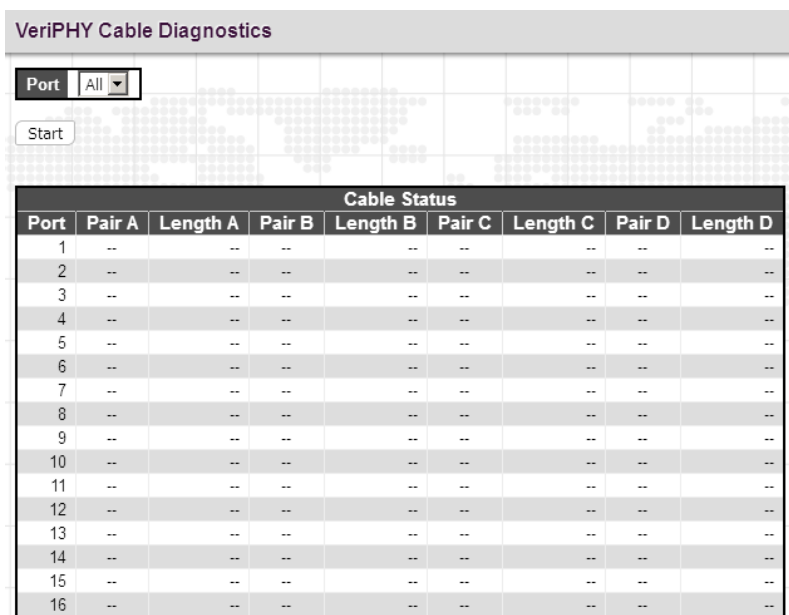

This will take approximately 5 seconds per port. If all ports are selected, this can take approximately 15 seconds. When completed, the page refreshes automatically, and you can view the cable diagnostics results in the cable status table. Note that VeriPHY is only accurate for cables of length 7 - 140 meters.

Port: Port number.

Pair: The status of the cable pair.

OK: Correctly terminated pair

Open: Open pair

Short: Shorted pair

Short A: Cross-pair short to pair A

Short B: Cross-pair short to pair B

Short C: Cross-pair short to pair C

Short D: Cross-pair short to pair D

Cross A: Abnormal cross-pair coupling with pair A

Cross B: Abnormal cross-pair coupling with pair B

Cross C: Abnormal cross-pair coupling with pair C

Cross D: Abnormal cross-pair coupling with pair D

Length: The length (in meters) of the cable pair. The resolution is ± 3 meters.

NOTE: VeriPHY is only applicable to the electrical ports. It is not applicable to the optical ports.

4.26 Maintenance

The “Maintenance” menu contains several sub menus. Select the appropriate sub menu to restart the device, set the device to the factory default or upgrade firmware image.

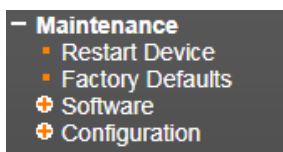

4.26.1 Restart Device

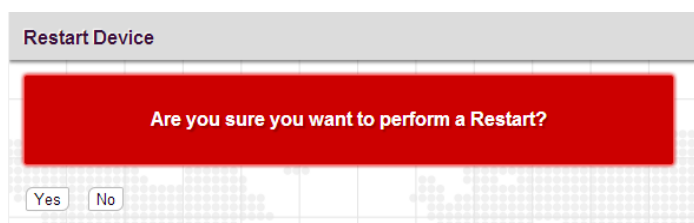

Click button to restart the switch.

4.26.2 Factory Defaults



Click button to reset your device to factory defaults settings. Please note that all changed settings will be lost. It is recommended that a copy of the current configuration is saved to your local device.

4.26.3 Software

4.26.3.1 Upload

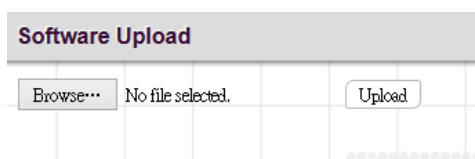

Update the latest Firmware file.

Select a Firmware file (this file should have “.dat” extension name) from your local device and then click “Upload” to start updating. The upload process will take about 5 minutes. After the Firmware file has been successfully uploaded to the switch, the switch will use the new Firmware file and reboot the switch to activate settings.

4.26.3.2 Image Select

Software Image Selection	
Active Image	
Image	linux
Version	Ver 1.04
Date	2023-05-11T15:50:03+08:00
Alternate Image	
Image	linux.bk
Version	1.04
Date	2023-02-10T15:25:46+08:00
Activate Alternate Image Cancel	

Select the image file to be used in this device.

4.26.4 Configuration

4.26.4.1 Save startup-config

Save Running Configuration to startup-config

Please note: The generation of the configuration file may be time consuming, depending on the amount of non-default configuration.

Save Configuration

Click on the **Save Configuration** button to save current running configurations to startup configurations.

4.26.4.2 Download

Download Configuration

Select configuration file to save.

Please note: running-config may take a while to prepare for download.

File Name

running-config

default-config

startup-config

Download Configuration

running-config: Download a copy of the current running configurations to your local device.

default-config: Download a copy of the factory default configurations to your local device.

startup-config: Download a copy of startup configurations to your local device.

4.26.4.3 Upload

File Name	Parameters
<input type="radio"/> running-config	<input checked="" type="radio"/> Replace <input type="radio"/> Merge
<input type="radio"/> startup-config	
<input type="radio"/> Create new file	

Select a file and then click **Upload Configuration** to start uploading the file.

4.26.4.4 Activate

Select the file that you would like to use. Click on the **Activate Configuration** to replace configurations to the selected one.

4.26.4.5 Delete

Select the file that you would like to delete. Click on the **Delete Configuration File** to remove the file from the device.

This page is intentionally left blank.



www.ctcu.com

T +886-2 2659-1021 **F** +886-2 2659-0237 **E** sales@ctcu.com